



WS-650 SERIES SPIN PROCESSOR

OPERATION MANUAL

P/N 10070119F15
October, 2011 /pg
~S/N: 11676

441 Industrial Drive
North Wales, PA 19454
215-699-7278
sales@laurell.com
support@laurell.com
www.laurell.com

Revision Date: 12/7/2011

All information contained in this manual is the property of Laurell Technologies Corporation® and is NOT to be edited, reproduced or distributed without express written permission from a corporate officer.

QUICK START INSTALLATION INSTRUCTIONS

<u>Table of Contents</u>	<u>Page #</u>
SECTION 1 – HEALTH, SAFETY AND ENVIRONMENTAL	5
1.1 LAURELL TECHNOLOGIES ENVIRONMENTAL, HEALTH AND SAFETY POLICY	6
1.2 HAZARD WARNINGS.....	6
1.2.1 LEVEL OF HAZARD INTENSITY	7
1.2.2 HAZARD PICTOGRAMS.....	8
1.2.3 HAZARD AVOIDANCE TEXT	9
1.3 EMERGENCY SHUTDOWN OPTION (STATION INSTALLATIONS ONLY).....	9
1.3.1 EMO (EMERGENCY MACHINE OFF) PROCEDURE	10
1.4 PROTECTIVE APPAREL.....	10
1.5 POTENTIAL EXPOSURE HAZARDS.....	11
1.5.1 ELECTRICAL HAZARDS	11
1.5.2 STATIC ELECTRICITY: BONDING AND GROUNDING	12
1.5.2.1 BONDING	12
1.5.2.2 GROUNDING.....	12
1.5.3 MOVING PARTS HAZARDS	13
1.5.4 AUDIO NOISE HAZARDS	13
1.5.5 CHEMICAL HAZARDS AND COMPATIBILITY	13
1.5.6 SOLVENTS	14
1.5.7 ISOPROPYL ALCOHOL.....	15
1.5.8 HYDROGEN PEROXIDE	15
1.5.9 SULFURIC ACID	16
1.5.10 HAZARDOUS WASTE	16
1.5.11 CHEMICAL DISPOSAL	17
1.5.12 ADDITIONAL SAFETY PRECAUTIONS.....	17
1.6 ENVIRONMENTAL	18
1.6.1 MATERIALS SAFETY DATA SHEETS.....	18
1.6.2 MIXING INCOMPATIBLE CHEMICALS.....	19
1.6.3 RECOMMENDED ABATEMENT TECHNOLOGY	19
1.6.4 LOCAL RESTRICTIONS (EXAMPLE)	19
1.6.5 EQUIPMENT DISPOSAL.....	20
SECTION 2 - INSTALLATION	21
2.1 FACILITY REQUIREMENTS.....	21
2.1.1 FACILITIES	21
2.1.2 POWER REQUIREMENTS.....	21
2.1.3 MAIN CIRCUIT BREAKER	21
2.1.4 DIMENSIONS.....	21
2.1.5 AMBIENT TEMPERATURE.....	21
2.1.6 CHAMBER PRESSURE	22
2.1.7 DISPENSE LIQUIDS.....	22
2.1.8 EXHAUST REQUIREMENTS	22

Revision Date: 12/7/2011

All information contained in this manual is the property of Laurell Technologies Corporation® and is NOT to be edited, reproduced or distributed without express written permission from a corporate officer.

2.1.9 VACUUM PUMP (OPTION).....	22
2.1.10 SECONDARY CONTAINMENT AND SPILL PREVENTION FEATURES.....	22
2.2 INSTALLATION	23
2.2.1 SPIN PROCESSOR CONNECTIONS	23
2.2.1.1 COMPRESSION FITTING ASSEMBLY	24
2.2.2 DIMENSIONAL DRAWINGS	24
2.2.3 DRAIN AND EXHAUST CONNECTIONS	25
2.2.4 INDECK CONNECTIONS	27
SECTION 3 - OPERATION PROCEDURES – 650 CONTROLLER.....	29
3.1 POWER	30
3.2 INTERLOCKS	30
3.2.1 LID INTERLOCK.....	30
3.2.2 VACUUM INTERLOCK.....	31
3.2.3 SEAL PURGE INTERLOCK	32
3.2.4 EXHAUST FLOW INTERLOCK.....	32
3.3 - KEYPAD.....	33
3.3.1 OPERATIONAL KEYS	34
3.4 - THE LCD DISPLAY	39
3.4.1 “SELECT PROCESS” SCREENS.....	39
3.4.2 “RUN MODE” SCREENS.....	40
3.4.2.1 “RUN MODE” – DISPLAYED FIELDS – see figure 3-11	41
3.4.2.2 “RUN MODE” – OPERATION	45
3.4.3 “EDIT MODE” SCREENS	48
3.4.3.1 EDIT MODE – DISPLAYED FIELDS – see figure 3-15	48
3.4.3.2 “EDIT MODE” – OPERATION	50
3.4.4 “INFO MODE” SCREENS	53
3.4.4.1 “INFO MODE” - STATISTICS - DISPLAYED FIELDS – see figures 3-21A & 3-21B	53
3.4.4.2 “INFO MODE” - CONFIGURATION - DISPLAYED FIELDS – see figures 3-22A-3-22E	54
3.4.4.3 “INFO MODE” - ABOUT - DISPLAYED FIELDS – see figures 3-23A	57
3.5 – PROGRAMMING THE 650 CONTROLLER	57
3.6 - RUNNING THE 650 CONTROLLER	58
3.7 - REMOVING/CHANGING CHUCKS.....	59
3.7.1 “SCREW ON” CHUCK.....	59
3.7.2 “PRESS-ON” OR “SCREW DOWN” CHUCK	59
3.7.3 HIGH PERFORMANCE DRIVE (HPD2) MOTOR - PRESS-ON OR SCREW DOWN CHUCK	61
3.8 – HIGH PERFORMANCE DRIVE MOTOR (HPD2).....	61
3.8.1 PROGRAMMING THE HPD2	61
3.9 – FIRMWARE VERSION.....	63
3.10 – WAFER SIZE vs. SPIN SPEED.....	63
SECTION 4 - MAINTENANCE.....	65

4.1 ERROR MESSAGES	66
4.1.1 VACUUM LOSS (ON UNITS EQUIPPED WITH VACUUM SENSOR ONLY.).....	69
4.1.2 REMOVING, CLEANING AND INSTALLING THE VACUUM VALVE	69
4.1.3 VACUUM CHUCK WET TEST	72
4.1.4 CLEANING AND REPLACING THE CHUCK O-RING	73
4.1.4.1 O-RING COMPOSITION, USES & RECOGNITION	74
4.1.4.2 O-RING PART LIST FOR WS-400X – xxNPP/TFM-LITE	75
4.1.5 MOTOR OPERATION.....	77
4.1.6 MOTOR CALIBRATION	77
4.2 REPLACEMENT PARTS	78
4.3 WARRANTY	78
SECTION 5 – APPENDIX	79

SECTION 1 – HEALTH, SAFETY AND ENVIRONMENTAL

INTRODUCTION

This chapter covers safety information pertaining to the spin processor system. The spin processor uses high voltage electrical power, mechanical motion, and varying temperatures in the processing of semiconductors. Safety precautions **MUST** be followed when servicing or maintaining the spin processor system.

Service and maintenance personnel should be trained in:

- Electrical safety
- Hazardous Chemical Handling
- Mechanical Motion

NOTE: Only LTC factory-trained personnel should service the spin processor system.

Some maintenance tasks may require more than one person to perform. The presence of potentially hazardous chemicals may require two or more workers to safely complete the tasks. Whenever possible turn off and lockout gases, chemical delivery valves, and electrical power before service or maintenance is performed.

Possible hazards associated with the spin processor system are:

- Electrical shock
- Inhalation, exposure, and skin contact with solvent chemicals
- Fire
- Mechanical hazards

Safety procedures associated with the spin processor are noted within this section and throughout this volume. The OEM components for your system also contain specific safety instructions, which are provided in their respective documentation.

Each spin processor is configured to use specific chemical materials in its standard process, as well as facility gases and fluids for certain maintenance tasks. These chemical materials may be hazardous, flammable and/or toxic and require careful handling. Safe handling procedures for these chemical materials are discussed in this manual.

Laurell Technologies Corporation is not liable for damages resulting from improper installation or misuse of their spin processor system. Every operator and service person must read and thoroughly understand the operation and maintenance manuals, as well as any additional information, provided by Laurell with respect to this product.

1.1 LAURELL TECHNOLOGIES ENVIRONMENTAL, HEALTH AND SAFETY POLICY

Laurell Technologies maintains an EHS (Environmental, Health and Safety) policy and will periodically notify its customers of new issues, which may affect the way in which its equipment is being used. All technical information regarding each customer and process use is entered into the company wide database. Hard copy and electronic backups are maintained as part of the company's vital information and recovery policy. This information is reviewed and updated if necessary on a daily basis.

1.2 HAZARD WARNINGS

Potential safety hazards associated with the spin processor system are clearly labeled on the equipment and in this manual using the preferred hazard-warning trilogy of alert words, pictograms, and avoidance techniques. This hazard-warning system is in accordance with ANSI Standard Z535 and OSHA 29 CFR 1910.144-147. The labels will be contained within a box border and will apply to the text immediately following the warning. (See Figure # 1-2A)

Hazard Alert Labels are subdivided into three areas:

- The Level of Hazard Intensity
- Hazard Pictograms
- Hazard Avoidance Text

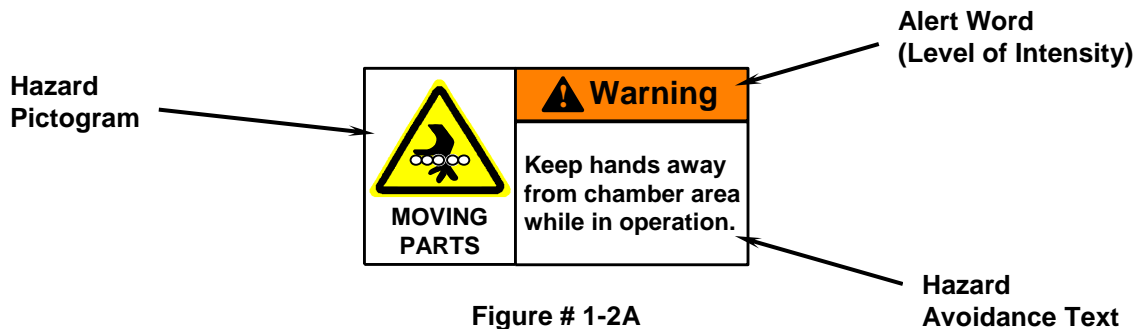

Figure # 1-2A
HAZARD ALERT LABEL

The spin processor manual uses this system of hazard warnings before each service or maintenance procedure that may involve hazards to personnel. When working on OEM sub-systems please refer to the manufacturer's documentation for specific hazard warnings. READ and UNDERSTAND precautions and hazard warnings BEFORE performing any service or maintenance task.

1.2.1 LEVEL OF HAZARD INTENSITY

Alert words are used to communicate the level of hazard intensity. The hazard alerts provided in the manual utilize some or all of the following key words:

“CAUTION”- (Depicted by black lettering on a yellow background) - This indicates potential hazard or unsafe practices or operations that could cause damage to the tool or product. Proper precautions should be taken. (See Figure # 1-2B)



Figure # 1-2B
CAUTION ALERT

“WARNING” - (Depicted by black lettering on an orange background) - This indicates that an immediate hazard exists and special precautions are necessary. Loss of life or limb may occur if WARNING labels are not heeded. (See Figure # 1-2C)



Figure # 1-2C
WARNING ALERT

“DANGER” - (Depicted by black lettering on a red background) - This indicates that an immediate hazard exists, which, if not avoided, will result in serious injury or death. (Typically not used on Laurell spin processor) (See Figure # 1-2D)



Figure # 1-2D
DANGER ALERT

NOTE: All Danger, Warning, and Cautionary notices must be carefully read, thoroughly understood and strictly observed. The users of this product assume the responsibility of implementing all Governmental, Federal, State, and Local safety regulations applicable to the use of this product.

1.2.2 HAZARD PICTOGRAMS

Hazard Pictograms (pictorial hazard alert symbols/icons) are used to visually convey the nature, avoidance technique, and possible consequences of a given hazard, if the instructions are not followed. Pictograms help assure that non-English speaking persons are alerted to potential hazards and how the hazard may be avoided.

Laurell Technologies Corporation has adopted a series of pictograms used to identify various hazards, which may be present in the spin processor. These icons appear in the manual and on the equipment wherever exposure to hazards is possible. Several may be used in each manual; however, not all pictograms are applicable to each system. Figure # 1-2E depicts some or all of the pictograms used on Laurell spin processors. Service and maintenance personnel should become familiar with all of the pictograms shown so that the hazard represented by each will be recognized on sight.

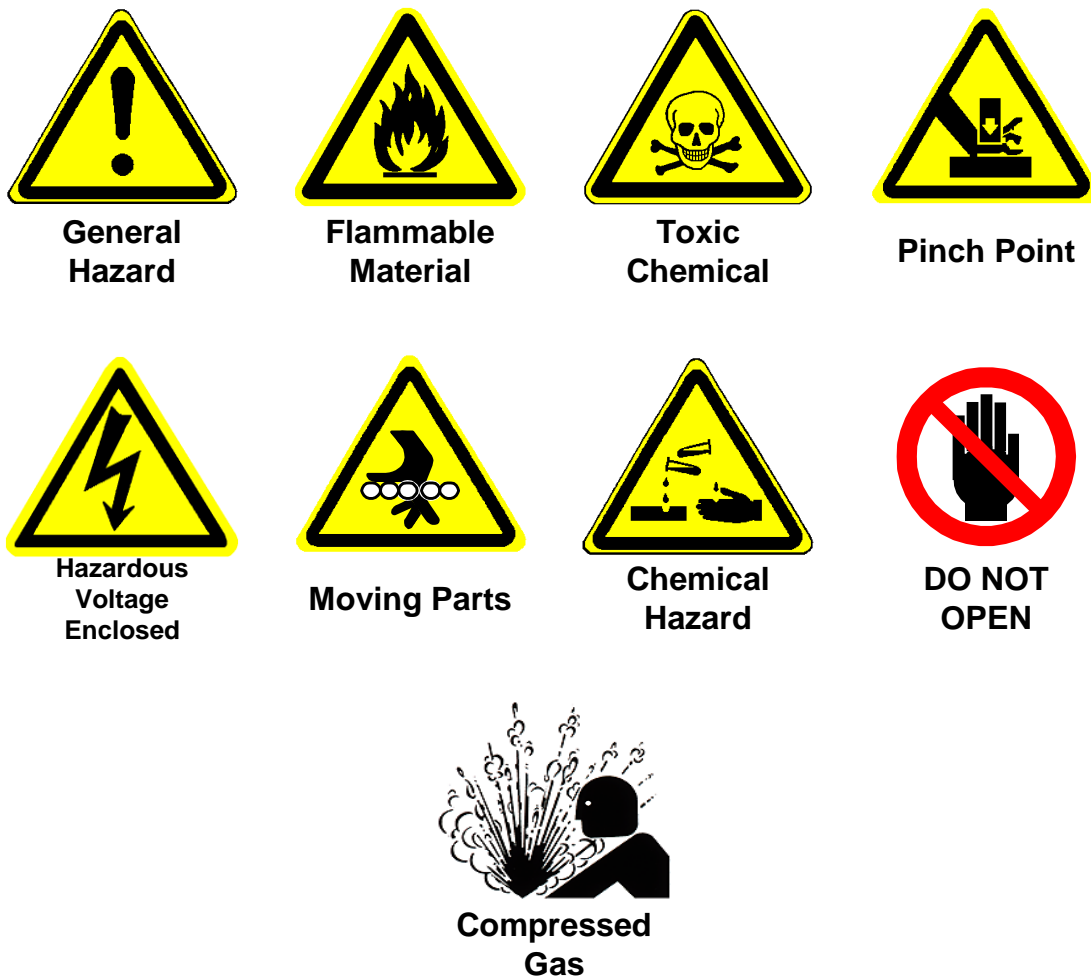

Figure # 1-2E
HAZARD PICTOGRAMS

Revision Date: 12/7/2011

1.2.3 HAZARD AVOIDANCE TEXT

Text is also used to convey methods of avoiding certain hazards and the consequences that will occur if proper precautions are not taken. (See Figure # 1-2F)



Figure # 1-2F
AVOIDANCE TEXT

1.3 EMERGENCY SHUTDOWN OPTION (STATION INSTALLATIONS ONLY)

This spin processor is **NOT** equipped with its own EMO (Emergency Machine Off) circuit; it should be powered by a system with EMO capability. If your safety department or policies allow: simply having the incoming power plug far enough away from the spin processor, properly labeled and fully accessible may be sufficient.

The EMO button area should be located within easy reach of the spin processor operator. In the event of an emergency, pressing the EMO button will remove all power to the spin processor.

After the EMO circuit has been reset and power has been restored, the spin processor will automatically reset. The spin processor will revert to the normal “power up” condition. The motor will revert to a “stopped” condition, and any process that was being performed when the EMO occurred will have been terminated. Any wafer that was being processed during this shutdown may have incurred some damage and should be treated as such.

By following the normal steps, described in Section 3.6, for initiating the spin processor, a new process may be started.

1.3.1 EMO (EMERGENCY MACHINE OFF) PROCEDURE

1. Locate the nearest EMO button.
2. Press the EMO button to immediately interrupt system power.



Figure # 1-3
EMO (Emergency Machine Off) PROCEDURE

1.4 PROTECTIVE APPAREL

Always wear personal protective equipment when handling any potentially hazardous chemicals. Use and maintenance of the spin processor may require using protective gloves, an apron, and chemical goggles and/or face shield, depending on the operation. Be sure to select protective apparel that is appropriate for the chemicals being used. Refer to your company's safety policies and procedures for the personal protective equipment required.

1.5 POTENTIAL EXPOSURE HAZARDS

The following section will cover potential exposure hazards, which may occur while operating the spin processor system.

NOTE: This section should be READ and UNDERSTOOD before using the spin processor.

1.5.1 ELECTRICAL HAZARDS

WARNING



240/115 Volts AC is used throughout the system. Do not attempt to troubleshoot or make repairs. (Refer to Section 2 for spin processor power requirements and main circuit breaker information.)

Caution: an extreme electrical hazard will exist if this system is immersed in liquid. The system must not be located where it could be accidentally knocked into any open liquid bath. An earthquake-proof base can be supplied for any system.

Electrical components are located internally, and electrical power is distributed throughout the spin processor system. Access can only be gained by removal of the bottom panel, which is secured by screws. Only LTC factory trained, qualified technicians should be permitted to work on an uncovered machine. Use all precautions and safety measures characteristically taken with AC and DC circuitry.

The spin processor should be locked and tagged out according to the procedure outlined below before any maintenance or service is performed.

Maintenance tasks are categorized by "TYPE TASK" as described below. The spin processor has no tasks that are above Type 2. The maintenance manual identifies tasks that may have electrical energy present using the following conventions:

- Type 1 - Equipment is fully de-energized (electrically "cold"). Lockout and tag-out procedures should be used.
- Type 2 - Equipment is energized. Live circuits are covered or insulated. Work is performed at a remote location to preclude accidental shock.
- Type 3 - Equipment is energized. Live circuits are exposed and accidental contact is possible. Potential exposures are less than 30 volts, 42.2 volts peak, 240 volt-amps, and 20 Joules.
- Type 4 - Equipment is energized. Live circuits are exposed and accidental contact is possible. Voltage potentials are greater than 30 volts RMS, 42.2 volts peak, 240 volt-amps, and 20 Joules, or radio frequency (RF) is present

Type 5 - Equipment is energized and measurements and adjustment require physical entry into the equipment, or equipment configuration will not allow the use of clamp-on probes.

NOTE: Unless otherwise noted, all maintenance should be performed with the spin processor system power OFF. There are NO maintenance tasks that require servicing of the spin processor while it is energized.

1.5.2 STATIC ELECTRICITY: BONDING AND GROUNDING



Friction caused by liquids moving can cause a static electricity buildup. If this charge is not properly dissipated, then fires or explosions may occur. Be sure to follow appropriate bonding and grounding practices when supplying flammable and combustible liquids to the spin processor.

1.5.2.1 BONDING

Bonding is creating a metal-to-metal connection between the dispensing and receiving containers to keep them both at the same electrical potential.

1.5.2.2 GROUNDING

Grounding is creating a metal-to-metal connection between the dispensing container and a known grounded object to allow static electricity to dissipate into the ground.

For more information on Bonding and Grounding see NFPA 77, Static Electricity.

1.5.3 MOVING PARTS HAZARDS

WARNING



Use care when opening or closing lids. Lids are heavy, and if dropped accidentally may crush or injure fingers.

WARNING



The chuck on the spin motor can spin in excess of 10,000 rpm. Keep hands and other body parts away from process chamber area. (Refer to Section 3.7 for information on changing chucks.)

1.5.4 AUDIO NOISE HAZARDS



Audible sound pressure readings were taken 3 feet (0.9 m) from the system during normal operation. The background decibel level during standby was measured to be 48 dB(A). The sound pressure readings during normal operations were measured to be 51 dB(A). Readings of less than 80 dB(A) are considered non-hazardous.

1.5.5 CHEMICAL HAZARDS AND COMPATIBILITY

The following section outlines some general guidelines for using chemicals. Refer to Section 2 for more chemical information.

CAUTION



Each spin processor is configured to use specific chemicals for its standard process and includes facility gases and fluids, and maintenance chemicals.

The use of incompatible materials in the spin processor is not allowed. If incompatible materials mix in the process chamber or in the waste streams, a hazardous and/or toxic chemical reaction may occur. It is vitally important not to mix or use incompatible materials (i.e., acids with bases, corrosives with organics, acids with organics, etc.). **Before any new chemical is used in the spin processor, the compatibility of the material with other chemicals in the system and the structural materials used in making the spin processor should be investigated.** (Refer to Section 1.6.2 for more information on incompatible chemicals.)

WARNING



WARNING



Residual chemicals may be left in the process chamber after processing has occurred. These potentially toxic or corrosive residues may pose inhalation or dermal hazards. Be sure to adequately rinse the process chamber before opening, wear appropriate personal protective equipment and ensure that the spin processor is located in a properly ventilated area that is also protected from splash hazards. (Refer to Section 2.1 for facility requirements.)

1.5.6 SOLVENTS

The following section outlines some general guidelines for using solvents.

WARNING



Most solvents are extremely flammable. Keep all flammable liquids away from ignition sources such as open flames or arcing electrical equipment. Keep all chemicals in a well-ventilated area, preferably in a cabinet designed for such storage.

WARNING



Flammable liquids should be stored and transported in approved safety cans only. When transferring flammable liquids from one container to another, be sure the pouring and receiving containers are bonded to each other and to a ground to prevent static electrical sparks. (Refer to Section 2.1.9 for secondary containment)

WARNING



Never store more than a one-day supply of flammable liquid in the using area, unless it is stored in a cabinet approved for flammable liquid storage.

WARNING



Depending on your location of use, other local fire or building code (e.g. UFC, UBC, NFPA, etc.) requirements may apply in the proper storage, dispensing, and use of flammable materials. Please consult with your local jurisdiction having authority for specific requirements. (Refer to Section 1.6.4 for local restrictions.)

WARNING



Before using solvents, read and understand the safety instructions, provided by the supplier, on the container labels and MSDS (Material Safety Data Sheets). (Refer to Section 1.6.1 for more information on Material Safety Data Sheets.)

1.5.7 ISOPROPYL ALCOHOL

WARNING



Isopropyl alcohol is a colorless liquid with an odor resembling alcohol. It causes irritation of the eyes, skin, and respiratory tract. It is extremely flammable and should be stored separately. Wear eye protection (safety glasses or a full-face shield), gloves, and an apron as recommended by your company's safety department or the manufacturer. If isopropyl alcohol gets on your skin, rinse with water for 15 minutes, refer to the manufacturer's MSDS for first aid instructions and contact your company's safety department. Use isopropyl alcohol under a fume hood or in a well-ventilated area.

Inhalation: Inhalation of vapors irritates the respiratory tract. Exposure to high concentrations has a narcotic effect, producing symptoms of dizziness, drowsiness, headache, staggering, unconsciousness, and possibly death.

Ingestion: Can cause drowsiness, unconsciousness, and death. Gastrointestinal pain, cramps, nausea, vomiting, and diarrhea may also result. The single lethal dose for a human adult = about 250 ml (8 ounces).

Skin Contact: May cause irritation with redness and pain. May be absorbed through the skin with possible systemic effects.

Eye Contact: Vapors cause eye irritation. Splashes cause severe irritation, possible corneal burns, and eye damage.

Chronic Exposure: Chronic exposure may cause skin irritation.

Aggravation of Pre-existing Conditions: Persons with pre-existing skin disorders or impaired liver, kidney, or pulmonary function may be more susceptible to the effects of this agent.

1.5.8 HYDROGEN PEROXIDE

DANGER



Hydrogen Peroxide is a strong oxidizer; contact with other material may cause fire and/or corrosive reaction. It may cause burns to skin, eyes, and respiratory tract. Harmful if swallowed.

DANGER



Before using, read and understand the safety instructions provided by the supplier on the container labels and Material Safety Data Sheets.

Inhalation: Vapors are corrosive and irritating to respiratory tract. In severe cases, exposures may result in pulmonary edema and death.

Ingestion: Corrosive and irritating to the mouth, throat, and abdomen. Large doses may cause symptoms of abdominal pain, vomiting, and diarrhea as well as blistering or tissue destruction.

Skin Contact: Corrosive. Symptoms of redness, pain and severe burn can occur.

Eye Contact: Vapors are very corrosive and irritating to the eyes. Symptoms include pain, redness and blurred vision. Splashes can cause permanent tissue destruction.

Chronic Exposure: No information found.

Aggravation of Pre-existing Conditions: Persons with pre-existing skin disorders or eye problems or impaired respiratory function may be more susceptible to effects of the substance.

1.5.9 SULFURIC ACID

DANGER



Sulfuric Acid is a poisonous and corrosive liquid. It will cause severe burns to all body tissue. It may be fatal if swallowed or contacted with skin. Harmful if inhaled. Affects teeth. Water reactive. Cancer Hazard. Strong inorganic acid mists containing sulfuric acid can cause cancer.

DANGER



Before using, read and understand the safety instructions provided by the supplier on the container labels and Material Safety Data Sheets.

Inhalation: Produces damaging effects on the mucous membranes and upper respiratory tract. Symptoms may include irritation of the nose and throat and labored breathing. May cause lung edema, a medical emergency.

Ingestion: Corrosive. Swallowing can cause severe burns of the mouth, throat, and stomach, leading to death. Can cause sore throat, vomiting, and diarrhea. Circulatory collapse with clammy skin, weak and rapid pulse, shallow respiration, and scanty urine may follow ingestion or skin contact. Circulatory shock is often the immediate cause of death.

Skin Contact: Symptoms of redness, pain, and severe burn can occur.

Eye Contact: Contact can cause blurred vision, redness, pain, and severe tissue burns. Can cause blindness.

Chronic Exposure: Long-term exposure to mist or vapors may cause damage to teeth. Chronic exposure to mists containing sulfuric acid is a cancer hazard.

Aggravation of Pre-existing Conditions: Persons with pre-existing skin disorders or eye problems or impaired respiratory function may be more susceptible to the effects of the substance.

1.5.10 HAZARDOUS WASTE

CAUTION



Normal operation and maintenance of the system creates hazardous wastes that require special handling and disposal. Disposal of these wastes must follow all codes, laws, and your company's **safety and health** requirements.



1.5.11 CHEMICAL DISPOSAL

WARNING



Never mix empty acid, flammable liquid, or oxidizer containers in the same waste cans. Chemicals must be handled in accordance with local, state and federal regulations and within the guidelines established by your company. **NEVER** dispose of chemically contaminated wipes or clothes in regular trash. Contact your companies Safety or Environmental Department for instructions on how to handle and dispose of chemically contaminated trash.



1.5.12 ADDITIONAL SAFETY PRECAUTIONS

Full compliance with the following safety practices and those appearing earlier in this chapter is expected.

1. Never work alone on live electrical circuits. You must be within sight or calling distance of another employee who has the following qualifications:
 - Knows how to remove power from the equipment.
 - Knows how to apply artificial respiration.
 - Is acquainted with emergency procedures, first aid locations, and the location and use of fire extinguishers.
2. Turn off, lockout, and tag all hazardous energy sources (e.g., gas, pneumatic, mechanical, gravitational, and electrical) before performing any maintenance.
3. Do not wear rings, wristwatches, or other jewelry on your hands or arms while working on live electrical circuits.
4. Wear eye protection while working on live electrical circuitry where a flash might occur. Do not wear contact lenses.
5. Replace all safety shields after completing setup, troubleshooting, and maintenance procedures.
6. Immediately report any unsafe conditions to your supervisor.
7. Comply with all applicable regulations governing the disposal of hazardous materials. Dispose of waste materials in a manner that will prevent air or water pollution and will not expose humans, animals, or vegetation to hazards.
8. Do not permit smoking or food in the work area.

9. Secure electrical cords and cables where they cannot be tripped over or otherwise accidentally pulled from their connectors.
10. Be sure that all personnel know the location of the main circuit breaker in case of an electrical emergency.
11. Locate fire extinguishers near the equipment. The extinguishers must be approved for electrical or chemical fires in accordance with OSHA and local, state, and federal codes.
12. Operating personnel must NOT remove covers or panels. Only qualified maintenance personnel may make component replacements and internal adjustments only.
13. Do not replace components with the power cable connected. Under certain conditions dangerous voltages may exist, even when the power cable is removed. To avoid injuries, always disconnect power; lock out the circuit breaker and discharge circuits before performing a task.
14. Do not attempt internal service or adjustment unless a person capable of rendering first aid is present. Be sure to follow your company's safety procedures.
15. Because of the danger of introducing additional hazards, do not install substitute parts or make any unauthorized modification to the system.
16. Contact Laurell Field Service for service and repair to ensure that safety features are maintained.
17. Maintain adequate safety precautions when handling toxic chemicals. Avoid breathing dust or spray mist. Use chemicals only with adequate ventilation and keep containers closed when they are not in use. Store chemicals in a locked cabinet where they cannot be removed accidentally.

1.6 ENVIRONMENTAL

1.6.1 MATERIALS SAFETY DATA SHEETS

Before introducing any new chemical, consult the factory specifications. The chemical manufacturer or supplier provides MSDS (Material Safety Data Sheets) for each chemical. The MSDS gives vital chemical safety information on the hazardous components, the chemical's physical properties, spill and leak procedures, waste disposal information, and personal protective equipment required to handle the chemicals involved. Follow the information on the MSDS when handling, refilling chemical containers or cleaning up spilled or leaked materials. Before using solvents, read and understand the safety instructions provided by the supplier on the container labels and MSDS.

NOTE: Laurell Technologies Corporation recommends that copies of the MSDS be kept with this manual and be made available to your employees. There are several websites dedicated to providing chemical information. For reference, Laurell has listed the following:

- www.hazard.com/msds/
- <http://webbook.nist.gov/chemistry>

1.6.2 MIXING INCOMPATIBLE CHEMICALS

It is important not to mix incompatible materials in the process chamber and/or waste stream of the spin processor (i.e., mixing acids with bases, corrosives with organics, and acids with organics...). Mixing incompatible materials can result in unwanted chemical reactions in either the chamber, exhaust or drain line. Only compatible materials are recommended for use within the spin processor system. Before any new chemical is used, compatibility of the material with other chemicals in the system and the materials used to construct the spin processor should be investigated. Some of this information may be obtained from the MSDS or the chemical supplier.

NOTE: Use of incompatible materials in the spin processor is strictly forbidden and should not be done under any circumstances.

1.6.3 RECOMMENDED ABATEMENT TECHNOLOGY

The vapor by-products expected in the effluent of the spin processor system should be handled and disposed of in accordance with any and all safety and legal abatement procedures. The recommended abatement technologies for efficient removal of hazardous process by-products are solvent destruction or solvent recovery. Several methods exist that are capable of removing the process by-products from the effluent stream. Some are reportedly more effective than others in terms of efficiency. The oldest abatement technology is to exhaust this effluent into the house *solvent* system, which is normally present in a wafer manufacturing facility.

The trend of the industry is to abate the process by-products at the *point-of-use* (POU), which localizes containment of the process effluent allowing ease of handling. Various POU technologies, as described below, are available for controlling these process by-products.

- *Thermal-oxidizers* convert the effluent gases into other compounds using either flame combustion or a heated catalytic process. The flame combustion requires fuel (usually hydrogen or natural gas) to maintain the flame.
- POU *dry scrubbers* are chemical-absorbent materials that capture the effluent onto absorbent granules. The benefits of dry scrubbers include cost effectiveness, non-hazardous cartridge disposal, and, if available, recycling or recovery of the solvent as a liquid.

More information on abatement technologies may be obtained from Semiconductor Safety Association (a trade group) at (703) 790-1745 or <http://seshaonline.org/>

1.6.4 LOCAL RESTRICTIONS (EXAMPLE)

The use of IPA (Isopropyl Alcohol) creates an environmental concern. Certain local jurisdictions have limitations on, and/or require permits for, the use of organic cleaning solvents. For example, the San Francisco Bay Area Air Quality Management District (BAAQMD) Regulation 2.1.118 limits the amount of volatile organic wipe cleaning solvents that may be used without obtaining a specific permit to 20 gallons per year per source area. Regular wipe down of the spin processor components could exceed this regulation's exemption limits alone or most likely when combined with similar operations at an end-user's facility.

1.6.5 EQUIPMENT DISPOSAL

It is well known fact that electrical and electronic products can pollute the environment by releasing toxic compounds from component decomposition after equipment disposal (in a landfill for instance). The aim of the European RoHS directive is to reduce the potential release of toxic substances from electronic products into the environment. All of Laurell's products sent to the EU community conform completely to the RoHS directive. The intent of the European WEEE (Waste Electrical and Electronic Equipment) directive is to force the recycling of electrical and electronic products as opposed to disposal as normal refuse. Controlled recycling of products after the end of their useful life will thereby avoid all negative impact on the environment.

We also feel that this is a very important consideration for all of our customers, no matter where the end user is located. We at Laurell Technologies support all efforts to safely dispose of all contaminated products and to minimize any and all potential environmental pollutants.

As required by the WEEE Directive of the European Union and the corresponding national laws, Laurell Technologies Corporation offers all end users in the EC and around the world the option to return, post paid, "end of life" spin processors without incurring any disposal charges.

If you wish to return a Laurell Technologies spin processor for waste recovery, please contact our home office at: support@laurell.com or call (215)699-7278.

If you do not return an "end of life" spin processor to Laurell Technologies, you must use a disposal company specializing in electronic waste recovery. Do not dispose of the spin processor as normal public refuse.

SECTION 2 - INSTALLATION

2.1 FACILITY REQUIREMENTS

2.1.1 FACILITIES

- The spin processor should be installed on a vibration free surface in a clean, temperature and humidity controlled environment to provide the best conditions for repeatable processing results.
- Seal Purge - N₂ or CDA (Clean Dry Air) 60 - 70 psi (4.1 – 4.8 bar). N₂ or CDA must be moisture free. If moisture is present install an air dryer type filter. For particulate control it is recommended that a point of use filter, 1 micron, or less, be installed after the regulator and before the processor. The seal purge tubing **MUST NOT BE “T”** to supply another output from the same regulator.
- Vacuum - 20 – 28” Hg with a flow volume of 1.6 - 4.5 SCFM @ 0” Hg. Other conversions see below.

20”Hg -	28”Hg or,	1.6 -	4.5scfm or,
0.68bar	0.95bar or,	0.047cm ³ /m	0.11cm ³ /m or,
68kpa	95kpa or,	47Lpm	127Lpm
508torr	711torr		

- Exhaust see section 2.1.8 below
- Drain – Open to atmosphere – NOT restricted by a vapor trap (see Figure 2-2C)

2.1.2 POWER REQUIREMENTS

- Power – 95 to 240VAC, 47/63HZ, 3 amps, 300 watts. A 15 foot (~200cm) power cord with a 3 pronged plug is supplied with an appropriate country plug adapter if necessary. All of our present designs have universal voltage input capability.

2.1.3 MAIN CIRCUIT BREAKER

- The circuit breaker on the spin processor is rated for 200A-interrupt current capacity. SEMI S2 requires a minimum of 10,000 AIC for the main disconnect. The end-user of the spin processor system should install a suitably rated circuit breaker (minimum 10,000 AIC) for the circuit if they wish to meet SEMI S2 requirements

2.1.4 DIMENSIONS

- See Appendix for Basic System Dimensions and Installation Diagrams.
- Additional space will be required for pressure vessels and pneumatic fluid/N₂ control valves.

2.1.5 AMBIENT TEMPERATURE

- The Spin processor is designed to run in an ambient temperature of between 68 - 75° F (20 -24° C).

2.1.6 CHAMBER PRESSURE

- When optional exhaust is supplied to the chamber it should be maintained at an operational negative pressure of ≥ 0.5 inches (5.08mm) of H₂O. Actual exhaust flow which provides optimal processing results is user defined. The exhaust flow can be controlled by our optional down flow exhaust adapter.

2.1.7 DISPENSE LIQUIDS

- Automatic or manual syringe (optional)

2.1.8 EXHAUST REQUIREMENTS

- The spin processor is intended for use in an exhausted bench area. The end user is responsible for providing exhaust for the bench area.

	Volumetric Flow rate (CFM)*	Static Pressure (in H ₂ O)*	Duct Material	Type of Exhaust
Solvent Storage Cabinet	Solvent Storage Cabinet not supplied by Laurell			
Chamber Drain Port	25 (.71M ³)	.5 to 2.5"	PP	Chemical / Solvent

Note: These measurements were taken in the exhaust duct 3 inches from the system after the first elbow.

2.1.9 VACUUM PUMP (OPTION)

- LTC provided oil-less vacuum pump:
 - 25 – 28" (635 – 711mm) Hg with a flow volume of 4.5 scfm (0.11cm/m) @ 0"Hg
 - Power - 100 – 115 or 220 – 230 VAC - 50 / 60 Hz.
 - It is recommended to install the pump in an open and well ventilated area. Normal operating temperature after 1 hour of use is $75 \pm 5^{\circ}\text{C}$ ($165 \pm 9^{\circ}\text{F}$). Pump is design for continuous use. The factory thermal protection interlock is sensed on the motor windings and set for $135 \pm 5^{\circ}\text{C}$ ($275 \pm 9^{\circ}\text{F}$). The thermal reset temperature is $61 \pm 9^{\circ}\text{C}$ ($142 \pm 16^{\circ}\text{F}$). **Caution:** Pump will be hot after continuous use. Allow time for cooling before handling pump.
- Pneumatic Vacuum Generator (IVPVG)
 - Air pressure driven, variable, vacuum generator
 - N₂ or CDA ≤ 60 psi (4.1 bar) required. We recommend a dedicated pressure regulator.
 - For more information go to <http://www.laurell.com/accessories/iv-pvg.php>

2.1.10 SECONDARY CONTAINMENT AND SPILL PREVENTION FEATURES

- When installed at the end-user site, secondary containment is recommended. It should provide for the spin processor and the pressurized tank(s). All secondary containment should incorporate appropriate gas detection, liquid sensors, and alarms. If incompatible materials are used in the spin processor, (not

recommended by Laurell) containment should be designed to ensure that the materials could not be combined. Automatic shutoff capability should be considered for bulk distribution systems. The secondary containment provided should be able to contain 110% of the volume of the largest single container or all vessels combined.

2.2 INSTALLATION

SEE FRONT OF MANUAL FOR “QUICK START INSTALLATION INSTRUCTIONS”.

The first step in the installation is to unpack the spin processor. Identify each component on the packing list and verify that it was not damaged during shipping. Any loss or damage must be reported to the factory within 30 days from shipment.

Refer to section 2.1 “Facility Requirements” for required electrical power, vacuum, drain, exhaust, and N₂ or CDA (Clean Dry Air). Since each spin processor is configured to meet the needs of the end-user, requirements will vary for each application. It is recommended that a point-of-use filter (≤ 1 micron), a pressure regulator and a check valve (5 PSI breaking pressure) be installed on all supply tubing connected to the spin processor. Refer to installation drawing(s) in Section 5 for guidance.

2.2.1 SPIN PROCESSOR CONNECTIONS

- Follow the outline in section 2 “Facilities” to prepare for installation. Use dedicated regulators and filters where appropriate.
- **See “Quick Start Instructions” in front of manual for step-by-step installation instructions.**
- Install the processor on a stable, level and vibration free surface.
- Connect drain line to rear of spin processor’s drain adapter. **See Quick Start Instructions.**
- Connect vacuum source, using the provided 3/8” (9.52mm) O.D. x 1/4” (6.35mm) I.D. tubing, to the 3/8” fitting on the vacuum control valve (right rear side of spin processor). (Applicable only if vacuum-type chuck is used.) **Note: vacuum supply tubing should be 1/4” I.D. or larger to provide sufficient volume quickly. See Quick Start Instructions.**
- Connect 1/4” O.D. tubing for Seal Purge to N₂ or CDA regulator. Set regulator to 60 -70 psi. **See Quick Start Instructions.**
- Connect power cord to an appropriate AC source. Note: the circuit breaker, located on the back of the processor, is also a power switch, which when pressed and the button is extended, will turn the system off.

“Installation Safety - Caution”

WARNING



Caution: an extreme electrical hazard will exist if this system is immersed in liquid. The system must not be located where it could be accidentally knocked into any open liquid bath. An earthquake-proof base can be supplied for any system.

Revision Date: 12/7/2011

2.2.1.1 COMPRESSION FITTING ASSEMBLY

FITTING ASSEMBLY

This diagram will guide you in the proper assembly of your system fittings. Although your fitting may not match the picture exactly, all fittings follow the same installation arrangement. There is no need to use Teflon tape on any of the fittings. All fittings only need be hand-tightened for a proper seal.

ASSEMBLY INSTRUCTIONS

Please follow these diagrams in assembling nuts.
As shown below, insert gripper (B) into nut (A).
Push sleeve (C) into nut assembly.

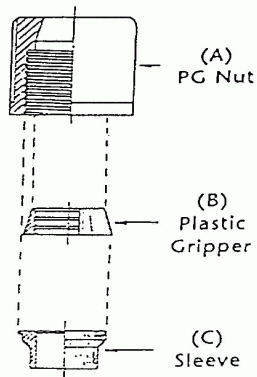

2.2.2 DIMENSIONAL DRAWINGS

Dimensional drawings of all of our systems can be found at

<http://2k10.laurell.com/spin-coater/models.php>
<http://2k10.laurell.com/accessories/mounting.php>

2.2.3 DRAIN AND EXHAUST CONNECTIONS

Figure 2-2A is the drain only configuration. Exhaust is optional on the LITE model. Figure 2-2B is the down-flow exhaust option. An exhaust source of approximately 0.5” to 2.5” H₂O column, as measured with a differential pressure gauge, is sufficient for processing. Figure 2-2C is our standard exhausted drain cup assembly. Figure 2-2D is a drawing of the recommended drain configuration.



Figure 2-2A
Standard Configuration

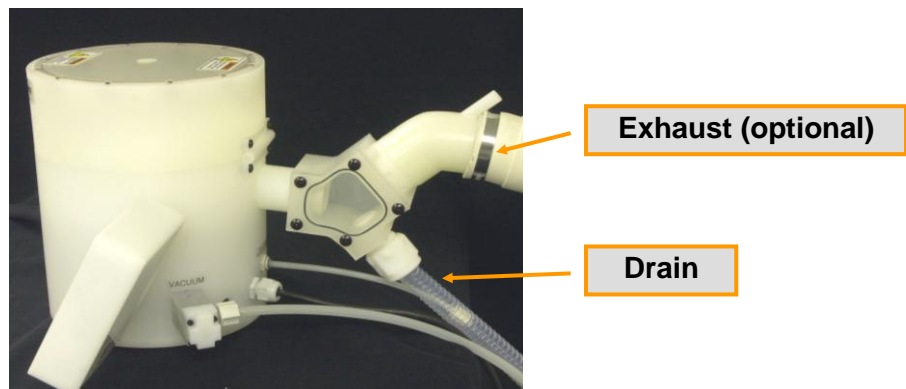

Figure 2-2B
Optional Exhausted Drain Assembly

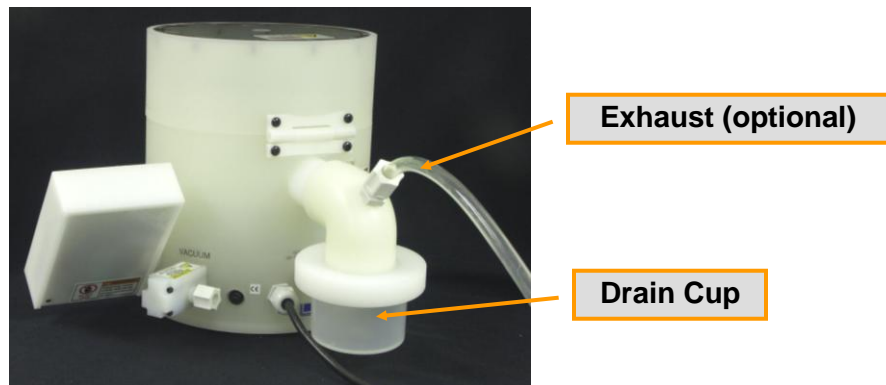

Figure 2-2C
Optional Exhausted Drain Cup Assembly

Revision Date: 12/7/2011

All information contained in this manual is the property of Laurell Technologies Corporation® and is NOT to be edited, reproduced or distributed without express written permission from a corporate officer.

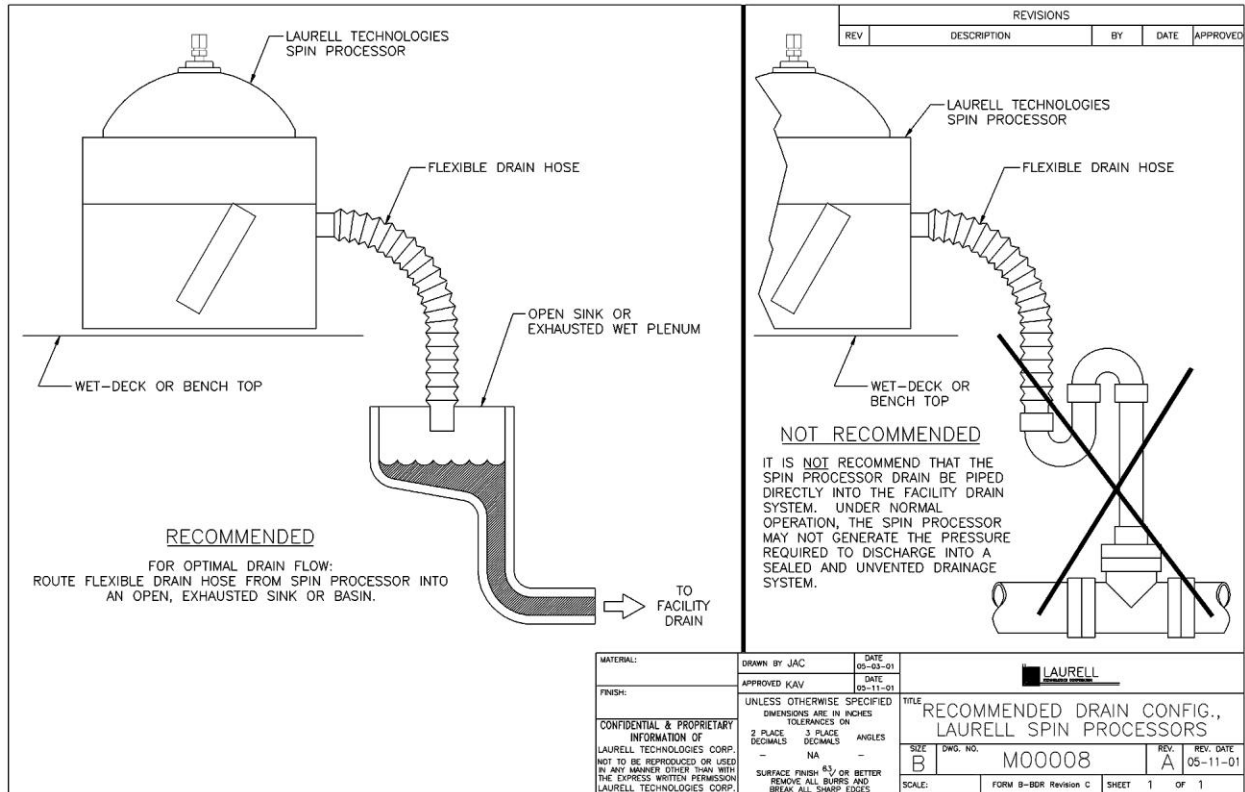

Figure 2-2C
RECOMMENDED DRAIN CONFIGURATION

Revision Date: 12/7/2011

2.2.4 INDECK CONNECTIONS

Indeck installations require cabling the remote control box assembly to the spin processor. Two cables and one vacuum sensor hose are required, which can be detached at the rear of the remote control box (see photo below, Figure 2-3A, for plumbing and electrical hook-up).

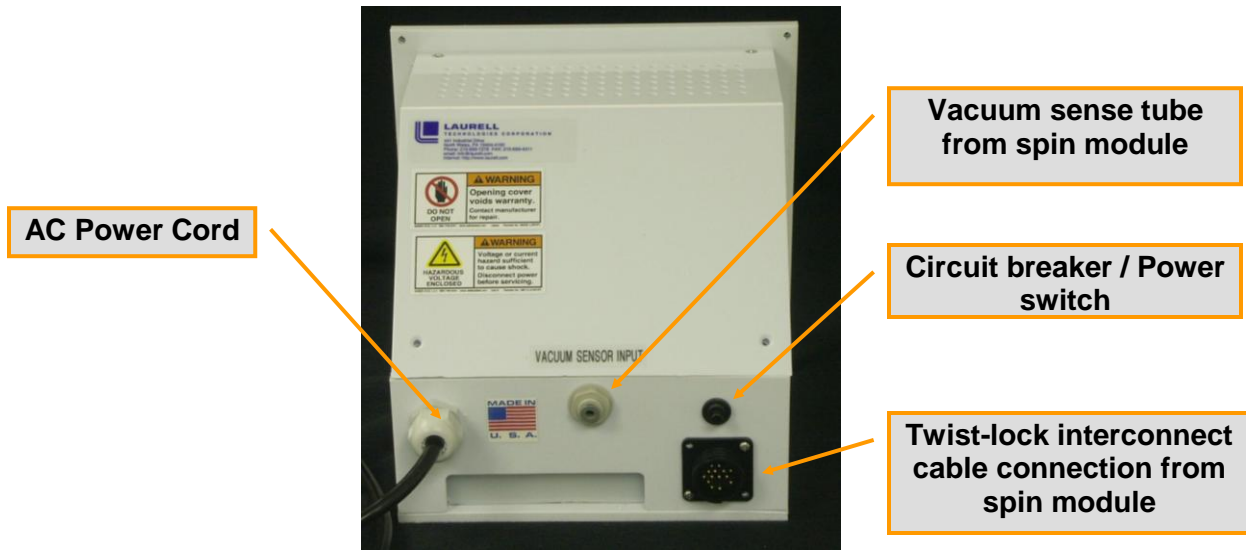

Figure 2-3A
INDECK CONTROLLER – REAR VIEW

The spin processor vacuum connection and drainpipe are located on the bottom of the spin processor housing (see photo below, Figure 2-3B, for plumbing and electrical hook-up).



Figure 2-3B

Revision Date: 12/7/2011

All information contained in this manual is the property of Laurell Technologies Corporation® and is NOT to be edited, reproduced or distributed without express written permission from a corporate officer.

SECTION 3 - OPERATION PROCEDURES – 650 CONTROLLER

GENERAL

The 650 controller will operate with two types of spin motors. The standard performance motor drive is designated 650M and the high performance motor (HPD-2) is designated 650H. Only the HPD-2 motor has bidirectional rotation and agitation capability. This difference is more fully explained later in this section (see section 3.4.3.1 Acel – Standard Drive).

All operational controls are interfaced through the spin processor's membrane switch keypad and the LCD (Liquid Crystal Display). There are 4 operation modes available to the user. They are; "Select Process", "Run", "Edit" and "Info". The capabilities of the 650 controller are greatly enhanced with the Spin 3000 software. Certain set points and configurations can only be assigned through Spin 3000. Figure 3-1 is an example of the "Run Mode" screen. Relevant information specific to the operation mode selected is displayed. (See Section 3.3 – "Keypad" for illustrations.)

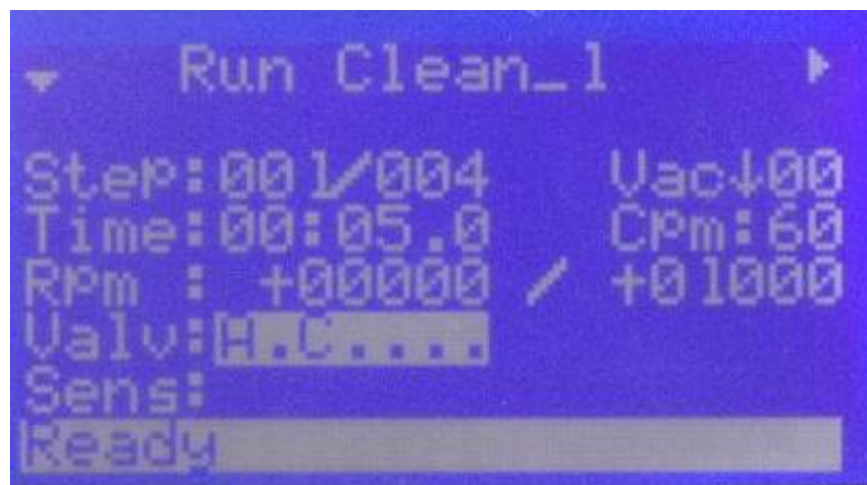

Figure 3-1
RUN MODE DISPLAY

Lists of process programs are available in the "Select Process" mode. Up to twenty (20) process programs, containing up to fifty-one (51) steps each can be permanently stored in non-volatile memory in the 650 controller. Many more programs can be stored in Spin 3000. When an operation mode key is pressed, such as "Select Process" or "Run", all active keys LEDs' become illuminated. When the "Run" operation is selected the operation mode/program name, step-of-steps, vacuum status, set point time, agitation rate, actual wafer rpm, set point rpm and spin rotation direction, valve, sensor and type status and processor's status for each step of a program are displayed. In the "Edit Mode" each program step includes: operation mode/program name, step-of-steps, vacuum status, set point time, agitation rate, set point rpm and spin rotation direction, acceleration rate (acceleration / deceleration rate is shown in edit mode only) and valve, sensor and type status. The "Info" key when pressed provides information on "Statistics", "Configuration" and "About" the spin processor.

Revision Date: 12/7/2011

A vacuum interlock assures that vacuum is activated before any program requiring vacuum can run. Vacuum will not disengaged until the wafer comes to a complete stop. Units are equipped with a vacuum sensor to additionally ensure that sufficient vacuum is provided to hold down the substrate during processing. A safety lid interlock inhibits opening the lid while a process is running. Additionally, if the lid interlock is overcome, motor rotation and valve actuation is turned off if an open lid condition is detected. A design feature is included to avoid the accidental re-running of a process on the same wafer. In order to run a program twice on the same substrate, the lid must be opened or the program must be changed. If you desire to run the same substrate more than once simply press the edit key then the run key will allow another program cycle to be enabled without opening the processor. Vacuum to a substrate will automatically shut down after 10 minutes of non-use or when the lid is opened.

3.1 POWER

All units are equipped with a single pole over current circuit breaker with manual reset. This breaker is located on the body of the spin processor housing near the AC cord entry location (Indeck systems have the breaker switch on the remote controller's rear panel). Seeing the white band of the "reset" button is indicative that the power has been interrupted. During normal operation, the circuit breaker should never trip. If the circuit breaker does trip, a visual and mechanical inspection of the unit should be performed before resetting the circuit breaker. This circuit breaker also serves as an "ON/OFF" switch for the unit. Pressing the "reset" button will toggle power on and off to the unit.

3.2 INTERLOCKS

3.2.1 LID INTERLOCK

A lid interlock is provided to disable the spin processor's motor and dispense operation when the lid is in the open position. If the lid is opened while running, the program will be safely interrupted, the pilot air valves will be disabled and the chuck will stop slowly. "LID OPEN" notes this condition in a message displayed on the last line of the run screen on the LCD display. (See Figure 3-2) The program can be continued from the point at which it stopped by closing the lid and pressing the **START** key.



Figure 3-2
"LID OPEN" ERROR MESSAGE

3.2.2 VACUUM INTERLOCK

Two conditions must be met to allow operation of systems equipped with a vacuum hold down type chuck. **The first condition that must be present is a vacuum source with vacuum ≥ 15 "Hg.** A factory preset sensor, set in Spin 3000, will not allow the system to operate with vacuum < 15 "Hg. This interlock insures that adequate vacuum is applied to the substrate. Inadequate vacuum will cause an unsafe condition and may cause a substrate to spin off the chuck and cause breakage. A "**Need Vacuum**" message (measured in inches of Hg) is an indication that this requirement has not been met. (See figure 3-3) Without the required amount of vacuum, a process cannot be started. If the vacuum falls below the required level while a process is running, the program will be halted at that point and a "**Low Vacuum**" error message will appear on the LCD display¹. Once vacuum has been re-established it is necessary to press the **START** key on the keypad to re-start the program from where it stopped. The vacuum set point is user defined in Spin 3000.



Figure 3-3
"NEED VACUUM" ERROR MESSAGE

The second required condition, which **MUST** be present for the air operated vacuum valve to function, is sufficient seal purge pressure. Since the vacuum valve is pneumatic it must have enough N₂ to operate. See section 3.2.3. If there is insufficient N₂ pressure the controller will display "**Need CDA**" and "**Need Vacuum**" indicating no N₂ or vacuum. See Figure 3-4 for an illustration of this condition. If there is < 60 psi of N₂ the vacuum screen may show that there is vacuum ≥ 15 "Hg but the lack of N₂ will display "**Need CDA**".

¹ See Section 4.1 - Errors



Figure 3-4
“NEED CDA” ERROR MESSAGE

WITHOUT THE PROPER N₂ PRESSURE THE SYSTEM WILL NOT OPERATE.

Press the VACUUM button on the keypad to turn on/off the vacuum valve. Once actuated, and a program is running, the vacuum valve cannot be turned off until the motor is stopped @ 0 RPM for 1 second. This safety feature insures that vacuum cannot be inadvertently turned off until the chuck comes to a complete stop.

3.2.3 SEAL PURGE INTERLOCK

All of our systems require at least 60 - 70 psi (4.13 – 4.83 bar) of CDA or N₂ to pressurize the labyrinth motor seal. **If Nitrogen is < 60 psi (4.13 bar) the processor WILL NOT OPERATE.** The seal’s purpose is to separate the process chamber from the motor and electronics in order to insure long service-free operation. The gas consumption is very low (≈3.0 cubic feet per hour). **We recommend a constant CDA/N₂ supply even when the processor is not in use.** An interlock pressure sensor monitors nitrogen pressure. This interlock will report a “**Need CDA**” error if the pressure should drop below the 60 psi requirement during operation. The interlock will not allow a new process to begin until the minimum pressure of 60 psi is met. If the purge falls below the required level while a program is running, the program will be halted at that point, and a “**Need CDA**” will appear on the LCD display², figure 3-4. Once purge pressure has been re-established, it is necessary to press the **START** key on the keypad to re-start the program.

3.3.4 EXHAUST FLOW INTERLOCK

For optimum performance and to prevent possible motor damage it is very important to monitor exhaust flow. The EDC model comes with a digital differential pressure gauge to monitor exhaust flow. The exhaust controller’s lower and upper exhaust flow set points have been preset at the factory. The lower set point is 0.5” of H₂O and the upper set point has been set to 5.0” of H₂O. See section 2.3.2 to properly balance the dome purge and exhaust flow.

Figure 3-14 shows an example of a “low exhaust” error message.

² See Section 4 - Errors

3.3 - KEYPAD

All operator actions are initiated through the membrane switch keypad, figure 3-5.

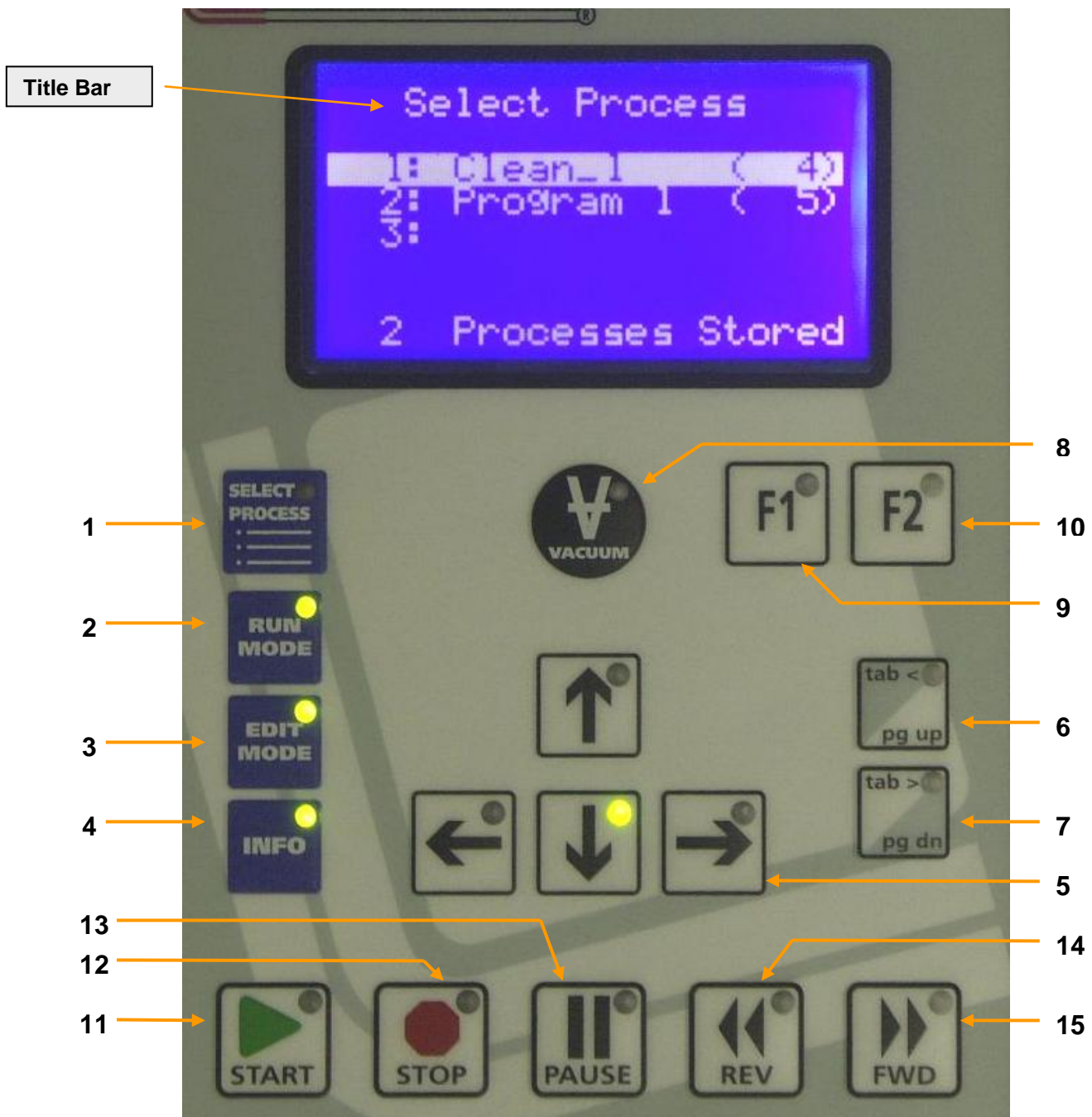

Figure 3-5
KEYPAD



NEVER flood or spray solvent such as acetone or any other type of cleaner directly onto the keypad surface. Doing so may cause keypad failure. Always wet a wipe or cloth with the solvent and gently wipe the keypad surface.

Revision Date: 12/7/2011

All information contained in this manual is the property of Laurell Technologies Corporation® and is NOT to be edited, reproduced or distributed without express written permission from a corporate officer.

3.3.1 OPERATIONAL KEYS

1 – SELECT PROCESS MODE – press this key to list all process programs stored within the 650 controller. This key is active when the green LED is illuminated. When the “select process” mode is selected a number of keys become active as indicated by illuminated green LEDs. These illuminated keys can be used to navigate the keyboard and display. Using the select process mode key the user can select the “Run Mode” (2), Edit Mode (3) or “Info Mode” (4). The “Up arrow (↑)” and “Down arrow (↓)”keys (5) can be used to move from line-to-line.

Each line displays the ten-character program name followed by how many steps the program has, in parentheses. See figure 3-6

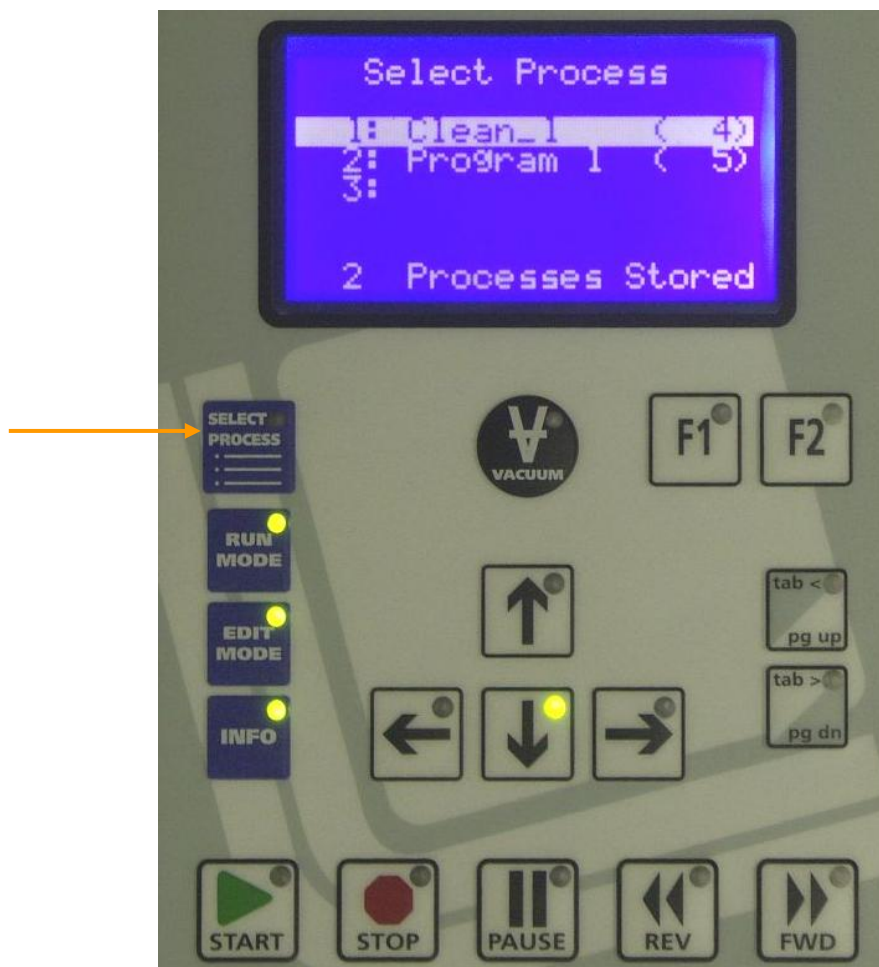

Figure 3-6
SELECT PROCESS SCREEN

Twenty (20), 51 step programs can be stored in the 650 controller. Many more can be stored in Spin 3000. The last line of the display shows the total number of resident programs within the 650 controller.

2 – RUN MODE – press this key to enter a selected program from the “Select Process” screen into the “run mode”. This key is active when the green LED is illuminated. The start key (11) is active; pressing this key will begin processing. Figure 3-7 shows the “Run Mode” screen. When the “run mode” is selected a number of keys become active as indicated by illuminated green LEDs. From the “Run Mode” the user can enter the “Select Process Mode”, Edit Mode” or “Info Mode”. The “Up Arrow (↑)” and “Down Arrow (↓)” keys can be used to move between “Valv”, “Sens” and “Type” line. The F1 key (9) becomes active when the “Valv” or “Sens” line is highlighted. The F1 key will send the user to the valve or sensor submenu. Vacuum (8) can be turned on or off.

Displayed fields are the operation mode/program name, step-of-steps, vacuum status, set point time, agitation rate, actual wafer RPM, set point RPM and spin rotation direction, valve, sensor and type status for each step of a program. The last line of the display will show the processor status and error messages.

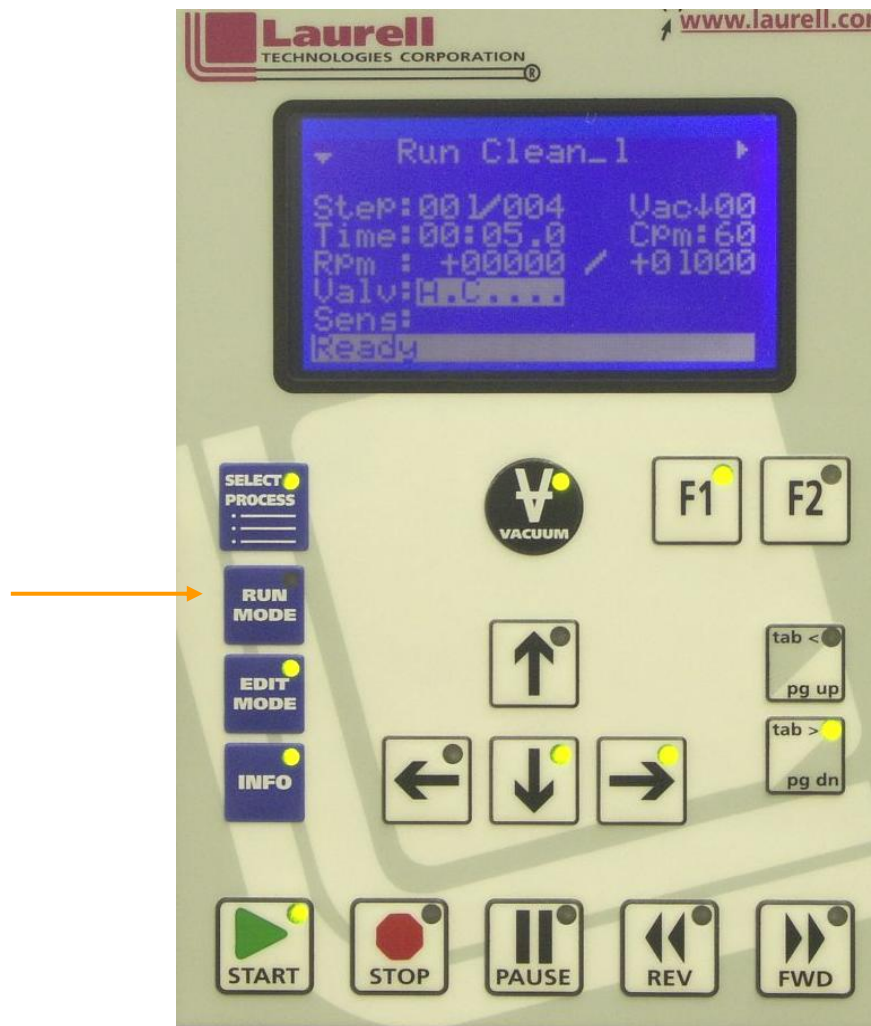

Figure 3-7
RUN MODE SCREEN

3 – EDIT MODE – press this key to create a new program or to select an existing program for modification. This key is active when the green LED is illuminated. Figure 3-8 shows the “Edit” mode screen. From the “Edit Mode” the user can enter the “Select Process Mode”, Run Mode” or “Info Mode”. The “Up Arrow (↑)” and “Down Arrow (↓)” keys can be used to move from line-to-line. The “Tab <” (6) or “Tab >” (7) keys can be used to switch the highlighted field into an “*editable*” field. The “FWD” (15) or “REV” (14) keys are used to move from step-to step with in a program. Vacuum can be turned on or off.



**Figure 3-8
EDIT MODE SCREEN**

Editable fields are: the step number, number of steps, step duration, spin speed, acceleration, motor direction, vacuum requirement, agitation rate, valves’ state, and sensors’ state. Each field is highlighted when it is selected. Figure 3.8 shows the first field, step number, highlighted. Use the “Up Arrow (↑)” and “Down Arrow (↓)” navigational keys to move from line to line. The “Tab<” and the “Tab>” key when pressed enables the highlighted field to be *editable*. When a “Tab<” or “Tab>” key is pressed the highlighted field will blink, this is an indicator that the field is now changeable. When a “Tab<” or “Tab>” key is pressed the blinking cursor will move from field to field within a program. The “Up Arrow (↑)” and “Down Arrow (↓)” keys will change the value or state of an *editable* field. The ←(Left) & →(Right) keys are used to move within fields with many digits such as speed. When the valve or

sensor field is highlighted the F1 key becomes active to allow access to their respective submenus.

4 – INFO – press this key to view “Statistical”, “Configuration” and “About” information. This key is active when the green LED is illuminated. Highlight the desired field and press the F1 key to enter each submenu. Figure 3-9 shows the “Info Mode” menu screen. From the info mode the user can enter the “Select Process Mode”, Run Mode” or “Edit Mode”. The “Up Arrow (↑)” and “Down Arrow (↓)” keys can be used to move from line-to-line. The F1 key when pressed shows the information associated with each line.

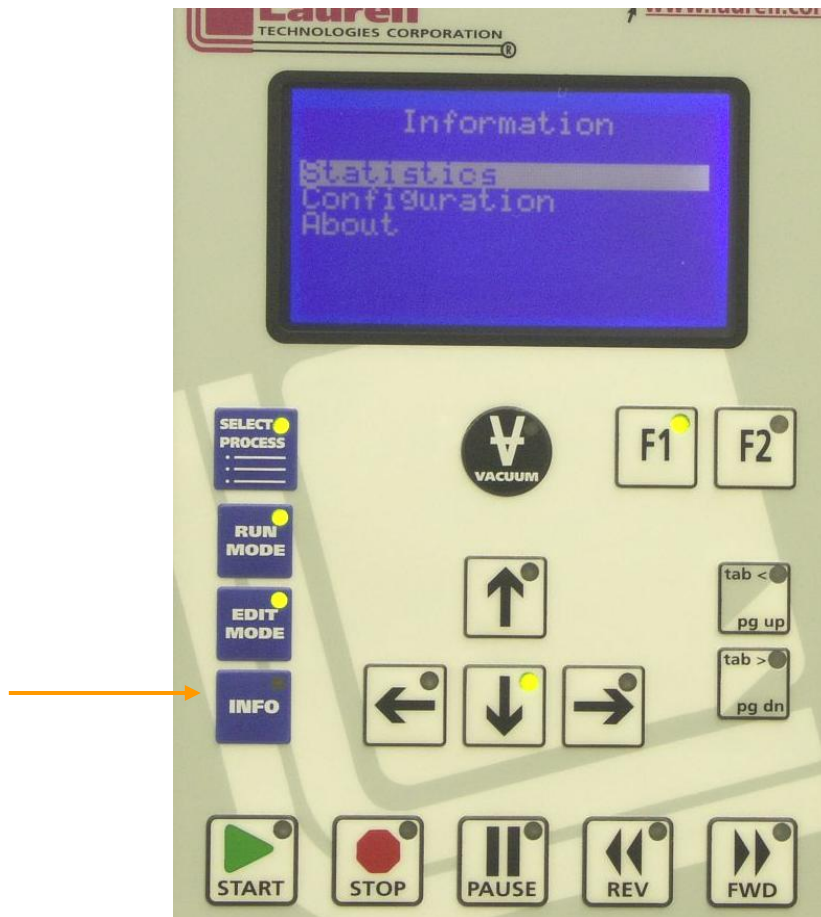

Figure 3-9
INFO MODE SCREEN

These menus are for informational purposes only. All system configurations are done through Spin 3000.

5 – NAVIGATION KEYS - ←(Left) & →(Right) and ↑(Up) & ↓(Down) – these directional keys have multiple functions within each menu. The “Up Arrow (↑)” and “Down Arrow (↓)” keys can be used to scroll up or down a list of items such as the program list in the “Select Process” menu. They can be used in the “Run” or “Edit” mode to move from line to line within a menu. The ↑(Up) & ↓(Down) keys are used

to change values when editing a field within a program. The ←(Left) & →(Right) keys are used to scroll left or right when there is additional information off to the left or right of the display. They are used in the edit mode to move within a field. These keys are active when the green LED is illuminated.

6 – TAB< / PG UP – this is a dual function key. The “Tab<” key is used to move from field to field in the “Edit Mode”. When pressed this key changes a highlighted field to an *editable* blinking field. The “Pg Up” key is used to scroll up a list of items when there are 4 lines or more of information. This key is active when the green LED is illuminated.

7 – TAB> / PG DN – this is a dual function key. The “Tab>” key is used to move from field to field in the “Edit Mode”. When pressed this key changes a highlighted field to an *editable* blinking field. The “Pg Dn” key is used to scroll down a list of items when there are 4 lines or more of information. This key is active when the green LED is illuminated.

8 - VACUUM - this key toggles the vacuum valve on and off. This key is interlocked such that the vacuum cannot be turned off while a program is running or the chuck is in motion. The value is displayed in inches of Hg when the vacuum valve is turned on. The normal requirement to operate safely is ≥ 15 ” of Hg. This requirement can be modified in Spin 3000. The vacuum requirement of “vacuum required” or “vacuum not required” is programmable within a program. This key is active when the green LED is illuminated.

9 - F1 - this key is used to enter a submenu when available. Submenus can be accessed in the “Run” and “Edit Mode” when the valve or sensor line is highlighted. This key is active when the green LED is illuminated.

10 – F2 - this key is used to exit the submenu. When in a submenu pressing the F2 key will exit the user back to the “Run”, “Edit” or “Info” mode. This key is active when the green LED is illuminated.

11 - START - this key is used to initiate a programmed sequence. While a program is running the mode display will indicate “***RUNNING***”. “***DONE***” indicate that a program has run and will persist until the lid is opened or another program selection is made. This key is disabled until the vacuum, seal purge, exhaust and lid interlocks are satisfied. This key is active when the green LED is illuminated.

12 - STOP – this key will “Stop” the current program from completing the process program. When running a program in “run” or “edit” mode, the stop key will, when pressed, stop the process from completing the step, the motor will stop spinning and any active valves will close. The step and time is retained and if start is pressed again, the processing will resume where the process stopped. This key is active when the green LED is illuminated.

13 - PAUSE – this key will “Pause” the current program from completing the process program. When running a program in the run mode, the “pause” key will, when pressed, pause the process program time from proceeding. The motor will continue to spin and any active valve will remain on but the remaining time is ignored. The step and time is retained and if “pause” is pressed again, the processing will resume. This key is active when the green LED is illuminated.

14 - REV – Reverse back to the previous step in a program. This key is active in the “edit mode” to help while programming. Each time the key is pressed the user will go back to the previous step within a program. This function allows the wrapping of the first step to the last within a program. This function can be enabled to operate in the “run mode” by modifying the configuration in Spin 3000. This function in the “run mode” is disabled at the factory. This key is active when the green LED is illuminated.

15 - FWD – Advance forward to the next step in a program. This key is active in the “edit mode” to help while programming. Each time the key is pressed the user will go to the next step within a program. This function allows the wrapping of the last step to the first within a program. This function can be enabled to operate in the “run mode” by modifying the configuration in Spin 3000. This function in the run mode is disabled at the factory. This key is active when the green LED is illuminated.

3.4 - THE LCD DISPLAY

3.4.1 “SELECT PROCESS” SCREENS

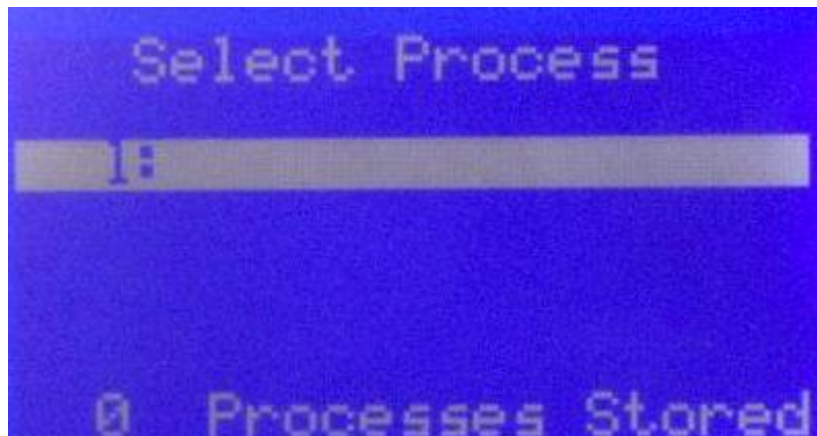

Figure 3-10A
SELECT PROCEES SCREEN

The “Select Process” screen is the default screen when the system is powered up. Figure 3-10A shows the “Select Process” screen when there are no resident programs stored in the 650 controller. Pressing the “Edit Mode” key when an empty line is highlighted, see figure 3-10B creates programs. Each line displays a ten-character program name followed by the number of program steps, in parentheses.

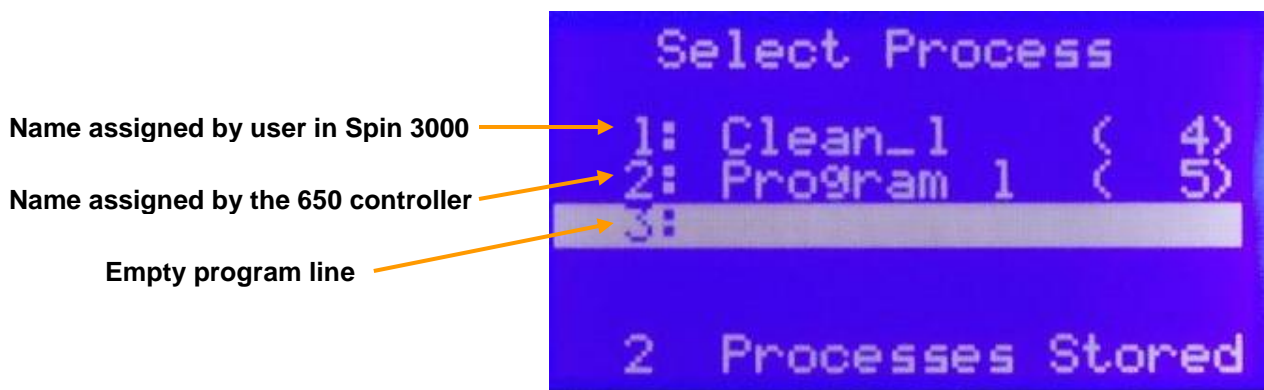

Figure 3-10B

The user selects the desired program by using the “Up Arrow (↑)” and “Down Arrow (↓)” keys to scroll through the list one line at a time. The “Page Up” and “Page Down” keys will scroll through the program list four lines at a time. The highlighted line is the currently selected program.

To creating a program in the 650 controller, highlight the last empty line, see line 3 of figure 3-10B, and press the “Edit Mode” key. Automatically a program name is assigned such as “Program 1” or “Program 2”. Line 2 of figure 3-10B is an example of a program name assign in the 650 controller. When creating programs using the Spin 3000 software any 10 character name can be assigned. Line 1 of figure 3-10B is an example of a named program created in Spin 3000.

To edit a program, use the “Up Arrow (↑)” or “Down Arrow (↓)” keys to select a program and then press the “Edit Mode” key.

The “Start” key is active in this mode. By pressing the start key the selected program will enter the run mode automatically and begin processing immediately.

Similarly, pressing the “Run Mode” key enables the user to enter the run mode screen for this program.

The last line of the display shows the total number of resident programs within the 650 controller.

3.4.2 “RUN MODE” SCREENS

Press the “Run Mode” key to enter a selected program into the “run mode”. Figure 3-11 shows the “Run” screen.

Displayed fields are the operation mode/program name, step-of-steps, vacuum status, set point time, agitation rate, actual wafer spin rotation direction and substrate rpm, set point wafer spin rotation direction and substrate rpm and spin rotation direction, valve, sensor and type status and processor status/error messages for each step of a program.

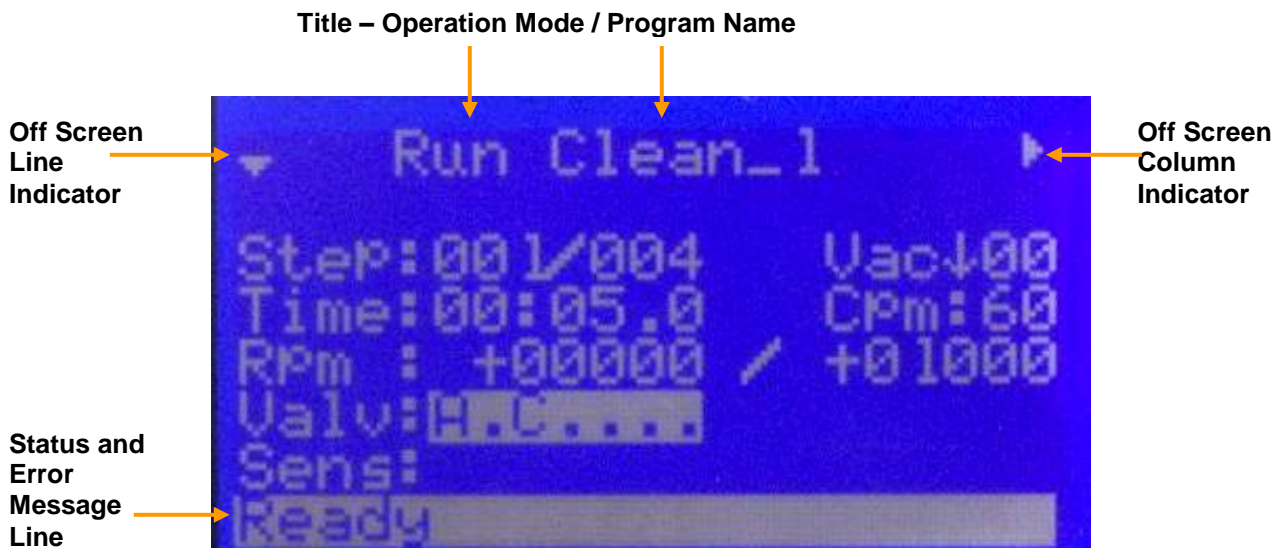

Figure 3-11

The off-screen line indicator, see figure 3-11, appear at the upper left-most side of the display and uses up or down arrows, or both, to indicate additional menu lines either above or below the portion of the menu currently being viewed.

The off-screen column indicator appear at the upper right-most side of the display and uses left or right arrows, or both, to indicate additional menu text columns either to-the-left or to-the-right of the portion of the menu currently being viewed. A user scrolls off-screen portions of a menu into view by using the navigation keys.

3.4.2.1 “RUN MODE” – DISPLAYED FIELDS – see figure 3-11

- **Title** – Operation Mode / Program Name – shows the operation mode that the user is in and the program name
- **Step** – Step-of-steps; the 1st field is the current step and the 2nd field is the total number of steps in the program. While running a program the “FWD” or “REV” keys, if enabled in Spin 3000, can move from step-to-step, by pressing the FWD or REV keys. This feature can be enabled or disabled in Spin 3000. If disabled, this function will not be available in the run mode.
- **Vac** - The ↑ shows that the vacuum key was pressed and the ↓ shows that the vacuum key was not pressed. If a program requires vacuum, set in the edit mode, the process will not run until vacuum is present and in the correct amount. The amount of vacuum present is displayed next to the arrow. The factory set point is 15” of Hg.
- **Temp** – Use the “Right Arrow (→)” key to scroll to the “Temp” field. This field shows the actual motor temperature. The factory set point is 55°C. The 650M or 23 models do not have temperature readout.

- **Loop** - Use the “Right Arrow (→)” key to scroll to the “Loop” fields. The 1st field shows actual number of loops completed and the 2nd field shows number of loops programmed. The next line “GoTo” shows the program line of where to loop back to.
- **Time** - Following the “Time” label are the step duration fields which are in the form of mm:ss.t where mm is minutes, ss is seconds, and t is tenths of seconds. A step must have at least one second duration. The minimum time possible is 1 second. When running, the time will count down to 00:00.00 before moving to the next step.
- **Cpm (650H/HPD2 motor only)** - Following the “Cpm” (cycles per minute) label is a field indicating the agitation rate for the step. Selections are 0, 15, 30, and 60 cpm. When selected, the step duration and speed/acceleration can be set but must be achievable. The spin processor’s controller cannot determine the inertial load so it will permit unachievable speed and acceleration rates to be entered...no control fault will occur (just not attain the requested rates). The factory can provide guidelines if requested on all Laurell manufactured chucks with defined substrate load.
- **Rpm** - Following the “Rpm” label is the desired target speed in revolutions per minute. The left field shows the actual rpm while the right field shows the set point value. Negative speeds may be entered which causes the motor to rotate in the opposite direction (**HPD-2 only**).
- **Valv** - Following the “Valv” label is a field indicating desired valve positions. From left-to-right the valves are labeled “A, B, C...” up to 16 possible valves. If a valve is enabled a letter appears. A dot “.” indicates the valve is off. A dash “-” indicates the valve is off and is mutually exclusive (MXL) with some subset of valves (also indicated by “-” if off). Valves that are mutually exclusive to each other cannot be turned on simultaneously. Only one valve of a MXL group can be on at any one time. If another valve in that group is activated, the other valve will automatically turn off. This is a safety feature to prevent incompatible chemicals from dispensing at the same time. The MXL feature can only be assign in Spin 3000. This field has a sub-menu where the valve names are displayed and whether or not they are mutually exclusive. Press the F1 key to enter the valve sub-menu, see figure 3-11B. Use the navigation or the “pg up” or “pg dn” keys to scroll through the list of valves. If valves are designated as MXL, the submenu will show “MXL” beside the associated valves, see figure 3-11B. Press the F2 key to exit a submenu. In the run mode the user is able to scroll down to the “Valv”, “Sens” or “Type” line. Figure 3.11A shows the highlighted valves or “Valv” line. When the “Valv” or “Sens” line is highlighted the F1 key is activated. Figure 3-11A shows that there are 7 valves, “A” and “C” are enabled, “B” and “D” are MXL and not enabled, valves “E”, “F” and “G” are off in step 1 of Clean_1 program.

There are no sensors. Figure 3-11B & C are an example of a submenu of valves.

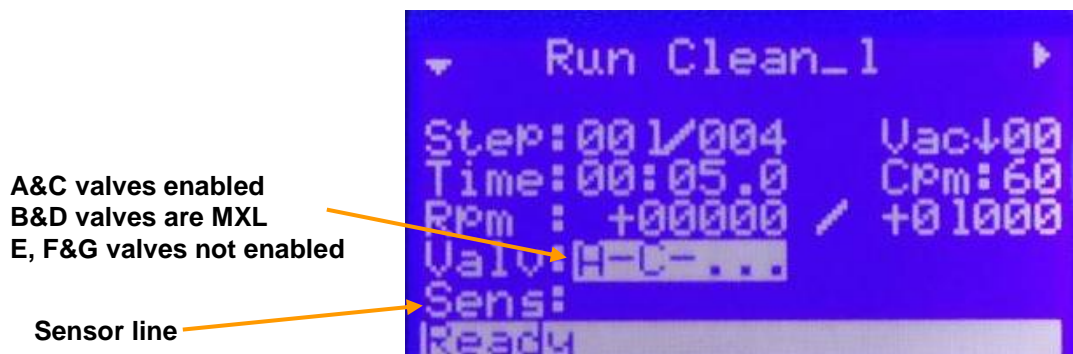

Figure 3-11A

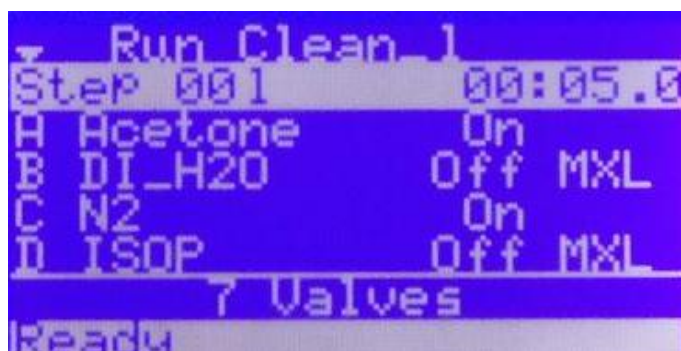

Figure 3-11B



Figure 3-11C

Sens - Following the “Sens” label is a field indicating enabled sensors. From left-to-right the sensors are labeled “A, B, C...” up to 16 possible sensors. If enabled, a letter appears. A dot “.” indicates the sensor is inactive. This field has a submenu where the sensor names are displayed and what will happen if they are triggered. Pressing the “F1” key enters the sub-menu. Use the navigation or the “pg up” or “pg dn” keys to scroll through the list of sensors. For example, there are 4 possible sensors with “A” and “B” active for step 1, see figure 3-12. The sensor F1 submenu is figure 3-12A. Through Spin 3000 the first 3 valves were assigned names. “Chem Low” (chemical low) name to sensor “A”, “Waste High” to sensor “B”, “MOhm” (resistively) to sensor “C” and sensor “D” was not given a name.

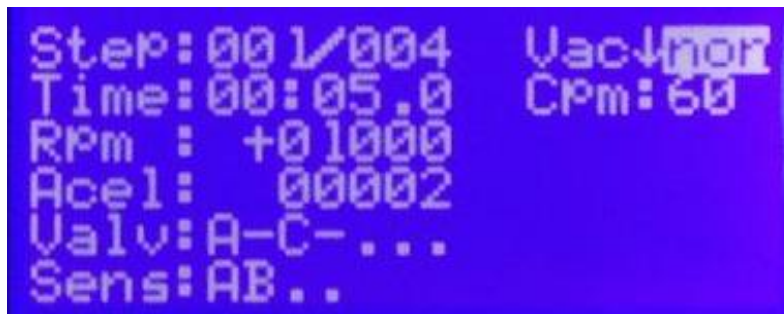

Figure 3-12



Figure 3-12A



Figure 3-12B

The sensor “ON” state can be modified according to the input device design. Spin 3000 can be configured according to the triggering device which can be “normally on” or normally off”. See figure 3-12A, sensors A, B and C are set to off and sensor D is set to on. The resultant action associated with each sensor is shown in figure 3-12B. Sensor A will provide a “Warn” or warning message if sensor A is triggered ON. Sensor B will “Abort” the processor and provide an abort message if sensor B is triggered ON. Sensors C will “Next” or go to the next step in the program if sensor C is triggered ON. Sensor D will “Start” the processor if sensor D is triggered OFF. Press the F2 key to exit a submenu.

- **Type** – Following the “Type” label is a field indicating sensor action. This line is directly linked to the “Sens” line. Different sensor actions can be assigned to the operation of a sensor. For example, a sensor may be assigned to “abort the process” if a certain condition is sensed. The “Type” field will show, in abbreviated form, the action assigned to the sensor. The sensor action can only be assigned in Spin 3000. Below is the list of possible sensor actions and its’ abbreviation.
 - “Abort” = A
 - “Next Step” = N
 - “Start” = S
 - “Warning” = W



Figure 3-12C

The Type field in figure 3-12C has the characters “WANS”. The “W” indicates that a “Warning” command is associated with sensor A. The “A” indicates that an “Abort” command is associated with sensor B. The “N” indicates that a “Next Line” command is associated with sensor C. The “S” indicates that a “Start” command is associated with sensor D.

- **Message Line** – The bottom field of the display will always show the status of the processor, such as “**READY**”, “**RUNNING**” or “**STOPPING**”. If the processor senses an error condition, that error message will be displayed in this field. The display in figure 3-12D tells the user the system, is “**READY**” to run. Status and error messages are displayed only in the “Run Mode”.

3.4.2.2 “RUN MODE” – OPERATION

As can be seen in figure 3-12D, the message line shows the processor is “**READY**” and the “Start” key is active. Pressing the “Start key” will initiate the running of program “Clean_1”.



Figure 3-12D

Figure 3-13 shows the processor running program “Clean_1”. The status line tells the user the system is “**RUNNING**”. Pressing the active “Stop” or “Pause” key will stop or pause processing. Pressing the “Stop” key will cause the processor to stop. The “Start” key becomes active and by pressing the “Start” key again the processor will begin processing from the stop point. If “Stop” is pressed and the user leaves the “Run Mode” the program will revert back to the beginning of the program. Pressing the “Pause” key will cause the processor to pause at this point. The substrate will continue to spin and valves will continue to operate but the remaining time will be ignored. Pressing the “Start” key will resume processing at this point. The “Up Arrow (↑)” and “Down Arrow (↓)” keys are active in the “run mode”. Highlighting the valve or sensor line enables the F1 key to become active. Pressing the “Right Arrow (→)” key scrolls the display to the right. The motor temperature display is located off the screen to the right. While running the “Select Process”, “Edit” and “Info” keys are disabled (not active).

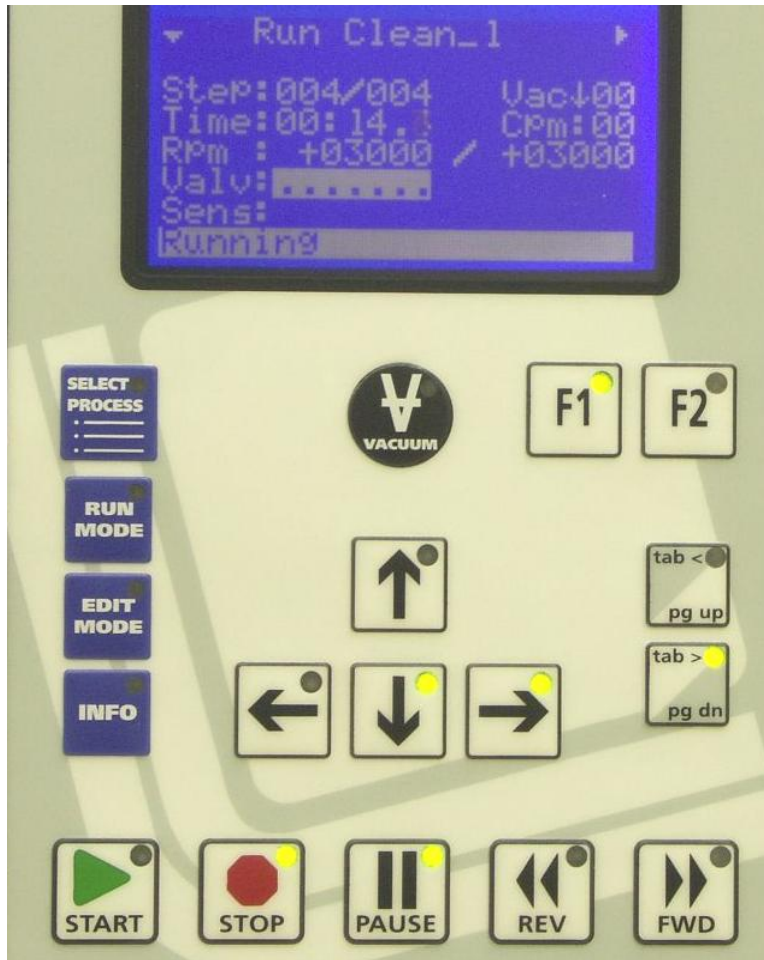

Figure 3-13

Any system fault or error message will be displayed on the last field of the LCD panel. Figure 3-14 shows an example of a low exhaust error message.

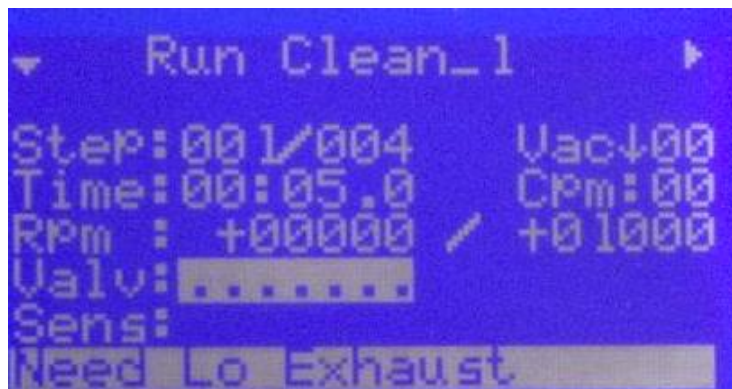

Figure 3-14

3.4.3 “EDIT MODE” SCREENS

Press the “Edit Mode” key to enter a selected program into the “edit mode”. Figure 3-15 shows the Edit screen.

Displayed fields are the operation mode/program name, step-of-steps, vacuum status, time, agitation rate, spin rotation direction and wafer rpm, acceleration rate, valve, and sensor status and off screen the sensor type line.

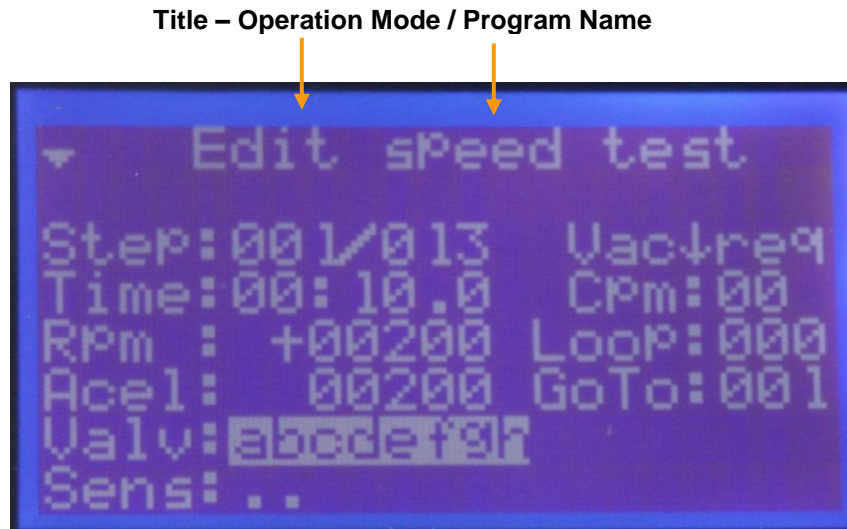

Figure 3-15

3.4.3.1 EDIT MODE – DISPLAYED FIELDS – see figure 3-15

- **Title** – Operation Mode / Program Name – shows the operational mode that the user is in and the program name
- **Step** – shows steps-of-steps; the 1st field is the current step and the 2nd field is the total number of steps in the program. When editing a program the “FWD” or “REV” keys, can move from step-to-step, by pressing the “FWD” or “REV” keys. This feature in the “edit mode” is always enabled.
- **Vac** – this field sets the vacuum requirement i.e. if vacuum is required or not required for a program. If vacuum is required the field will show “req”; if vacuum is not required the field will show “non”. This setting is a global setting for the entire program. The ↑ shows that the vacuum key was pressed and the ↓ shows that the vacuum key was not pressed. If a program requires vacuum the process will not run until vacuum is present and in the correct amount. The amount of vacuum present is displayed next to the arrow. The factory set point is 15” of Hg.
- **Time** - Following the “Time” label are the step duration fields which are in the form of mm:ss.t where mm is minutes, ss is seconds, and t is tenths of seconds. A step must have at least one second duration. The

minimum time possible is 1 second. When running the time will count down to 00:00.00 before moving to the next step.

- **Cpm (650H/HPD2 motor only)** - Following the “Cpm” (cycles per minute) label is a field indicating the agitation rate for the step. Selections are 0, 15, 30, and 60 cpm. When selected, the step duration and speed/acceleration can be set but must be achievable. The spin processor’s controller cannot determine the inertial load so will it permit unachievable speed and acceleration rates to be entered...no control fault will occur (just not attain the requested rates). The factory can provide guidelines if requested on all Laurell manufactured chucks with defined substrate load.
- **Loop** – Enter the number of loops to be performed. The “GoTo” line specifies where in the program to loop back to, to begin another loop cycle.
- **Rpm** - Following the “Rpm” label is the desired target speed in revolutions per minute. The field shows the set point value. (HPD2 only - Negative speeds may be entered which causes the motor to rotate in the opposite direction).
- **Acel – (HPD2 Motor Only)** Following the “Acel” label is the motor acceleration rate in rpm/second. The maximum acceleration rate is 30,000 rpm/s. This rate is also used as a deceleration rate. To slow down quickly enter a large value, conversely to slow down slowly enter a small value.
CAUTION: When using a mechanical chuck always use low acceleration rates to prevent the possibility of throwing a substrate from the chuck!
- **Acel – (650M - Standard Motor Drive Only)** - Following the “Acel” label is the motor acceleration rate in rpm/second. For the standard motor drive the maximum acceleration rate is very dependent on the mass of the chuck and substrate. A proper acceleration value will prevent spin speed overshoot when spinning a substrate.

Calculate the acceleration rate value by taking the spin speed difference between steps and using that difference for the acceleration rate for the current step. For example:

<u>Step</u>	<u>Time</u>	<u>RPM</u>	<u>Acel</u>
1	5.0	500	500
2	5.0	1500	1000

The speed difference between step 1 and 2 is 1000rpm. Use this difference as the acceleration rate in step 2. Continue this calculation throughout the program. This calculation is a guide for finding the proper maximum acceleration rate.

- **Valv** - Following the “Valv” label is a field indicating desired valve condition. A lower case letter, “a” for example, indicates the valve is off. From left-to-right the valves are labeled “a, b, c...” up to 16 possible valves. If a valve is enabled an upper case letter, “A” for example, appears. This field has a sub-menu where the valve names are displayed and whether or not they are mutually exclusive. A dash “-” indicates the valve is off and is mutually exclusive (MXL) with some subset of the valves (also indicated by “-” if off). Valves that are mutually exclusive to each other means that only one valve of a MXL group can be turned on. If another valve in that group is activated, the previous valve will automatically turn off. This is a safety feature to prevent incompatible chemicals from dispensing at the same time. The MXL feature can only be assign in Spin 3000. Pressing the “F1” key enters the valve sub-menu. Use the navigation or the “pg up” or “pg dn” keys to scroll through the list of valves and sensors. If valves are designated as MXL, the submenu will show “MXL” beside the associated valves. Press the F2 key to exit a submenu. **(Note: in the Run mode only upper case letters or dot “.” will appear.)**
- **Sens** - Following the “Sens” label is a field indicating enabled sensors. A dot “.” Indicates the sensor is inactive. From left-to-right the sensors are labeled “A, B, C...” up to 16 possible Sensors. If enabled, a letter appears. This field has a sub-menu where the sensor names are displayed and what will happen if they are triggered. Pressing the “F1” key enters the sub-menu. Use the navigation or the “pg up” or “pg dn” keys to scroll through the list of valves and sensors. Press the F2 key to exit a submenu.
- **Type** – Following the “Type” label is a field indicating sensors action. This line is directly linked to the “Sens” line. Different sensor actions states can be assigned to the operation of a sensor. For example, a sensor may be assigned to “abort the process” if a certain condition is sensed. The “Type” field will show, in abbreviated form, the action assign to the sensor. The assigning of sensor action can only be assigned in Spin 3000. Below is the list of possible sensor actions and its’ abbreviation.
 - “Abort” = A
 - “Next Step” = N
 - “Start” = S
 - “Warning” = W

3.4.3.2 “EDIT MODE” – OPERATION

As can be seen in figure 3-16, the 650 controller is in the “Edit Mode”. The title shows “Edit” as the operation mode. The “Start” key is active. Pressing the “Start” key will initiate running of program “speed test”. A program will run in the “edit mode” but the time is ignored. The processor will run indefinitely until the “stop” key is pressed. To move from step-to-step within a program while running, press the “FWD” or the “REV” key. All fields are changeable while running.

Revision Date: 12/7/2011



Figure 3-16

Each field is highlighted when it is selected. Figure 3-16 shows the “Valv” field highlighted. Use the “Up Arrow (↑)” and “Down Arrow (↓)” navigational keys to move from line to line. The “Tab<” and the “Tab>” key when pressed enables the highlighted field to be editable. When a “Tab<” or “Tab>” key is pressed the highlighted field will blink, this is an indicator that the field is now changeable. When a “Tab<” or “Tab>” key is pressed the blinking cursor will move from field to field within a program. The “Up Arrow (↑)” and “Down Arrow (↓)” keys will change the value or state of an *editable* field. The ←(Left) & →(Right) keys are used to move within a field with many digits such as speed and acceleration. When the valve or sensor field is highlighted the F1 key is becomes active to allow access to their respective submenus.

Figure 3-17 shows the “Valv” field highlighted. Valve A and B of step 1 are activated within the program. There are 8 possible valves. All the other valves are off in step 1 as indicated by “lower case” letters.

When the F1 key is pressed the user will enter the valve submenu. See figure 3-18.



Figure 3-17

Figure 3-18 shows 4 of the 7 possible valves. The last 3 valves are on the next page as indicated by the “off screen line indicator” in the upper left hand corner of the display. Valve A, “Acetone” is set to “ON”.



Figure 3-18

Figure 3-19 shows the last 3 valves. The first field below the title shows the step number. A specific name for a valve can be assign in Spin 3000, such as “Acetone”. The default name is “valve 1”, “valve 2” etc...



Figure 3-19

3.4.4 “INFO MODE” SCREENS

Press the “Info Mode” key to access information on the spin processors’ “Statistics”, “Configuration” and “About”. Figure 3-20 shows the “Info Mode” screen.

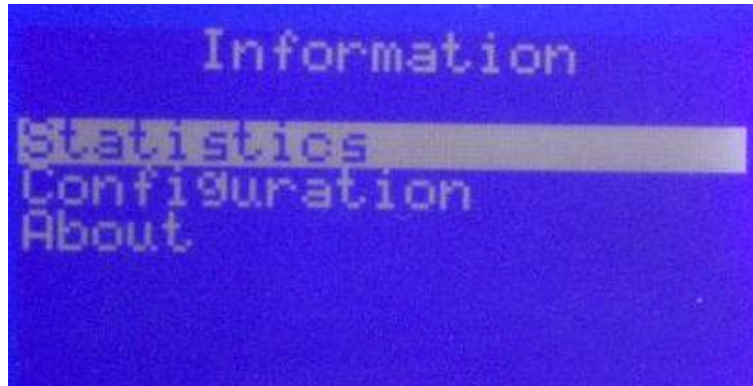

Figure 3-20

Figure 3-21A shows the 1st screen of the Statistic page and figure 3-21B shows the 2nd page.

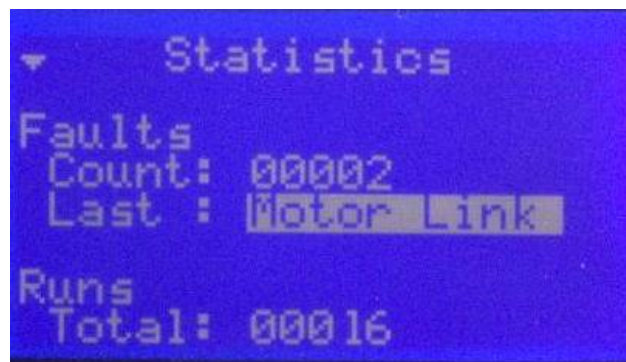

Figure 3-21A



Figure 3-21B

3.4.4.1 “INFO MODE” - STATISTICS - DISPLAYED FIELDS – see figures 3-21A & 3-21B

- **Faults / Counts** - The “count” line shows the total number of faults or errors which occurred in the spin process.

- **Faults / Last** - This is an active field. Press the F1 key to access the complete list of faults or errors that have occurred. The listed error messages are organized from newest to oldest and are date and time stamped. The list will hold 255 lines of error messages. Once the list is full the oldest error message will be overwritten.
- **Runs / Total** – This field shows the spin processor total number of runs.
- **Runs / Time** – This field shows the total usage time of the spin processor.
- **Motor Temperature / Current** – This field shows the current motor temperature in real time.
- **Motor Temperature / Highest** - This field shows the highest motor temperature the motor ever attained.

3.4.4.2 “INFO MODE” - CONFIGURATION - DISPLAYED FIELDS – see figures 3-22A-3-22E

- The configurations pages below reflect the set up parameters as assigned in Spin 3000.
- Some of these parameters are factory settings, which cannot be changed. There are other parameters, which are user defined.
- These pages are for information only. These parameters cannot be modified using the 650 controller

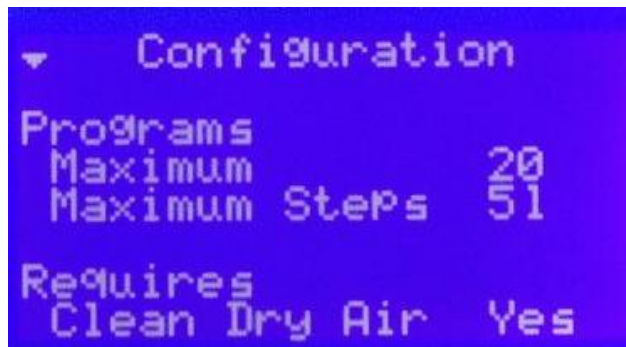

Figure 3-22A

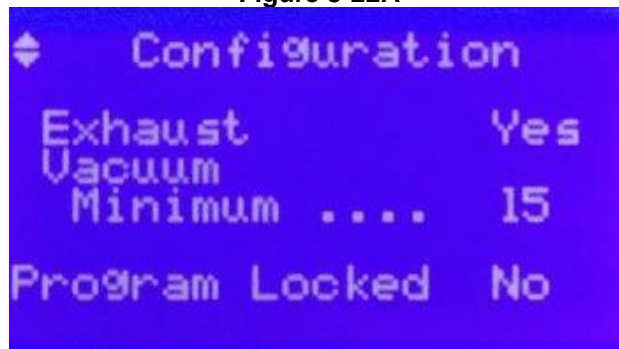

Figure 3-22B

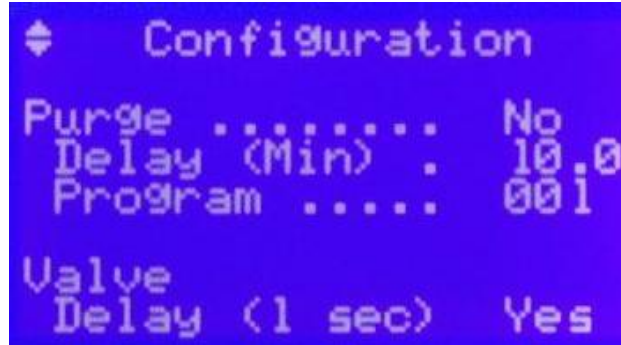

Figure 3-22C

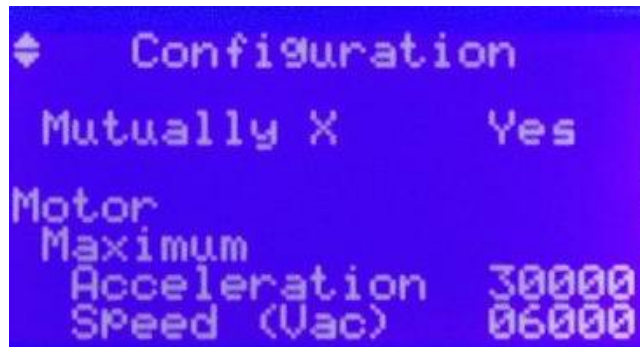

Figure 3-22D

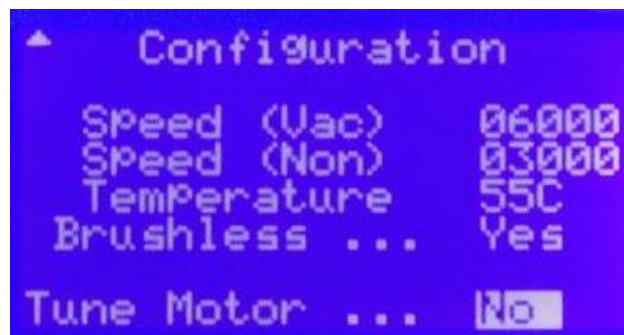

Figure 3-22E

- **Programs / Maximum** – This field shows the maximum number of programs (20) allowed in the 650 controller. This can be modified by the user.
- **Programs / Maximum Steps** – This field shows the maximum number of steps (51) allowed in a program. The number of steps is calculated on the number of programs.
- **Requires / Clean Dry Air** – “YES” in this field enables the requirement of having N2 or CDA pressure present to actuate pilot air valves, pneumatic vacuum valve and to provide seal purge flow. Less than 60 psi will cause a “need CDA” error. This is a factory setting.

- **Requires / Exhaust** – “YES” in this field enables the interface between the exhaust differential pressure gauge and the 650 controller. Any exhaust level above or below the set points enter into the exhaust controller will cause an “exhaust” error. This is a factory setting.
- **Requires / Vacuum – Minimum** – “15” in this field shows the minimum amount of vacuum required before a vacuum chuck operation can be started. A vacuum level < 15” of Hg will cause a “vacuum” error. User defined.
- **Program Locked** – “NO” in this field enables all users to create, in Spin 3000 and the 650, programs and enter programs into the 650 controller. “YES” in this field prevents all programming in Spin 3000 and the 650 controller. Downloads from Spin 3000 are prevented. User defined.
- **Purge** – This function is designed to run a “purge” program at a scheduled interval. “NO” in this field disables the use of a purge program. “YES” in the field enables a purge program to run. When “YES” the purge command operates in conjunction with the “delay and “program” parameters. User defined.
- **Purge / Delay (Min)** – When purge is set to “YES” enter a time, in minutes, in this field to set the time interval for the purge program. At this interval the specified program will run. User defined.
- **Purge / Program** – Enter the program number of the purge program. This program will run at the time interval set in “delay”. User defined.
- **Valve / Delay (1 sec)** – “Yes” in this field sets a 1 second delay between the closing of a valve and the opening of the next valve. This is a factory setting.
- **Mutually X-MXL** – This field when set to “YES” indicates that there are designated valves defined in Spin 3000 that are mutually exclusive to each other. Only 1 valve at a time will be allowed to dispense from this group. This is a factory setting.
- **Motor / Maximum / Acceleration** – This field indicates the maximum acceleration speed that the motor can achieve. The factory has limited the maximum acceleration value that can be entered. The user can modify this value.
Caution: It is recommended not to use extremely high acceleration rates with mechanical chucks.
- **Motor / Maximum / Speed (Vac)** - This field indicates the maximum speed that the motor can achieve when vacuum is required. This is a factory setting.

- **Motor / Maximum / Speed (Non)** - This field indicates the maximum speed that the motor can achieve when vacuum is not required. This is a factory setting.
- **Temperature** – This field shows the maximum temperature the motor can reach before a fault condition is detected. This is a factory setting. The 650M model does not have temperature readout.
- **Brushless** – This field shows the type of motor installed in the spin processor. This is a factory setting.
- **Tune Motor** – This field is used when the brushless motor needs tuning/calibration. This is an active field. Only factory trained personnel perform tuning/calibration.

3.4.4.3 “INFO MODE” - ABOUT - DISPLAYED FIELDS – see figures 3-23A

- To access the entire screen use the Right arrow → key to scroll to the right.
- **Model** – This field shows the spin processor model.
- **S/N** – This field shows the spin processor serial number.
- **Firmware** – This field shows the firmware revision number.
- **Controller** - This field shows the revision level of motor controller card.



Figure 3-23A

3.5 – PROGRAMMING THE 650 CONTROLLER

1. Turn on the spin processor. The 650 will initialize and default to the “Select Process” screen.
2. If editing an existing program, highlight the desired program. If creating a new program highlight the empty line. Press the “Edit Mode” key. If this is a new program a program name will be assigned. The program name will appear on the title line.
3. Use the navigation keys to move from line-to-line or the “Tab<” or “Tab>” key to move to field-to-field. The “Tab” key enables the field to be editable. Make changes to the field by using the ↑(UP) or ↓(DOWN) arrow keys.
4. Add or delete steps by highlighting the “steps” field with the “Tab” key and increase or decrease the number.

5. Move from step-to-step by using the “FWD” or “REV” key.
6. To change valve condition highlight the valve field, press the F1 key and edit the submenu using the “Tab” keys and the ↑(UP) or ↓(DOWN) arrow keys. Exit the submenu by pressing the F2 key. Valve configuration is done at the factory at time of order.
7. To change sensor action highlight the sensor field, press the F1 key and edit the submenu using the “Tab” keys and the. ↑(UP) or ↓(DOWN) arrow keys. . Exit the submenu by pressing the F2 key. Sensor configuration is done at the factory at time of order.
8. When finished press the “Run Mode” key to run the program.

➤ **Example of an coat program.** This is for example only; the user must find the best parameters for their process.

PROGRAMMING EXAMPLE

Program: Coat_1

Valve Identification

A	E
B	F
C	G
D	H

Step	Time		Speed 0-6,000	Valves X=ON								Accel	Comment
	99 Min	59.9 Sec		A	B	C	D	E	F	G	H		
1		5	500	A	B	C	D	E	F	G	H	500	This step is to get the chuck rotating at step 2 spin speed.
2		1.5	500	X	B	C	D	E	F	G	H	500	Spin speed same as step 1. Dispense for 1.5 sec.
3		1.5	2000	A	B	C	D	E	F	G	H	1500	Spin off excess material
4	1	30	4000	A	B	C	D	E	F	G	H	2000	Dry film
5				1	2	3	4	5	6	7	8		

3.6 - RUNNING THE 650 CONTROLLER

1. Select the program to be run using the “Select Process” key. Press the “Run Mode” key. The program name will appear on the Title line
2. Open the lid; place and align a substrate on the chuck. Press the “Vacuum” key to activate the vacuum valve if vacuum is required. Sufficient vacuum to hold the

substrate is required to start the motor. If using a non-vacuum chuck the vacuum requirement can be disabled in the edit mode.

3. Close lid.
4. Press “Start” key to start a program. The program will not start until the vacuum hold down requirement is met (vacuum chucks only), the seal purge requirement is satisfied, exhaust flow is correct if needed and the lid is closed. The program will stop automatically if the lid is opened, or the N₂ motor seal purge is not satisfied (<60 PSI), or exhaust drops or increases beyond the set point or the vacuum requirement for hold down is not maintained. The remaining process time will be maintained.
5. “Done” will be displayed when the process is completed and the lid has not yet been opened for wafer removal. Restarting the same sequence on the same wafer is not allowed until the lid is opened or the “Edit” key is pressed then the “Run” key.

3.7 - REMOVING/CHANGING CHUCKS

3.7.1 “SCREW ON” CHUCK

- Hold the two horizontal arms on the column below the base of the chuck. Turn the chuck counter-clockwise to remove (see fig. 3-12A), and clockwise to install, making sure the chuck is snug (see fig.3-12B).
- ***DO NOT OVER TIGHTEN (especially Teflon)!***

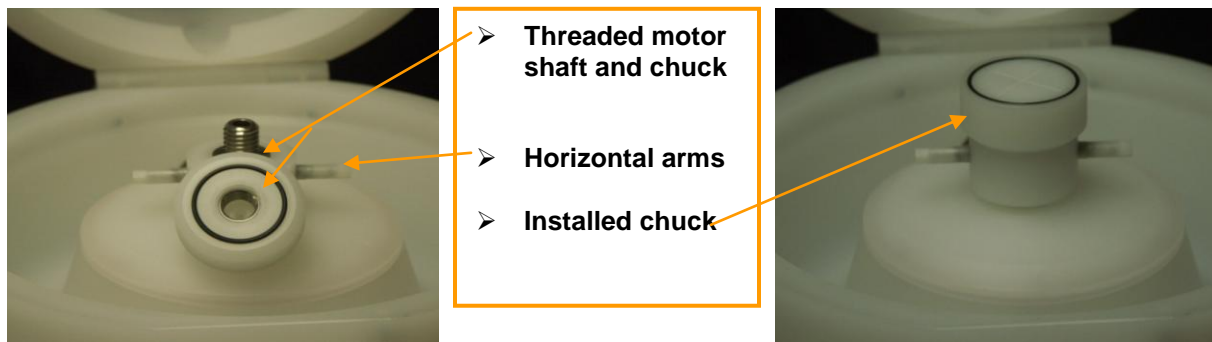

Figure 3-12A

Figure 3-12B

3.7.2 “PRESS-ON” OR “SCREW DOWN” CHUCK

Laurell Technologies also uses a press-on or screw down chuck with our standard drive motors. These two styles of chucks are interchangeable – the press-on is a chuck which presses onto the motor shaft adapter and the screw down chuck screws onto the motor shaft adapter. See photos below to identify which chuck design you have.

1. **Press-on Chuck:** To remove the chuck, gently lift up on the edges; lift one side then the other. To install a chuck (see figure 3-13), align the 2 locating pins on the motor shaft adapter with the corresponding holes in the chuck; place the

bottom of the chuck over the motor shaft adapter and press down. Be sure to firmly push the chuck into place.



Figure 3-13
INSTALLING PRESS-ON CHUCK

- 2. Screw Down Chuck:** The first step in removing the screw down chuck is to remove the screw cover insert (see figure 3-14a). Once the insert is removed, you will notice 2 screw heads (fig. 3-14b). Use a 9/64" Allen wrench to remove both screws and gently pull the chuck upward until it is free of the motor shaft adapter (fig. 3-14c). Replacing the chuck is done by aligning the 2 locating pins on the motor shaft adapter with the corresponding holes in the chuck. Place the 2 screws into the chuck and firmly tighten the screws. **Do not force the chuck into position, or hit it with anything to seat it (STOP immediately and contact the factory for advice).**

NOTE: Laurell Technologies Corporation does not warranty any damage to the equipment caused by incorrectly installing a chuck or substrate.



Figure 3-14a



Figure 3-14b

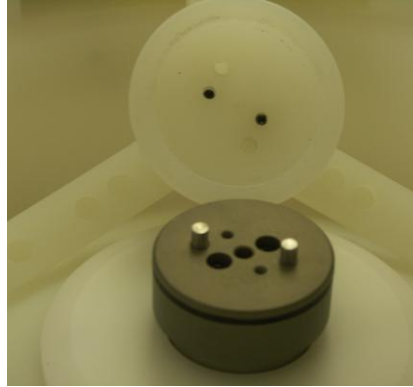

Figure 3-14c
REMOVING AND INSTALLING SCREW DOWN CHUCK

3.7.3 HIGH PERFORMANCE DRIVE (HPD2) MOTOR - PRESS-ON OR SCREW DOWN CHUCK

Laurell Technologies uses a press-on or screw down substrate chuck with our 300 mm processor models and with all High Performance Drive (HPD2) motors. These two styles of chucks are interchangeable – the press-on is a chuck which presses onto the motor shaft adapter and the screw down screws onto the motor shaft adapter. See figures 3-13 & 3-14.

3.8 – HIGH PERFORMANCE DRIVE MOTOR (HPD2)

The HPD2 brushless motor is standard on our 15 series models and is optional with our other spin processors. All models equipped with a HPD2 motor have an additional lid interlock which prevents the opening of the lid while the tool is in operation. All HPD2 motors have an insert or screw down chuck (see section 3.7.3).

3.8.1 PROGRAMMING THE HPD2

See section 3.4.3 Edit mode for information on how to edit.

- **ACCELERATION:** The HPD2 is capable of extremely fast acceleration rates up to 30,000 rpm/second. (Acceleration rates are greatly influenced by chuck load so individual cases may vary.) Acceleration is programmable from 2 to 30,000 rpm/sec.

CAUTION: When using a mechanical chuck always use low acceleration rates to prevent the possibility of throwing a substrate from the chuck!

- **SPIN SPEED:** The HPD2 spin speed is programmable with both positive and negative numbers. Positive numbers $>+00001$ will cause the motor to rotate counter clockwise and negative values <-00001 will cause clockwise rotation. Negative values can be entered by highlighting the + or – symbol in the edit mode and pressing the up or down arrow key. See figure 3-27

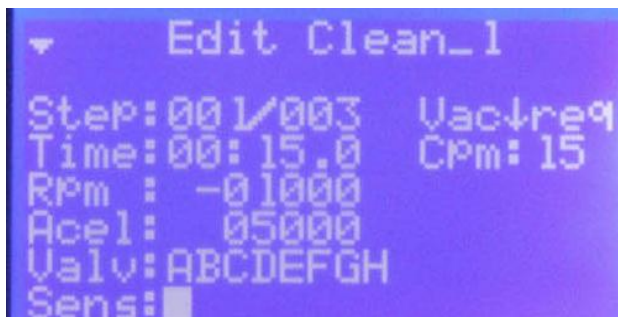

Figure 3-27
EXAMPLE OF NEGATIVE SPIN SPEED VALUE

➤ **PROCESSING TIP:** An agitation type program is possible when using both positive and negative spin speeds. The below example is meant to show how agitation programming is possible. Use the Cpm field to enter an agitation rate (15, 30 or 60 cpm) or the user can build their own program and rate.

EXAMPLE OF AN AGITATION PROGRAMMING

Step	Time		Speed 0-6,000	Valves X=ON								Accel	Comment
	99 Min	59.9 Sec		1	2	3	4	5	6	7	8		
1		00.5	100	1	2	3	4	5	6	7	8	1000	
2		00.5	-100	1	2	3	4	5	6	7	8	1000	
3		00.5	100	1	2	3	4	5	6	7	8	1000	
4		00.5	-100	1	2	3	4	5	6	7	8	1000	
5		00.5	100	1	2	3	4	5	6	7	8	1000	
6		00.5	-100	1	2	3	4	5	6	7	8	1000	
7		00.5	100	1	2	3	4	5	6	7	8	1000	
8		00.5	-100	1	2	3	4	5	6	7	8	1000	
9		00.5	100	1	2	3	4	5	6	7	8	1000	
10		00.5	-100	1	2	3	4	5	6	7	8	1000	

3.9 – FIRMWARE VERSION

The firmware version can be determined by pressing the “INFO” key then scroll down to the “About” field then press the “F1” key. Scroll to the right to see the full field.

3.10 – WAFER SIZE vs. SPIN SPEED

Vacuum Chucks

Maximum spin speed is dependent on substrate size, shape and weight in conjunction with chuck diameter (vacuum holding area) and weight. All substrates regardless of size or shape must be centered on the vacuum chuck. Off-centered substrates will cause vibration at high spin speeds and may cause a loss of vacuum.

Examples:

- A small fragment may be able to spin up to 12krpm if the proper sized fragment adapter is used.
- A 100mm – 150mm wafer should be limited to ~6krpm if a small chuck is used. The same size wafers may be spun faster if the chuck is the same diameter as the wafer.
- 200 – 300mm wafer depending on chuck size should be limited to 2.5 – 3.5krpm (if smaller than wafer).

Non-Vacuum Chucks

We recommend all non-vacuum chucks be limited to a maximum spin speed of 3krpm.

Revision Date: 12/7/2011

All information contained in this manual is the property of Laurell Technologies Corporation® and is NOT to be edited, reproduced or distributed without express written permission from a corporate officer.

SECTION 4 - MAINTENANCE

Generally there is very little maintenance required with our processors. Normal maintenance on the WS-650 Series spin processor is the cleaning the process bowl. It is recommended to clean the process bowl when processing is completed at the end of the day. Daily cleanup is a good practice and it prevents the excessive buildup of material over time. An appropriate solvent or cleaner should be used (wear all required personal protective equipment). It is recommended to leave the N₂ or CDA supply on so that the seal purge is constantly present and to leave the lid in the up position to allow drying of residual moisture. Any questions regarding the maintenance of your spin processor can be addressed at support@laurell.com

- **Care should be taken not to flood the process chamber during cleaning.**
- If unit is equipped with a vacuum chuck, **it is important not to allow chemicals or chemical cleaners to enter the vacuum path.**
- **NEVER flood or spray solvent such as acetone or any other type of cleaner directly onto the keypad surface. Doing so may cause keypad failure. Always wet a wipe or cloth with the solvent and gently wipe the keypad surface.**

NOTE!

The vacuum path is not designed for any pressure. Air pressure or any liquid forced or drawn into the vacuum chuck will very likely damage the vacuum sensor, seals, motor and electronics. This type of damage is not covered by our warranty



- **CLEANING** - Clean, rinse, then dry your spin processor after each use, taking care to prevent any chemicals from entering the vacuum path. A good practice is to cover the chuck during bowl cleaning. This can be done with a wafer with vacuum turned on or use a cover such as Petri dish. **ALSO DO NOT FLOOD**

Revision Date: 12/7/2011

THE AREA BETWEEN THE STATIONARY SEAL AND THE ROTATING SEAL. THIS CAN CAUSE MOTOR OR ELECTRONICS DAMAGE. See Fig. 4-1 below.

Do not fill up or overflow the process chamber or bowl – fluids must not be permitted to flow under the substrate. If the chuck face shows signs of chemical residue, remove and clean immediately. Cleaning the o-ring surface will improve the seal. Examine and adjust your process to prevent such occurrences. See section 4.1.3 Vacuum Chuck Wet Test

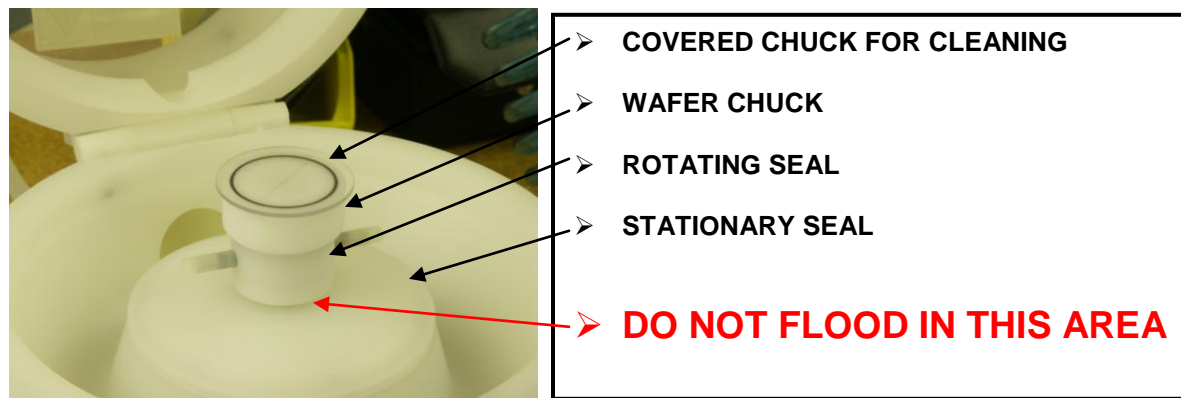

Figure 4-1

Do not at any time force fluids or pressuring gas in the center of the vacuum chuck. Cleaning the vacuum path in this manner is dangerous and can cause significant damage to your spin processor.

4.1 ERROR MESSAGES

The detection of abnormal operating conditions will cause the spin processor to shut down while in the process of running a program.

Depending on the spin processor's configuration these conditions are:

- Inability of spin processor motor to maintain the programmed speed parameters.
- Detection of vacuum loss to the wafer in systems equipped with a vacuum sensor and exhaust or N2 or CDA loss.

If these conditions occur, the display will indicate an error message in the "Run Mode" area of the display. The specific error codes are listed below.

CODE	DESCRIPTION	USER ACTION
<i>Ready</i>	Processor is ready to run	Press Start key
<i>Running</i>	Processor is running	Press Stop key to abort
<i>Paused</i>	Processor is in the paused state	Press the start key to resume running
<i>Done</i>	Processor completed a program	Open lid, remove substrate
<i>Lid Open</i>	Lid is open	Close lid to begin processing
<i>Need</i>	Insufficient vacuum to begin processing	Increase vacuum supply to

<i>Vacuum</i>		the processor / shut down processor
<i>Need CDA</i>	Purge Air pressure below setpoint. Will not start new process. Will shut down spin processor	Check "Seal Purge" hookup and pressure (SEC 3.2.3)
<i>Abort</i>	Processor aborted run	Check sensor action
<i>Unit Hot</i>	Motor temperature exceeded set point	Shut down spin processor
<i>Low Vacuum</i>	Vacuum below required minimum detected	Check vacuum source
<i>Lost CDA</i>	Purge Air pressure below setpoint. Will not start new process. Will shut down spin processor	Check "Seal Purge" hookup and pressure (SEC 3.2.3)
<i>Sensor Warning</i>	Sensor action detected	Check sensor action
<i>Aborted by Sensor</i>	Sensor action detected	Check sensor action
<i>Waiting for Sensor</i>	Sensor action detected	Check sensor action
<i>Motor Fault</i>	Motor controller stopped	Open lid / Press edit key to clear Shut down spin processor
<i>Motor Link</i>	No communication to motor controller	Open lid / Press edit key to clear Shut down spin processor
<i>Motor High</i>	High voltage detected by motor controller	Open lid / Press edit key to clear Shut down spin processor
<i>Motor Low</i>	Low voltage detected by motor controller	Open lid / Press edit key to clear Shut down spin processor
<i>Motor Short</i>	Motor detected a short condition	Open lid / Press edit key to clear Shut down spin processor
<i>Control Hot</i>	Motor controller stopped	Open lid / Press edit key to clear Shut down spin processor
<i>Motor Fault</i>	Motor controller stopped	Open lid / Press edit key to clear Shut down spin processor
<i>Exhaust Low</i>	Exhaust flow below lower set point	Check exhaust source Shut down spin processor
<i>Exhaust</i>	Exhaust flow above upper set point	Check exhaust source

<i>Hi</i>		Shut down spin processor
<i>Low Speed</i>	Failed to achieve target spin speed	Check for drag on chuck
<i>Need Lower Exhaust</i>	Exhaust flow too high	Check exhaust source Lower exhaust flow
<i>Exhaust Low</i>	Exhaust flow below lower set point	Check exhaust source Shut down spin processor
<i>Need Exhaust</i>	Exhaust flow too low	Check exhaust source Increase exhaust flow
<i>Running Purge</i>	Purge program running	Wait for purge program to stop before running next program.
<i>Ready Purge</i>	Purge program ready to run	Purge program is ready to run
<i>Done Purge</i>	Purge program completed	Purge program completed run
<i>Abort Purge</i>	Purge program aborted	Purge program aborted during run
<i>Hot Purge</i>	Motor hot while running purge program	Allow motor to cool before running next process
<i>Vac Purge</i>	Vacuum lost during purge program	Check vacuum source
<i>CDA Purge</i>	N2/CDA lost during purge program	Check N2/CDA source
<i>Paused Purge</i>	Purge program paused during run	Resume running by pressing the Start key
<i>Local Port</i>	Communication failure	Cycle power off and on. Try again if 1 st is not successful

Certain errors will cause the motor to shut down. The timer will stop. Pressing the “Edit” key clears errors and pressing the “Start” key will restart the program.

If an error condition occurs, check the following:

- Record the time, conditions, program number, program step, and error code
- Determine if error is due to vacuum loss or motor speed. Correct any obvious problems
- If condition persists, contact Support at support@laurell.com or 215-699-7278 for assistance
- Vacuum source
- Seal Purge source pressure ≥ 60 PSI required
- Lock out power supply and turn chuck by hand making note of any excessive drag

Note: Mechanical intervention during rotation is not permitted with this equipment design and damage caused is not covered by our warranty.

4.1.1 VACUUM LOSS (ON UNITS EQUIPPED WITH VACUUM SENSOR ONLY.)

- Vacuum readings >20" Hg typically indicate sufficient vacuum hold is present. <15" Hg vacuum (factory setpoint) is normally considered insufficient to operate safely. A flashing "V=XX" display is an insufficient vacuum indicator where XX is the actual vacuum value being read by sensor.

Note: the vacuum setpoint can be changed (contact the factory for the adjustment procedure)

4.1.2 REMOVING, CLEANING AND INSTALLING THE VACUUM VALVE

- The vacuum valve is an air operated valve with an internal piston. Chemicals such as photoresist or polyimides, which enter into the vacuum path, can prevent this piston from moving. The piston will fail to operate due to chemical contamination. If this happens and it is obvious that the vacuum valve is not functioning properly, the following procedure can be performed to clean the valve.
- **NOTE: FOLLOW THIS PROCEDURE CLOSELY AND BE CAREFULL NOT TO LOSE THE 3 SMALL O-RINGS!**

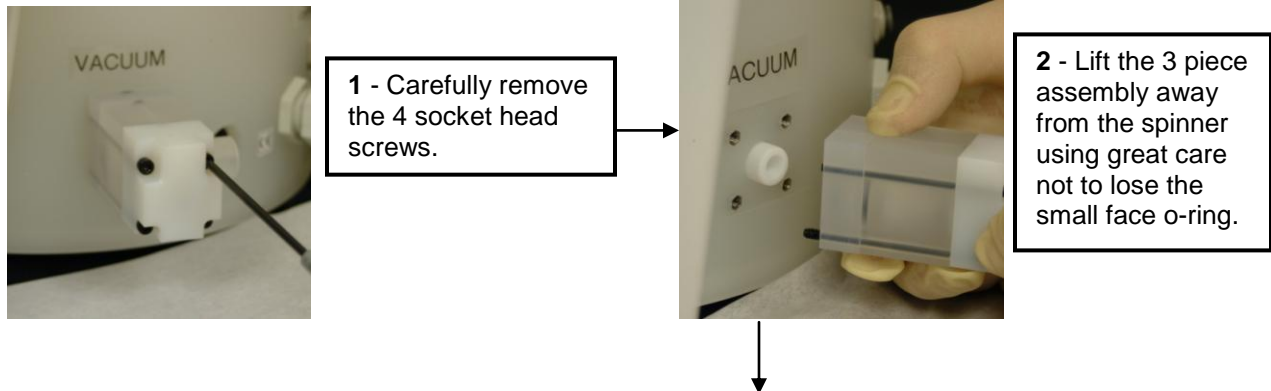

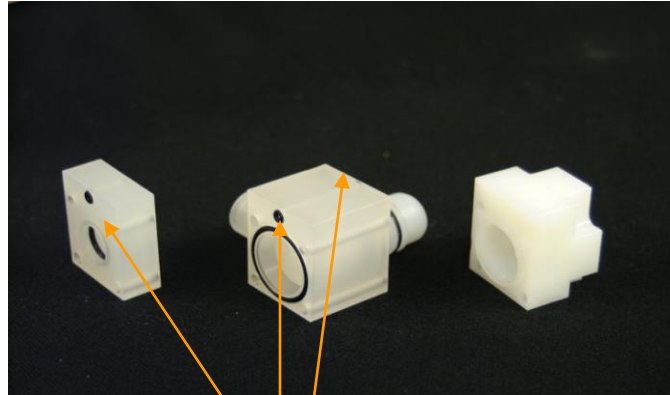

3 - The main assembly consists of 3 pieces and 3 small o-rings

Small o-rings

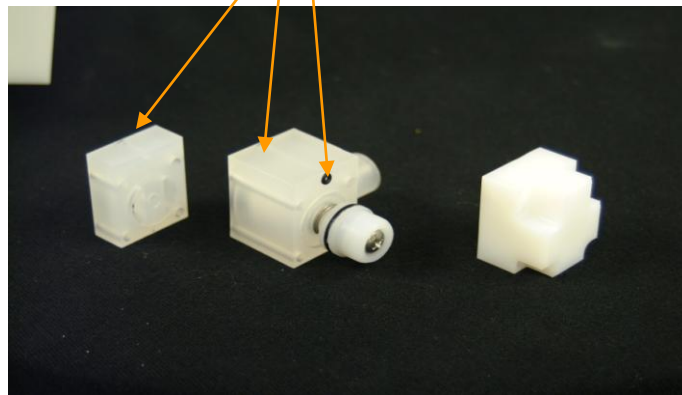

Backside view of the 3 piece assembly

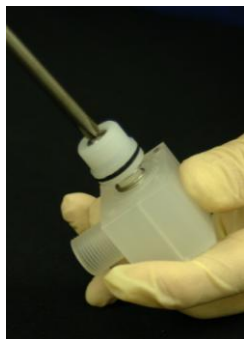

4 - If you decide to disassemble the valve, first remove the bell screw.

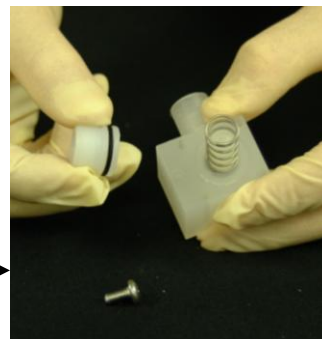

5 - After removing the screw lift off the bell and the actuation spring.

Keep track of all parts while cleaning, so as not to lose any for reassembly.

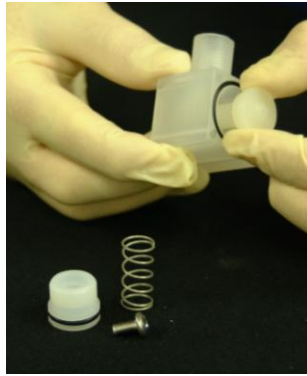

6 - Remove the piston by carefully sliding it out of the center assembly.

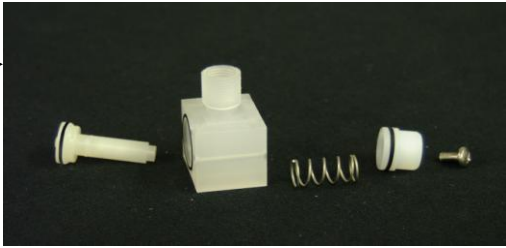

With the valve apart, hand clean with an appropriate solvent.

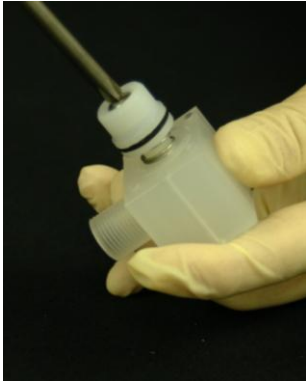

7 - Reassemble the center valve assembly in the same order that the valve was disassembled. If any o-rings or parts appear degraded, contact the factory.

Do not soak the piston in acetone. Always hand clean the piston. All other parts can be soaked in the appropriate solvent compatible with the user's chemistry.

Never scrape the parts when cleaning! This will degrade the tolerances needed for proper operation.

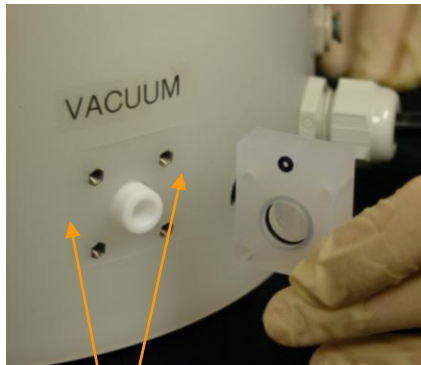

Vacuum Face Groove

8 - Take the first section and carefully snap into vacuum face groove, making sure that the o ring stays fully seated.



9 - Hold first section into groove and attach the two other sections.

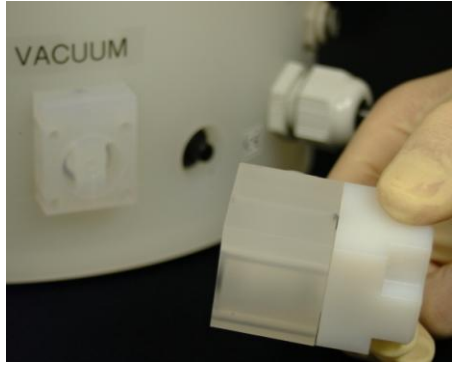

10 - Press the two remaining sections onto the first section, also making sure that the o-rings are firmly in place.

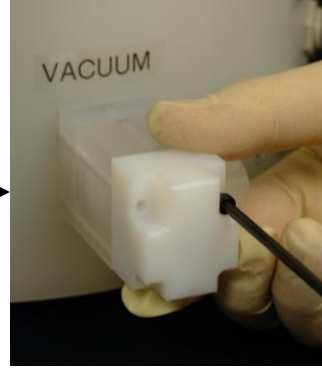

11 - With the entire assembly in tact, insert the first screw.



12 - Insert each screw loosely. **DO NOT** totally tighten until all four screws have been inserted.



13 - Tighten screws firmly, but do not over tighten. When tightening the screws, work in a criss-cross pattern.

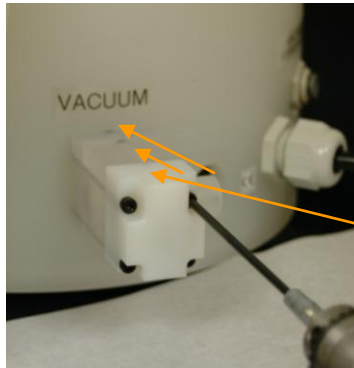

14 - Make sure screws are secure, but not over tightened.

Also check to see if all o-rings are in place.

4.1.3 VACUUM CHUCK WET TEST

- To prevent chemicals from entering into the vacuum path, the chuck and o-ring surface must be clean and defect free. A chuck wet test can be performed to check the integrity of the o-ring seal. See Fig.4-2. Using a clear substrate, place the wafer on the chuck and press the vacuum key. Using a bottle of DI water spray water around the periphery of the substrate where it meets the chuck while manually rotating the chuck. Check to see if there is any leakage across the o-ring.
- If there is no leakage, the chuck is ok to use.

- If leakage occurs, inspect the chuck and o-ring for defects. If the chuck is damaged it is recommended that it is replaced with a new Laurell chuck. If the chuck is defect free, wipe the chuck and o-ring surface with acetone or an appropriate cleaner. The cleaning solution or solvent must be compatible with the o-ring material. Repeat wet test. If wiping down the chuck and o-ring fails to prevent leakage remove and clean the o-ring. See section 4.1.4.



Figure 4-2
Wet Testing 1.75" and 200mm Chuck

4.1.4 CLEANING AND REPLACING THE CHUCK O-RING

To remove the o-ring from the chuck, insert a thin blunt instrument or o-ring puller into the o-ring groove and pull upward. Be careful not to damage the o-ring or chuck. Inspect the o-ring carefully. If the o-ring is cut, nicked or scratched it must be replaced. Contact Laurell for part number and ordering information. If the o-ring is in good condition, wipe it with a cleaner and insert it back into the o-ring groove. Use the following procedure to insert the o-ring.



1 - Carefully press the o-ring into the chuck face groove. Do so by pressing in a small section at a time.

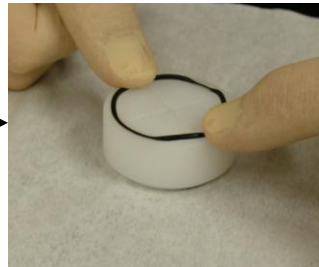

2 - After the small sections have been pressed in, carefully press around the chuck until the o-ring is fully seated.

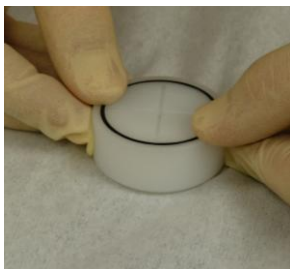

3 - The o-ring should lay flat in the groove.

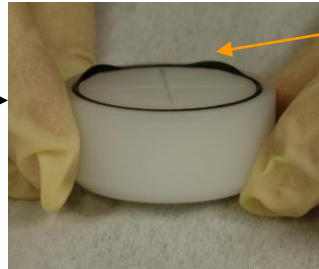

4 - There should not be any areas that do not lay flat. If this occurs, continue to press around the chuck until they are gone.



5 - Make a final check to be sure that the o-ring is entirely seated. Perform a chuck wet test to ensure o-ring sealing integrity.

4.1.4.1 O-RING COMPOSITION, USES & RECOGNITION

- We have determined that O-rings are the best way to insure a liquid-tight seal between the chuck face and a non-porous substrate. The O-ring provides a gripping as well as a sealing interface to our vacuum chuck and is normally provided in two standard materials, Viton and EPDM.

The type O-ring which is installed on your chuck has been determined by the chemicals which were specified when the spin processor was quoted. EPDM O-rings are most commonly used for solvents while Viton is the choice where acids or Toluene are present. You should determine before using the equipment what chemical you will be using as well as the type O-ring which is installed. A supply of both type rings are usually shipped with each system in properly labeled clear re-closable bags.

If O-rings become intermixed, an EPDM O-ring can usually be identified by the dull finish as opposed to the relatively smooth texture of the Viton material (some Viton O-rings are brown in color).

The vacuum chuck's O-ring seal should NEVER deflect ($> 0.002''$ / 50 microns). If you experience substrate deflection or breakage this is not a design issue but this is not normal so you **MUST STOP** immediately and contact our support department for application assistance. If you have thin or fragile material we have developed successful approaches to eliminate or minimize deflection and breakage.

When using the fragment adapter it is recommended that only one size O-ring should be used at a time. The simultaneous use of O-rings can add more grip and support to the substrate but if not absolutely identical thickness can cause a vacuum leak or even cause the material to break. When both O-rings are used an improper seal may develop allowing chemical to enter the vacuum path (a leading cause of machine failure). **Important:** The substrate must always fully cover the face of the O-ring being used.

Note: If you notice a black residue on the O-ring or marking of the holding surface either the O-ring is dirty or the material is being damaged by the process chemistry. **STOP** immediately especially if fluid passes the sealing surface after being under vacuum.

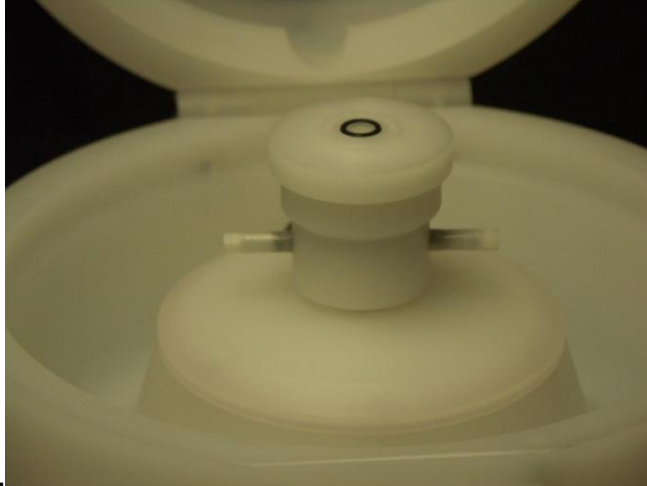

- The fragment adapter must be installed with a single o-ring for fragments.
- The inside o-ring is for fragments $\geq 11\text{mm} \times 11\text{mm}$.
- The outside o-ring is for fragments $\geq 20\text{mm} \times 20\text{mm}$.
- Only 1 size o-ring should be installed in the adapter at any one time.

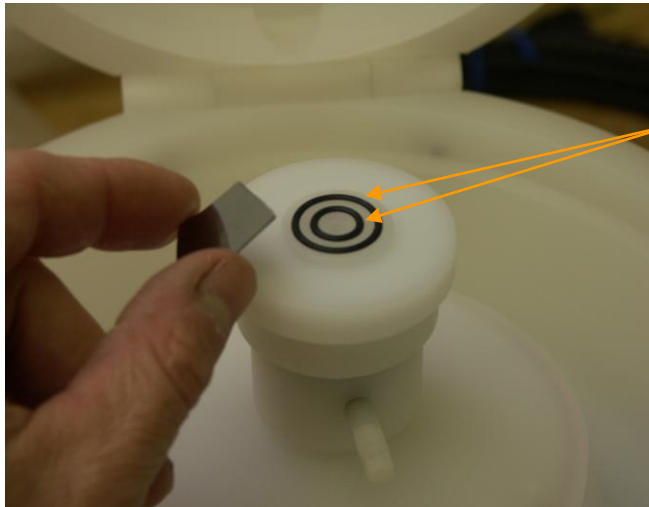

- Improper installation of two simultaneous o-rings on the fragment adapter.

4.1.4.2 O-RING PART LIST FOR WS-400X – xxNPP/TFM-LITE

LTC P/N	O-Ring Location	Qty	AS568B #	Material	Durometer	Compatibility
6200 2335	1.75" NPP/TFM LP Vacuum Chuck Face	1	028	EPDM	50	Solvents
6200 2336	1.75"NPP/TFM LP Vacuum Chuck Face	1	028	Viton	50	Acids & Toluene
6200 2363	100mm NPP/TFM LP Vacuum Chuck Face	1	042	EPDM	50	Solvents
6200 2364	100mm NPP/TFM LP Vacuum Chuck Face	1	042	Viton	50	Acids & Toluene
6200 2295	125mm NPP/TFM LP Vacuum Chuck Face	1	045	EPDM	50	Solvents
6200 2296	125mm NPP/TFM LP Vacuum Chuck Face	1	045	Viton	50	Acids & Toluene
6200 2297	150mm NPP/TFM LP Vacuum Chuck Face	1	159	EPDM	50	Solvents

Revision Date: 12/7/2011

6200 2298	150mm NPP/TFM LP Vacuum Chuck Face	1	159	Viton	50	Acids & Toluene
6200 2299	200mm NPP/TFM LP Vacuum Chuck Face	1	167	EPDM	50	Solvents
6200 2300	200mm NPP/TFM LP Vacuum Chuck Face	1	167	Viton	50	Acids & Toluene
6200 0251	NPP/TFM LP Vacuum Chuck Base – All Std. Chucks	1	024	EPDM	50	Solvents
6200 0046	NPP/TFM LP Vacuum Chuck Base – All Std. Chucks	1	024	Viton	50	Acids & Toluene
6200 2235	1.75" NPP/TFM Micro Fragment Adapter	1	001.5	EPDM	70	Solvents
6200 2236	1.75" NPP/TFM Micro Fragment Adapter	1	001.5	Viton	70	Acids & Toluene
6200 0274	1.75" NPP/TFM Mid Size Fragment Adapter	1	005	EPDM	70	Solvents
6200 0273	1.75" NPP/TFM Mid Size Fragment Adapter	1	005	Viton	70	Acids & Toluene
6200 0098	1.75" NPP/TFM Fragment Adapter - Small	1	011	EPDM	70	Solvents
6200 0099	1.75" NPP/TFM Fragment Adapter - Large	1	016	EPDM	70	Solvents
6200 0100	1.75" NPP/TFM Fragment Adapter - Small	1	011	Viton	70	Acids & Toluene
6200 0101	1.75" NPP/TFM Fragment Adapter - Large	1	016	Viton	70	Acids & Toluene
6200 2240	Pneumatic Vacuum Valve	3	003	EPDM	70	Solvents
6200 2134	Pneumatic Vacuum Valve	1	012	EPDM	70	Solvents
6200 0257	Pneumatic Vacuum Valve	1	014	EPDM	70	Solvents
6200 0099	Pneumatic Vacuum Valve	1	016	EPDM	70	Solvents
6200 0277	Pneumatic Vacuum Valve	1	020	EPDM	70	Solvents
6200 2397	Drain	1	031	EPDM	70	Solvents
6200 2121	Drain	1	031	Viton	70	Acids & Toluene
6200 0301	Down Flow Drain Adapter	1	034	EPDM	70	Solvents
6200 0302	Down Flow Drain Adapter	1	034	Viton	70	Acids & Toluene
6200 2232	Down Flow Drain Adapter – Side Window	1	039	EPDM	70	Solvents
6200 2231	Down Flow Drain Adapter - Side Window	1	039	Viton	70	Acids & Toluene
6200 0044	Stationary Seal	1	155	Teflon Encapsulated Silicone		Acids / Solvents
6200 0265	Motor Shaft – Standard Motor	1	017	Teflon Encapsulated Silicone		Acids / Solvents
6200 0265	Motor / Vacuum Coupling – Standard and HPD2	2	110	EPDM	70	Solvents
6200 0049	Upper Housing Lid –	1	170	Teflon Encapsulated		Acids / Solvents

Revision Date: 12/7/2011

All information contained in this manual is the property of Laurell Technologies Corporation® and is NOT to be edited, reproduced or distributed without express written permission from a corporate officer.

	6NPP/TFM			Silicone		
6200 0053	Upper Housing Lid – 8NPP/TFM	1	CALL	Teflon Encapsulated Silicone		Acids / Solvents
6200 0557	Upper Housing Lid – 23NPP/TFM	1	CALL	Teflon Encapsulated Silicone		Acids / Solvents
6200 2270	Upper Housing Lid – 15NPP/TFM	1	CALL	Teflon Encapsulated Silicone		Acids / Solvents
6200 2117	HPD2 Motor Adapter	1	032	EPDM	70	Solvents
6200 2118	HPD2 Motor Adapter	1	032	Viton	70	Acids & Toluene
6200 2217	Triple Labyrinth Seal	1	029	EPDM	70	Solvents
6200 2216	Triple Labyrinth Seal	1	029	Viton	70	Acids & Toluene
6200 2335	HPD2 - 1.75" NPP/TFM LP Vacuum Chuck Face	1	028	EPDM	50	Solvents
6200 2336	HPD2 - 1.75" NPP/TFM LP Vacuum Chuck Face	1	028	Viton	50	Acids & Toluene
6200 2363	HPD2 - 100mm NPP/TFM LP Vacuum Chuck Face	1	042	EPDM	50	Solvents
6200 2364	HPD2 - 100mm NPP/TFM LP Vacuum Chuck Face	1	042	Viton	50	Acids & Toluene
6200 2295	HPD2 - 125mm NPP/TFM LP Vacuum Chuck Face	1	045	EPDM	50	Solvents
6200 2296	HPD2 - 125mm NPP/TFM LP Vacuum Chuck Face	1	045	Viton	50	Acids & Toluene
6200 2297	HPD2 - 150mm NPP/TFM LP Vacuum Chuck Face	1	159	EPDM	50	Solvents
6200 2298	HPD2 - 150mm NPP/TFM LP Vacuum Chuck Face	1	159	Viton	50	Acids & Toluene
6200 2299	HPD2 - 200mm NPP/TFM LP Vacuum Chuck Face	1	167	EPDM	50	Solvents
6200 2300	HPD2 - 200mm NPP/TFM LP Vacuum Chuck Face	1	167	Viton	50	Acids & Toluene

Note: to find out actual physical dimensions of any size o-ring; use the AS568B #.as a reference. Many web site selling o-rings may list this information. One such site is O-rings West <http://www.oringswest.com>

4.1.5 MOTOR OPERATION

- Manually turn chuck and check for free movement and no binding. The motor should never be overloaded or held from turning.
- If RPM display shows zeroes when the chuck is actually spinning, this would indicate failure of the RPM sensor and a motor fault will appear.

4.1.6 MOTOR CALIBRATION

Calibration is used to adjust rotation performance by allowing fine-tuning of the motor controller for large changes in chuck and substrate mass, as well as motor efficiency corrections in time. This is performed at the factory and is normally not required again.

NOTE: Contact the factory for detailed instruction

Revision Date: 12/7/2011

All information contained in this manual is the property of Laurell Technologies Corporation® and is NOT to be edited, reproduced or distributed without express written permission from a corporate officer.

4.2 REPLACEMENT PARTS

Please visit our web site, <http://2k10.laurell.com/support/replacement-parts.php> for replacement parts and repair kit information.

4.3 WARRANTY

Warranty 1 year parts & labor - unit must be returned post paid to factory. No other warranties express or implied. Manufacturer makes no application claims. Failures due to misuse or abuse, disassembly, modification or for any other reason out of the control of the manufacturer voids all warranties. No returns permitted without authorization from the factory. Note: The Vacuum Pump option is separately warranted by the manufacturer for 1 year. All proposals are subject to final company approval before order acceptance.

SECTION 5 – APPENDIX

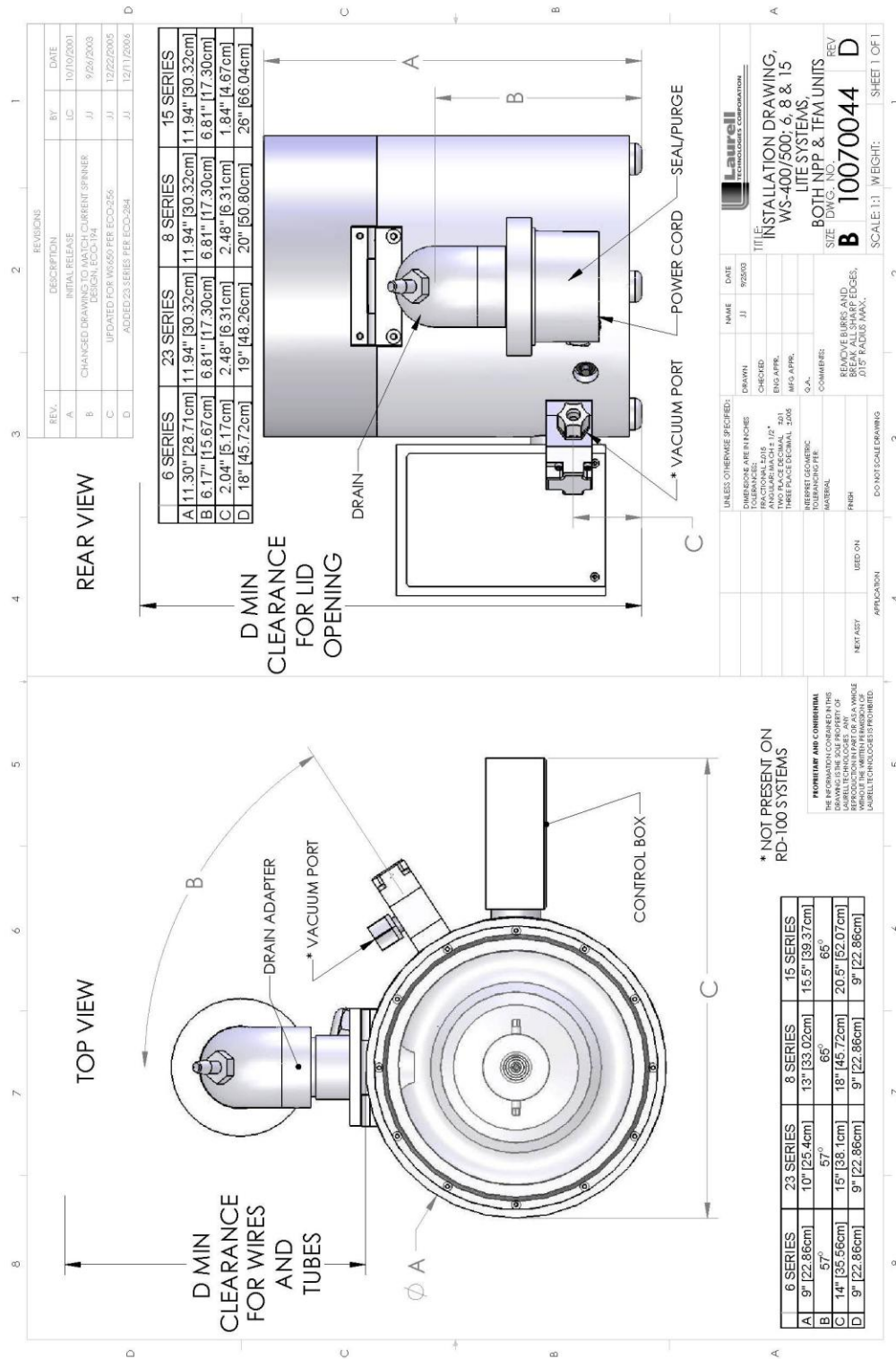

Figure 5.1
Dimensional Drawing – Lite Model – Tabletop

Revision Date: 12/7/2011

All information contained in this manual is the property of Laurell Technologies Corporation® and is NOT to be edited, reproduced or distributed without express written permission from a corporate officer.

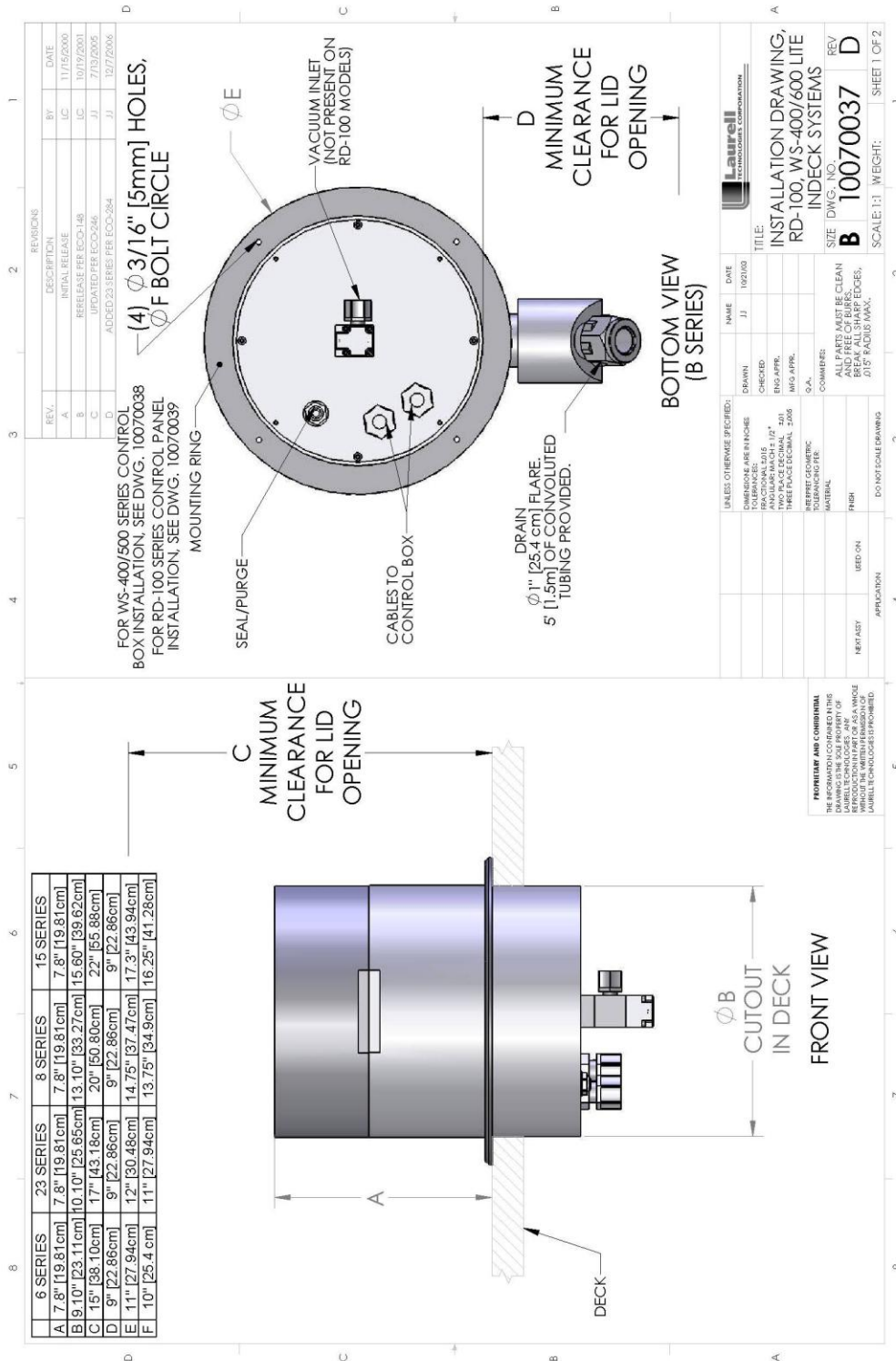

Figure 5.3
Dimensional Drawing – Lite Model - Indeck

Revision Date: 12/7/2011

All information contained in this manual is the property of Laurell Technologies Corporation® and is NOT to be edited, reproduced or distributed without express written permission from a corporate officer.

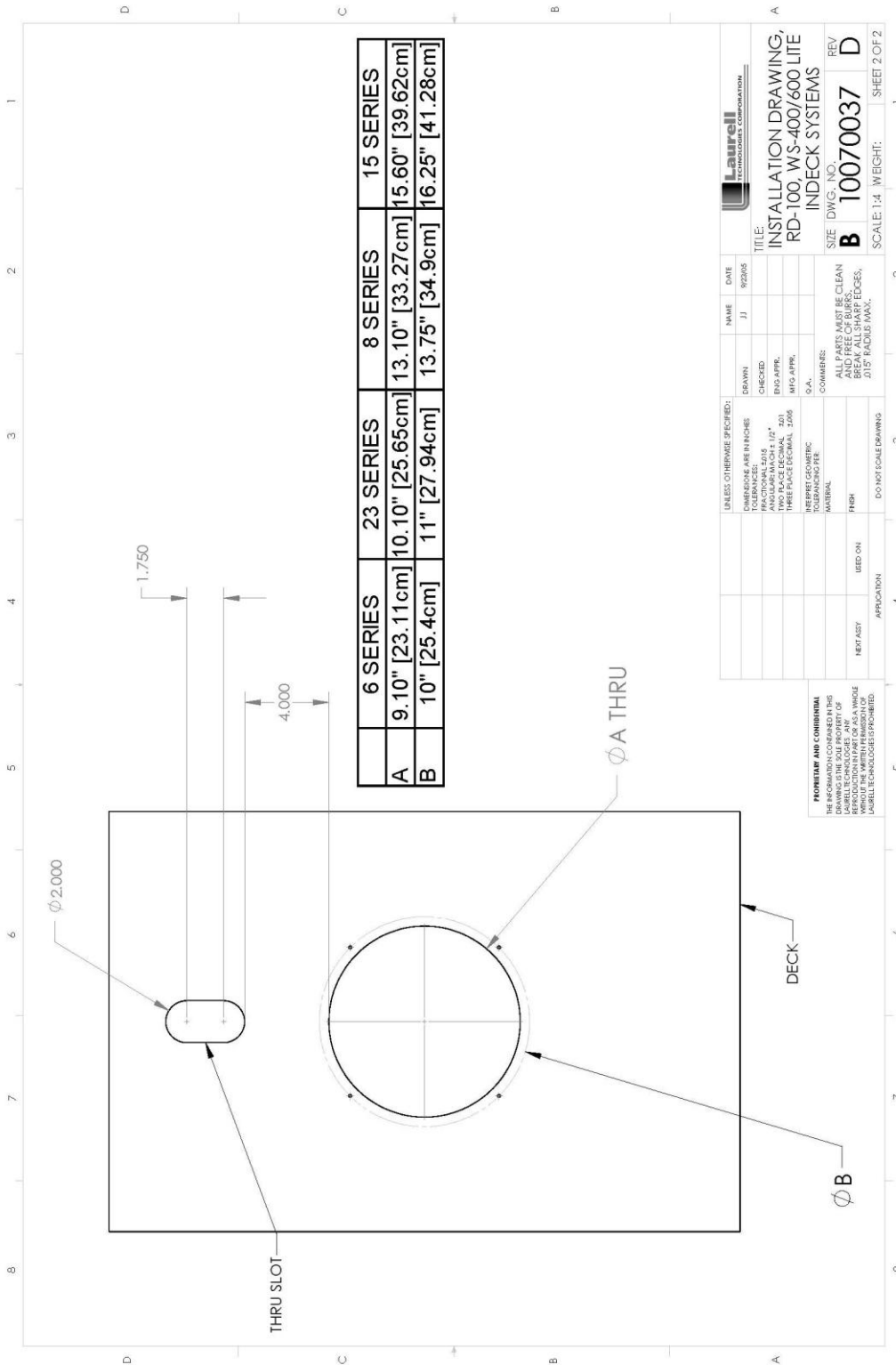

Figure 5.3.1
Deck Top Template - Lite - Indeck
(Spin Processor & Drain Tubing)

Revision Date: 12/7/2011

All information contained in this manual is the property of Laurell Technologies Corporation® and is NOT to be edited, reproduced or distributed without express written permission from a corporate officer.

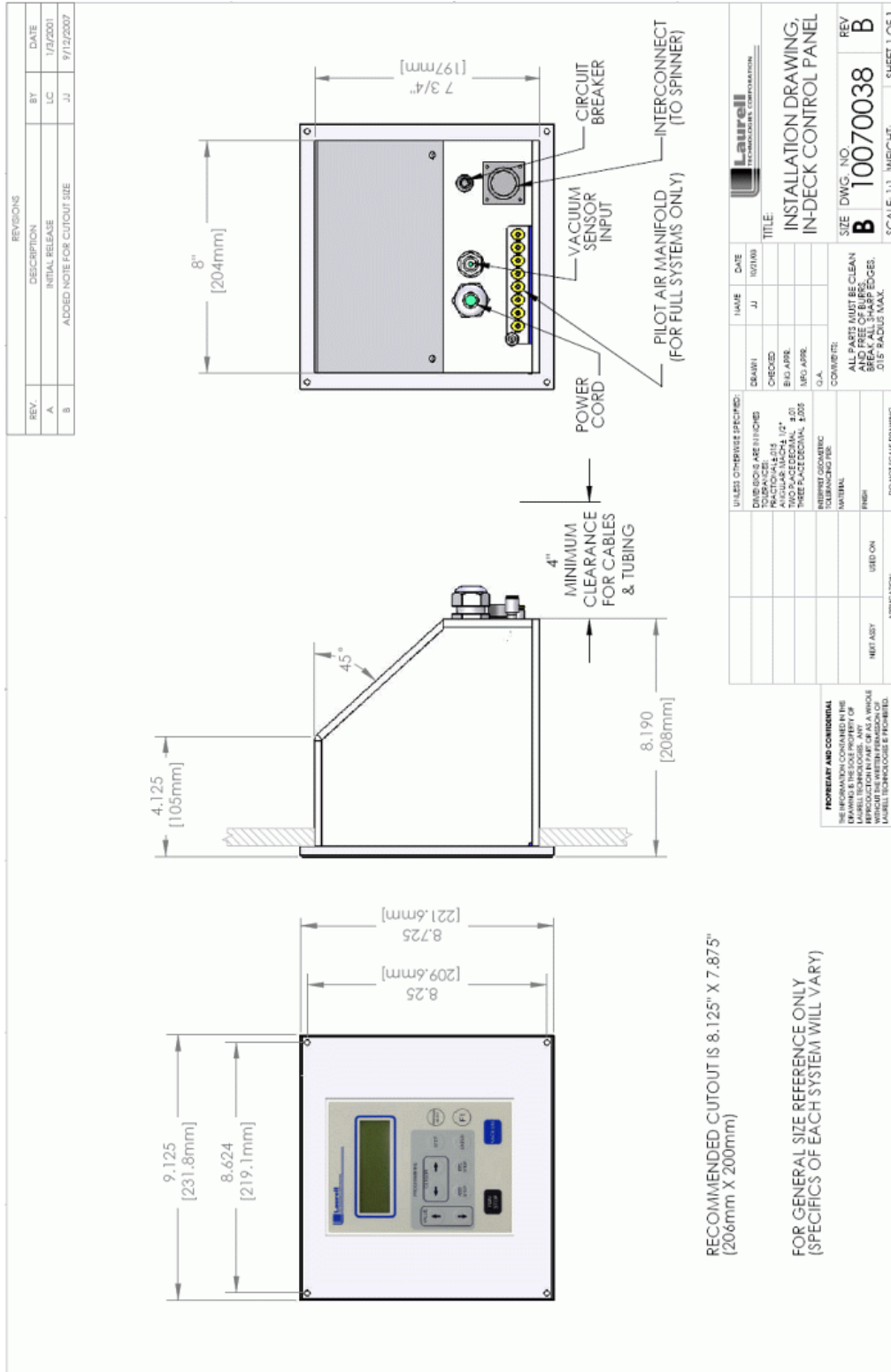

Figure 5.3.2
Dimensional Drawing – In-deck and On-deck Control Panel

Revision Date: 12/7/2011

All information contained in this manual is the property of Laurell Technologies Corporation® and is NOT to be edited, reproduced or distributed without express written permission from a corporate officer.

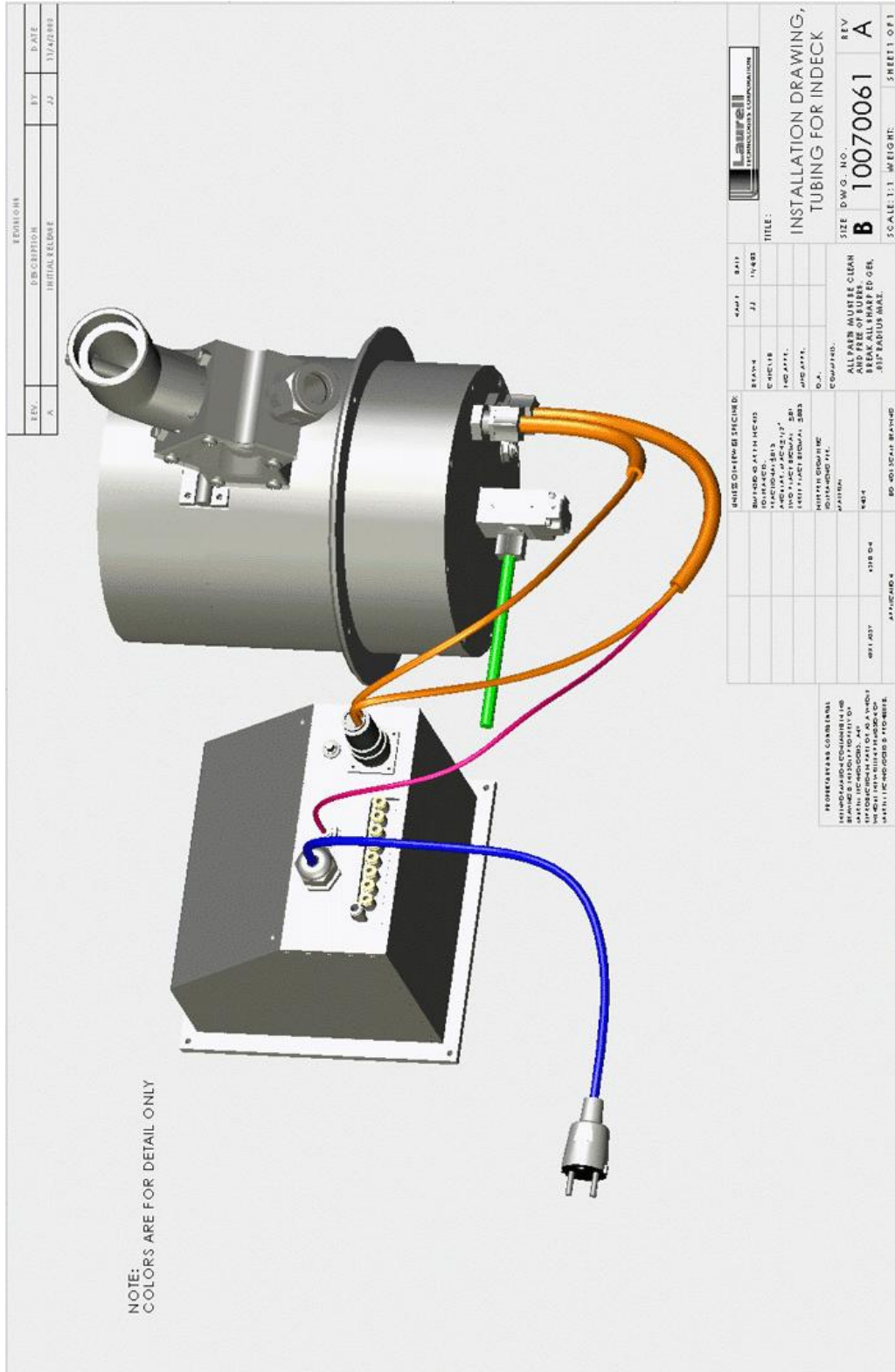

Figure 5.3.3
Installation Tubing for Indeck and Ondeck
(Remote controller shown with pilot air valves for Full systems only and optional downflow exhaust)

Revision Date: 12/7/2011