

Ney

NEYTECH Qex

Owner & Operator's Manual

Model No	Voltage	
94-94-400	100-120V	50/60Hz
94-94-401	230V	50/60Hz

Description	Page
Safety	2
Installation	3
Control Panel Description.....	4
Operating Instructions	5
Setup	8
Maintenance	9
Troubleshooting	10
Specifications	11
Service Parts	12
Declaration of Conformity.....	13
Accessories	14
Product Service	14
Warranty.....	Back

SAFETY



- Never operate furnace in close proximity to combustible materials or place materials on top of the furnace.
- The furnace must be electrically grounded to a three wire electrical outlet or receptacle. The electrical service provided must be a dedicated line of the proper size according to local electrical codes.
- Disconnect the line cord before attempting to service the furnace.
- Do not attempt to service the furnace until you read and understand the service manual. (See Manual under Accessories on page 11)
- Do not operate the furnace controls with tongs or other tools; the tongs will damage the control switches.
- Do not use solvents or liquid cleaners on the control panel; they will enter the panel and damage it.
- Do not place firing trays or other hot objects directly in front of the furnace; they will melt the graphic overlay.
- If the furnace is not used in the manner as specified in this manual, the protection provided by the furnace may be impaired.

OSHA AND CALIFORNIA PROPOSITION 65: MUFFLE DUST EXPOSURE

In keeping with the policy of Degussa-Ney Dental Inc. to build safe products, comply with all National and State statutes and keep you, the valued customer informed; the services of a Certified Industrial Hygienist firm were employed to test and evaluate the lab operator's exposure to respirable refractory ceramic fiber (RCF) and crystobalite (a form of crystalline silica) present in the furnace muffle.

When it becomes necessary to replace the muffle, the person doing this work is recommended to wear a HEPA filter respirator and protective gloves as a precautionary matter.



Seal used muffle in a plastic bag and dispose of in accordance with local, state and Federal regulations.

Because this product and many similar products on the market today contain crystalline silica and ceramic fibers, it is necessary under the statutes of California Proposition 65 that Degussa-Ney Dental Inc. include the following statement:

"This product contains substance(s) known to the State of California to cause cancer."

Material Safety Data Sheets for RCF materials supplied upon request.

SYMBOL TABLE

- Alternating current	Courant alternatif
I - On (Supply)	Marche (alimentation)
O - Off (Supply)	Arrêt (alimentation)
 - Caution, Hot Surface	Attention, surface chaude
 - Protective Conductor Terminal	Borne de masse, châssis
 - Caution	Attention

INSTALLATION

UNPACKING:

Carefully unpack and remove the furnace from its shipping carton. **Save the carton and other packing material for future use in transporting the furnace.**

Shipping damage should be reported to the carrier as soon as detected.

LIFTING AND CARRYING:

- Get a firm footing. Keep your feet shoulder width apart for a stable base.
- Bend your knees. Don't bend at the waist.
- Grip the handles of the packaging insert.

DO NOT LIFT FURNACE BY THE TOP MUFFLE ASSEMBLY!

- Keep the load close to your body and carry the unit to the destination. Keep your back upright during lifting.

The shipping carton contains the following:

- One furnace complete with power cord
- Owner & Operator's Manual (this document)
- Vacuum tubing, connections, and fuses
- Door insulation
- Card; Special Operating (2)
- Kit; Special, CD-ROM

INSTALLATION:

- Remove all packing material from in and around the furnace. The furnace should be located at least 15cm (6") away from walls, shelves and heat sensitive materials.
- The furnace should not be located directly under shelves or other airflow restrictions.
- **Furnace Connections:** Connect the furnace to a power circuit or receptacle with an overcurrent protection (circuit breaker or fuse) rating of 20 Amps (10A for 230V model). This circuit should be a grounded 3 wire circuit and only supply the furnace.

Electric Vacuum Pump Connections:

- Plug the external electric vacuum pump into the socket located directly below the furnace power cord. On the 230V model a short adapter cord is included which can be modified to the local wiring conventions if necessary. Customers with newer style pumps may not need to use adapter on 230V models.
- Connect vacuum pump hose to barbed fitting.

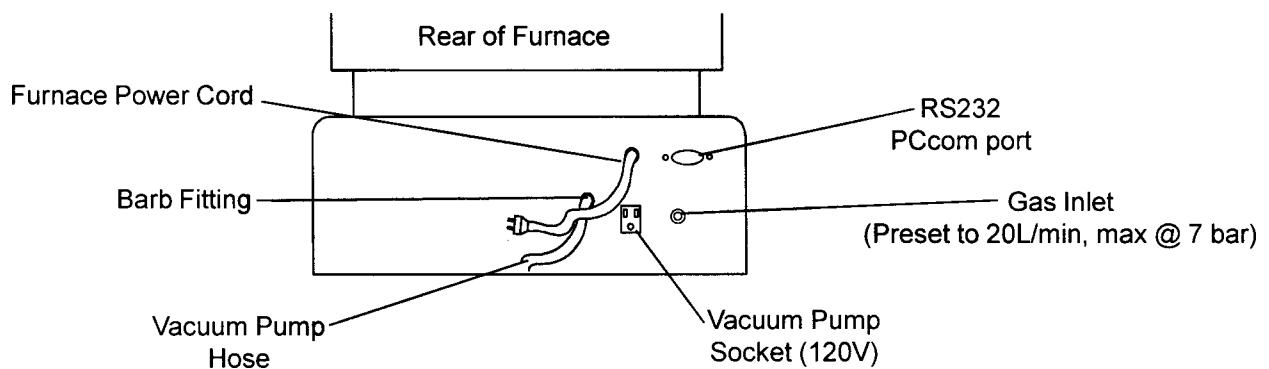

CONTROL PANEL DESCRIPTION

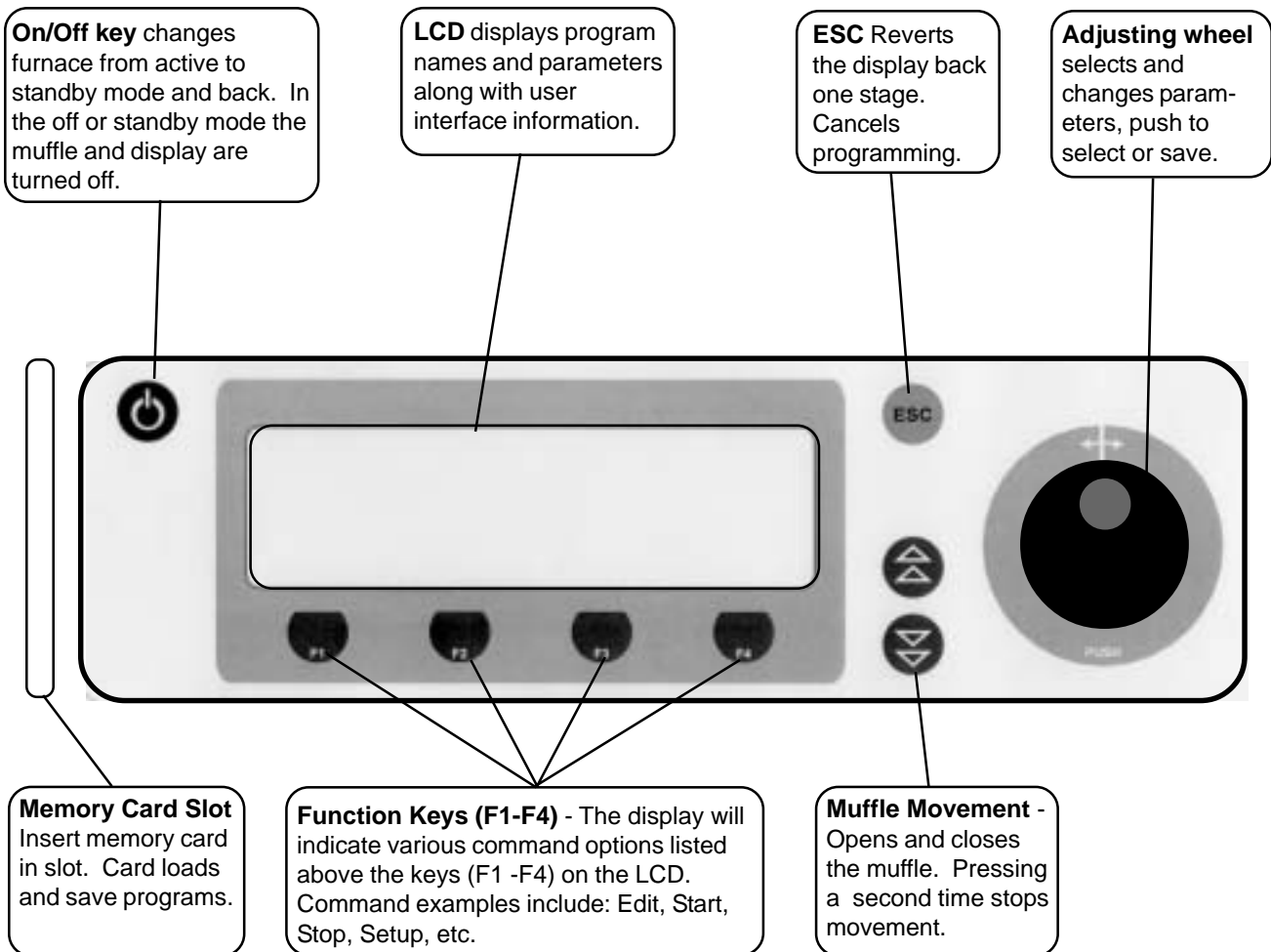

LCD DISPLAY DESCRIPTION:

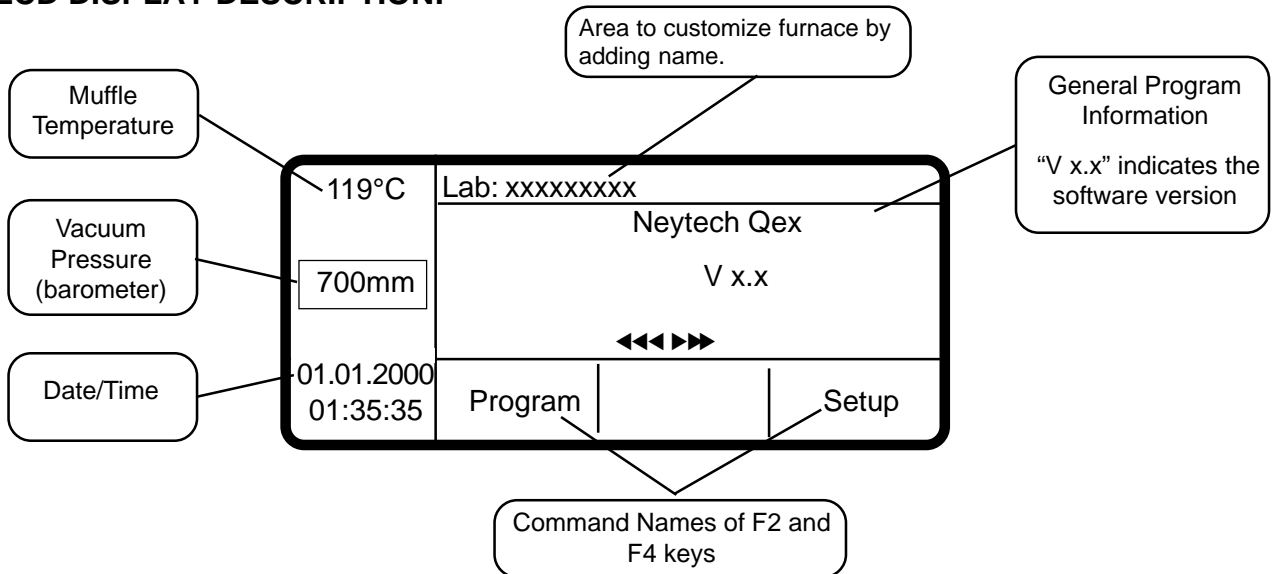

OPERATING INSTRUCTIONS

WARNING: The furnace must be installed properly before operation. Please read and implement the installation instructions before operating.

GETTING STARTED:

- **FIRST TIME ONLY:** Plug the line cord of the furnace into a power circuit. The furnace will go through a series of self-diagnostic tests. The muffle will open.

The furnace is shipped with packing material inside the muffle. Remove this material before any keys are pressed.

- Install the ceramic door insulation.

Operating the furnace without this platform will damage the furnace!

Note: If the operation of the furnace causes the lights to "blink" or "flicker" the furnace is on the same circuit breaker or fuse as the lighting. Install the furnace on a separate circuit that is isolated from the lighting circuit.

- Press the **On/Off Key**

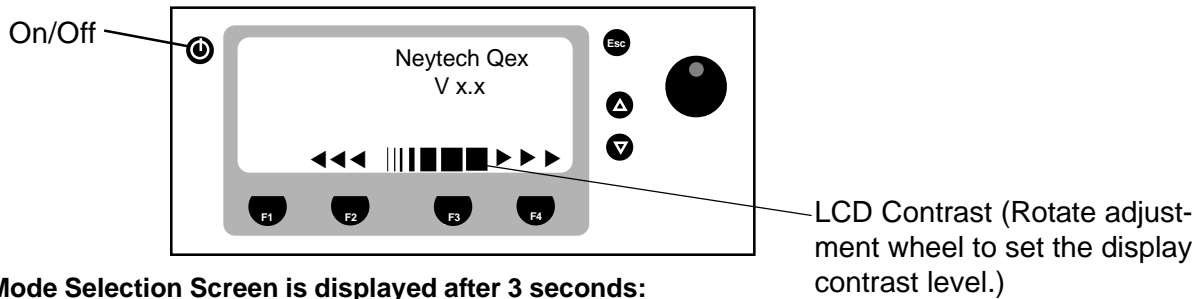

Mode Selection Screen is displayed after 3 seconds:

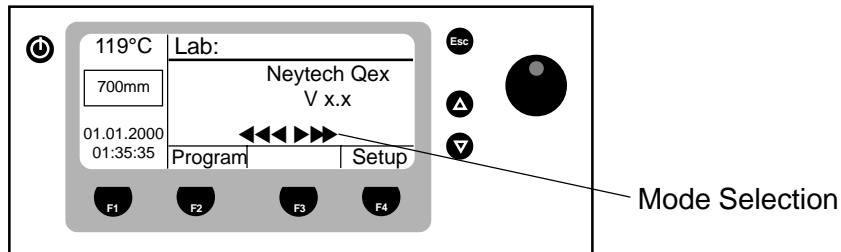

There are 2 menu options displayed above the function keys.

Program - Loads Neytech programs from EEPROM memory.

Setup - Support programs and operations such as set time / date, calibration offset, program locking and memory card operations.

- The highlighted function key can also be activated by pressing the **Adjusting Wheel**.
- To operate the unit, it must be loaded by a Program memory card, by the PC, or from one of the 6 available programs.

CARD OPERATION:

Operation from card:

To start a firing program from a memory card insert the Program card.

The contents of this card are now available to the Qex by pressing F2. The display shows all 6 available programs.

PC OPERATION:

Connect the RS-232 cable to the rear of the furnace and press PC > Qex on the computer (see “Neytech Programming Manual”). All six (6) programs are now downloaded to the Qex. After the transmission (the program listing screen appears).

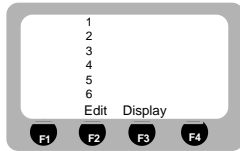

Display - Lists all parameters of the selected programs before starting the program.

Edit- Activates the edit mode. The screen is divided into two parts. The left side shows various parameters which may be selected and added to the program which is shown on the right side. A new program name can also be entered. (See Operations and Programming Examples).

Parameter	Description	Programming Range
Gas Rate & Temp	Activates Gas solenoid Change of temperature per minute to a specified temperature.	0 = off, 1 = on .1 -9.9°C/min 10-220°C/min (positive or negative) 50°C - 1200°C
Pos & Time	Muffle goes to position for specified time.	0 - 9 (0 = closed) 00:00 - 59:59 min
Hold Vacuum	Controls temperature for specified time Turns vacuum pump On, Off or leave on continuously.	00:00 - 59:59 Hrs On, Off, Cont
Tone Wait & Tone	Operator alert during program. Controls temperature indefinitely until manually instructed to continue the firing cycle. (Press function Key F4 to continue).	0 - 9 0 - 5

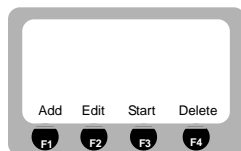

Add - Activates the parameter selection process. Turning the adjusting wheel moves the cursor from parameter to parameter. Select a parameter and press **Add** again. This parameter is now enhanced and turning the adjusting wheel moves the program cursor (located in the right field). A new parameter will always be added above the program cursor location. Press **Add** again to include the selected parameter into the program. Repeat this process until the program has all the parameters required.

Edit- The new parameters can now be modified by turning the adjusting wheel.



Save - Stores the modified parameter in permanent memory, a small delay, while the program is being saved, will be experienced. (See “Operation and Programming” example).

Delete - Removes parameters from a program. Place the program cursor to the particular parameter and press the function key F4 (Delete). This parameter is now enhanced. Press ESC if this command is no longer valid. Pressing Delete again remove this parameter from the program. Deleted parameters are not saved to EEPROM unless an Add or Edit command is used and Save is pressed.

Start - Starts the firing program. The start function key is replaced with **Stop**. After completion of a parameter command the next parameter will be moved up on the screen.

OPERATION AND PROGRAMMING EXAMPLES:

The supplied program card contains a sample program called "Example" in order to illustrate the special program operation in more detail.

Loading the Programs

- Press ESC until the display shows the Mode Selection Screen. Insert the program card (label towards display) and observe the message on the display. Press card (F2) to view the programs on the card.

Viewing the Program

- Turn the adjusting wheel so that the cursor points to program 6. Press the function key F3 (Display). The display shows the parameters of program 6 called "Example".

Explanation of Program Parameters

- The first parameter Set Pos 0 & Time 0:00 will bring the muffle to the down position at its fastest speed. The second parameters Hold 0:10 leaves the present condition unchanged for 10 minutes. Note: At this stage there is no temperature control. The third parameter Pos 9 & Time 0:20 brings the muffle to the up position for a duration of 20 seconds. The last parameter aborts the firing cycle.

Running the Program called Example

- Bring muffle to the up position.
- Press "Start" and observe the display. The blinking cursor indicates the segment on which the control is operating. After completion the next parameter is placed on the first line. At the end of the program muffle is turned off and the display shows the program listing again.

Editing the Program called Example

- Turn the adjusting wheel until the cursor points to program 6, then press the Edit key. The program cursor points to "Pos & Time".
- To change the position to 4, press the function key "Edit" and turn the adjusting wheel clockwise until the display shows Pos 4. Press the function key "Save" to store this setting.
- To change the Hold 0:10 min to hold 0:15 min, turn the adjusting wheel to Hold, press "Edit" and turn the wheel until Hold 0:15 min is shown, then press "Save".

Adding a Program Parameter

- To add a parameter press the function key "Add". Turn the adjusting wheel to Tone and press "Add" again.
- Turn the adjusting wheel to move the cursor in the program where to place the parameter Tone. Turn the wheel to Pos 9 and press "Add". The new parameter Tone is now placed above the parameter Pos 9 in the program. To Edit the parameter "Tone" follow the edit instructions above.



Deleting a Program Parameter

- Turn the adjusting wheel to move the cursor in the program to the parameter to be deleted. Turn the wheel to Tone and then press "Delete". Verify that this is the parameter to be deleted and press "Delete" again. The parameter "Tone" is now removed, press EDIT, press SAVE to save these changes to permanent memory.

Editing the Program Name

- From the program listing screen, select a program and press Edit. Turn the adjusting wheel counter clockwise until a blinking cursor is visible in the program name field. Press >>Set>> and select the first character by turning the adjusting wheel. Press >>Set>> to select the next character, after all characters are selected press Save.

Storing the Program on the "Program" Card

- After completing a program from the "Edit" mode press the function key "ESC" to display the program listing screen. Press ESC again and the mode selection screen is displayed. Press the function key "Setup" and turn the adjusting wheel to Prog  . Press the adjusting wheel to save the "Program" to the memory card.

SETUP

The **Setup** screen provides operator access to a number of furnace controls and features. The **Setup** mode is accessible from the mode selection screen.

- Press **Setup** key
- Turn adjusting wheel clockwise to move the cursor to an operation.

Press the adjusting wheel to select the operation.

Calib Temp: Adjustment to furnace temperature calibration. Range is + 30°C to -30°C. Factory setting is 0. The value added / subtracted from 960°C (silver melting temperature).

Set Time (date): Turn the adjusting wheel to change the value and push to advance to the next number in time and date display.

Edit Lab: Turn the adjusting wheel to Lab Name and push the wheel. The name of the company can be written. It then will be displayed at the "Select Mode" screen. (See "Entering a Program Name", pg.7)

Program to Card Transfer

Prog >>> : User can store the Special programs from the Qex memory card.

- Select **Setup** from Mode Selection Screen
- Insert Card
- Move cursor to "**Program to **", push wheel
- After the programs are downloaded, the current date/time is written on the card.

Card to Program Transfer

 **>>> Prog** : Loads the memory card programs into the Qex. To download from the card to the Qex:

- Select **Setup** from Mode Selection Screen
- Insert Card
- Move cursor to "** to Program**", push wheel
- All programs are then transferred to card

(Note: Existing programs will be overwritten)

Clear Card Programs

Clear  : Erases all programs contained on the "Program" card.

- Insert Card
- Turn the adjusting wheel to **Clear** and press the wheel. On the right most "Function Key" the word "Clear" will appear. Press this key to delete all programs from the card.

Prog Edit: Locks or unlocks the program editing operation. To activate this feature push the adjusting wheel and dial a code between 1 and 1200. Press the adjusting wheel and a locked symbol () will appear. To unlock the edit function repeat the procedure and dial the previously entered code.

MAINTENANCE

General

Maintenance and care includes work which ensures perfect operational reliability of the Neytech Qex .

- Check the unit for mechanical damage in regular intervals. In this way accidents and unit breakdowns can be prevented.
- Immediately remove contaminations from all movable components.

 Before using any cleaning or decontamination method except those recommended by Degussa-Ney. User should check with Degussa-Ney that the proposed method will not damage equipment.

 Prior to cleaning, the unit must be switched off and unplugged.

 When cleaning the unit make sure that no moisture can penetrate into the unit. In this way you avoid short circuits which may result in the breakdown of the unit or in setting the unit on fire.

 Do not open the unit. Hazardous voltages have been applied in the unit. Repairs must only be performed by authorized service technicians.

 Manipulations of the unit reduce the operational reliability and include the risk of damage to persons or materials.

 User has the responsibility for carrying out appropriate documentation if a hazardous material is spilt on or inside the equipment.

 Before using any cleaning or decontamination method except those recommended by the Degussa-Ney, user should check with Degussa-Ney, that the proposed method will not damage the equipment.

Replacement Fuses:

Receptacle: F250V, 10A (230V only) PCB-F1: F250V, 1.0A

TROUBLESHOOTING

Error Messages

In the event the microprocessor detects a malfunction the display shows an error window with a brief description and Err number. Except for vacuum and motor lift errors the Qex aborts the firing cycle, the power relays open, an audible warning signal can be heard and the operator must unplug the unit from the AC line.

- Err 1 • **No Temp Signal**
The thermocouple is open
- Err 2 • **Temperature too high**
The thermocouple reading is above 1210°C
- Err 3 • **No Temp Increase**
A thermocouple was installed with the wrong polarity (backwards).
- Err 4 • **Triac Shorted**
The muffle current sensor detected no current control (always on).
- Err 5 • **Muffle Open**
The muffle current sensor detected no current.
- Err 6 • **No Vacuum**
The vacuum sensor reading does not change:
 - Check hose, electrical pump connections
 - Check proper door closure
- Err 7 • **Low Vacuum**
The vacuum level achieved is not acceptable for porcelain firing:
 - Check pump performance
 - Check proper door closure
- Err 8 • **Motor too Slow**
The muffle travel took longer than 12 seconds:
 - Check for excessive friction or interference.
- Err 9 • **Motor: No Signal**
The motor position sensor reads outside its operating range.

SPECIFICATIONS

OPERATIONAL

- Temperature Accuracy: +/- 3°C at steady state
- Muffle Temperature Uniformity: +/- 5°C at steady state

ELECTRICAL

Voltage Ranges:	100-120V	230V	
	50/60Hz	50/60Hz	
Currents:	13.0 Amps @ 100V	7.2 Amps @ 220V	
	14.5 Amps @ 120V		

Wattage: 1740 Watt, with 300 Watt pump
 Watt to Maintain 1000°C: less than 400 Watt, muffle closed, no vacuum pump

MECHANICAL

Exterior Dimensions:	Height	Width	Depth	
Muffle open	46cm (18")	33cm (13")	45cm (17.7")	
Muffle closed	30cm (12")	33cm (13")	42cm (16.6")	

Interior Muffle Dimensions:
 Height: 6.3cm (2.5") Diameter: 10cm (4")
 Furnace Weight: 25Kg (55lbs) Shipping Weight: 30Kg (66lbs)

ENVIRONMENTAL

Ambient Operating Temperature: 5 - 40°C
 Relative Humidity: Maximum 80%, non-condensing

OUTLINE DRAWING:
 in (mm)

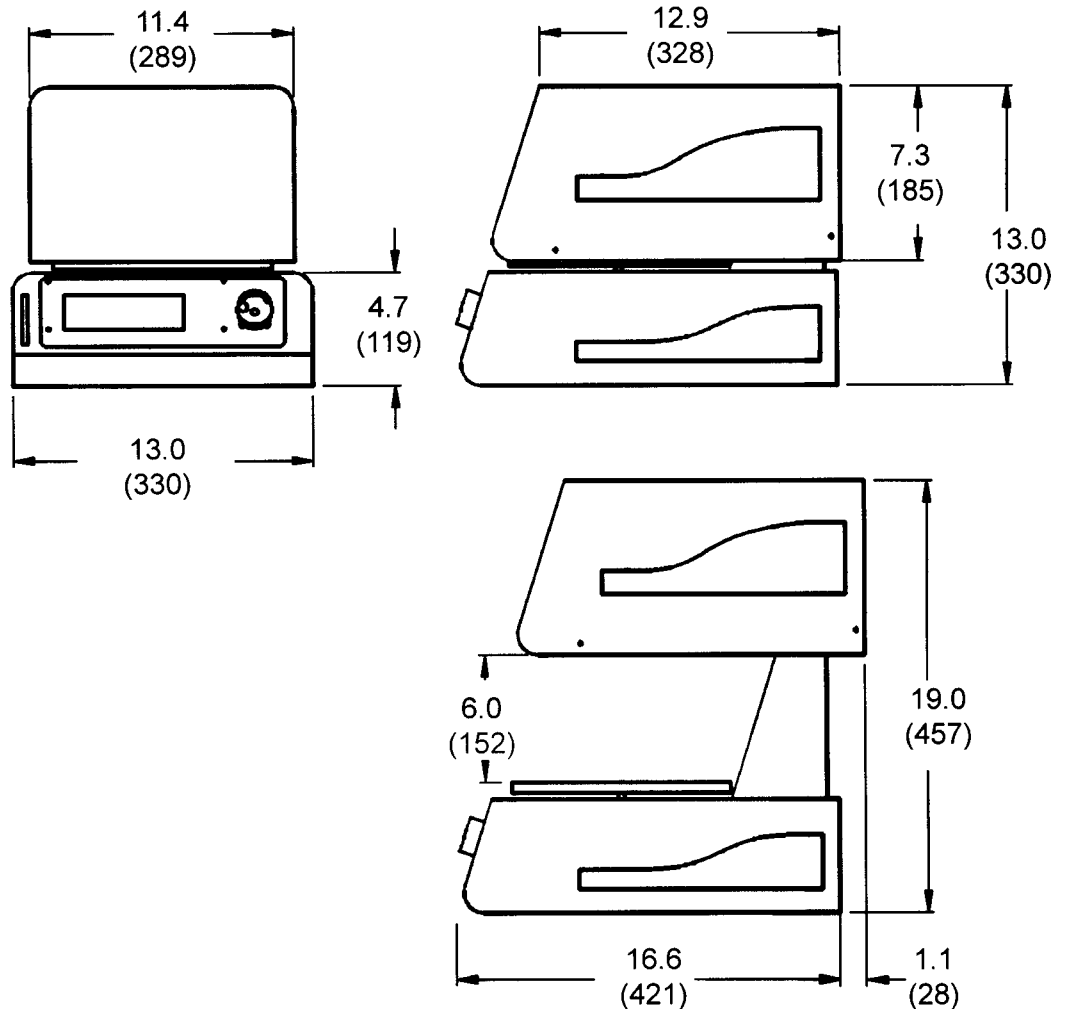

SERVICE PARTS

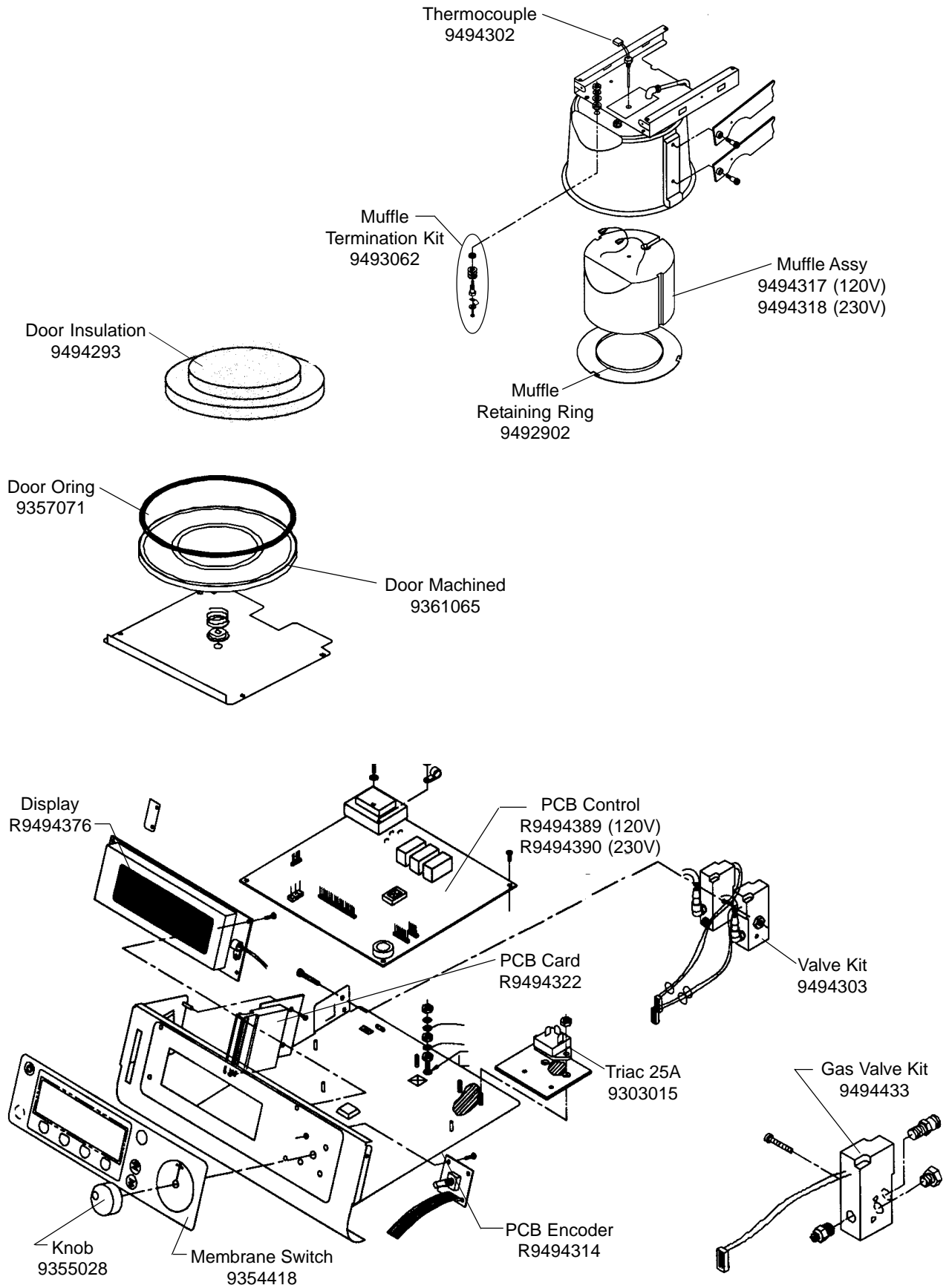

DECLARATION OF CONFORMITY

Degussa-Ney Dental Inc.

13553 Calimesa Blvd.
Yucaipa, CA 92399
USA

Degussa-Ney Dental Inc. certifies that the following product:

Names: **Neytech Qex**

High Temperature Vacuum Furnace

Serial Numbers: GWE xxxx-xxx (Where x is a number from 0-9)

Conforms with the basic requirements of the following EC guidelines:

- Low Voltage Directive 73/23/EEC
with 1. Modification 93/68/EEC
- EMC - Electromagnetic Compatibility 89/336/EEC
with 1. Modification 92/31/EEC
2. Modification 93/68/EEC

The following Harmonized Standards were applied:

- EN 61010:1993 + A2:1995 (Safety)
- EN 61010-2-010:1992 + A1: 1996 (Safety)
- EN 61326:1998 (EMC)

Degussa-Ney Dental Inc.'s quality system meets these requirements:

- ISO 9001:1994 (Quality)

Our European Representative is:

Eamonn deBarra
12 Fitzhaven Square
South Circle Road
Limerich, Ireland

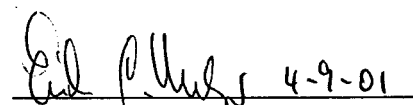
Erich Melzer
Electronic Project Engineer

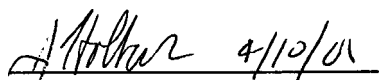
John Holbeck
Mechanical Project Engineer

Rich Roy
Director / General Manager

ACCESSORIES

DESCRIPTION	PART NUMBER
Tongs; 25cm (10") Stainless Steel	93-90-014
Tongs; 30cm (12") Stainless Steel	93-90-015
Vacuum Pump; 100-125V; 50/60Hz	94-94-198
Vacuum Pump; 220-250V; 50/60Hz	94-94-199
Kit; Special, CD-ROM	94-94-407
Card; Program	94-94-408
Service Manual, Qex	93-63-133

PRODUCT SERVICE

Three methods of product service are available for the NEYTECH Qex . The first is telephone assistance available at the numbers listed below. The second is to return the furnace for servicing using the instructions below. The final is to call Degussa-Ney at the phone numbers below and obtain a service manual for a nominal fee.

BEFORE PACKING THE FURNACE, DO THE FOLLOWING:

- Remove all firing trays, work platforms, and other loose items from inside the muffle.
- The original packing material should be used for the return shipment. Contact Degussa-Ney for replacements if they are not available.
- Call Degussa-Ney for an RMA number (Return Material Authorization). This is used to track and identify your furnace. Material received without this number may not be identifiable.
- Equipment damaged in shipment as the result of improper packing may not be paid by the carrier. Degussa-Ney Dental Inc. will not be responsible for damages resulting from improper packing.

Ship Prepaid To:	Degussa-Ney Dental Inc.
	Equipment Division
909.795.2461	RMA Number _____
FAX 909.795.5268	13553 Calimesa Blvd.
	Yucaipa, CA 92399-2303 USA

WARRANTY

WARRANTY: Except with respect to those components parts and uses which are hereinafter described, Degussa-Ney Dental Inc. (Degussa-Ney) warrants this furnace to be free from defects in material and workmanship for a period of two years from the date of sale. Degussa-Ney's liability under this warranty is limited solely to repairing or, at Degussa-Ney's option, replacing those products included within the warranty which are returned to Degussa-Ney within the applicable warranty period (with shipping charges prepaid), and which are determined by Degussa-Ney to be defective. This warranty shall not apply to any product which has been subject to misuse; negligence; or accident; or misapplied; or modified; or repaired by unauthorized persons; or improperly installed.

INSPECTION: Buyer shall inspect the product upon receipt. The buyer shall notify Degussa-Ney in writing of any claims of defects in material and workmanship within thirty days after the buyer discovers or should have discovered the facts upon which such a claim is based. Failure of the buyer to give written notice of such a claim within this time period shall be deemed to be a waiver of such claim.

DISCLAIMER: The provisions here-in stated Degussa-Ney sole obligation and exclude all other remedies or warranties, expressed or implied, including those related to *MERCHANTABILITY* and *FITNESS FOR A PARTICULAR PURPOSE*.

LIMITATION OF LIABILITY: Under no circumstances shall Degussa-Ney be liable to the buyer for any incidental, consequential or special damages, losses or expenses.

LIMITATION OF ACTIONS: The buyer must initiate any action with respect to claims under the warranty described in the first paragraph within one year after the cause of action has accrued.

Corporate and Sales Office:
DEGUSSA-NEY DENTAL, INC.
65 West Dudley Town Road
Bloomfield, CT 06002-1316 USA
860.242.6188
FAX 860.769.5050

Product Service Office:
DEGUSSA-NEY DENTAL, INC.
Equipment Division
13553 Calimesa Blvd.
Yucaipa, CA 92399-2303 USA
909.795.2461
FAX 909.795.5268