

SERVICE MANUAL

8003 Trotec Speedy C12
8003 Trotec Speedy C25
8003 Trotec Speedy C50
8003 Trotec Speedy C100

Trotec Produktions- u, Vertriebs GmbH
Linzer Straße 156
A-4600 Wels

Tel: ++43/7242/239-0
Fax: ++43/7242/239-7380
E-Mail: TROTEC@trodat.net

Version 1.1
January 1999

This publication and its contents are proprietary to Trotec Wels and are intended solely for the contractual use of Trotec customers.

This publication and its contents may not be reproduced or distributed for any other purpose without the written permission of Trotec Wels.

Notice

Trotec Wels does not assume any liability arising out of the application or use of any products, circuits or software described herein. Neither does it convey a license under its patent rights nor the patent rights of others. Trotec Wels further reserves the right to make any changes in any products described herein without notice. This document is subject to change without notice.



CAUTION

Use of controls or adjustments or performance of procedures other than those specified herein may result in hazardous laser radiation exposure.

Table of contents

1. Main components of the Speedy laser engraver.....	5
2. Safety information.....	7
General	7
Laser Safety	9
US laser classes.....	9
Safety Interlock System	11
Dangers of Electricity.....	12
Emission indication and safety labeling	13
Light Emitting Diodes.....	13
Audible Warning	13
Safety Labels	14
3. Laser beam alignment on Speedy	15
4. Laser pointer adjustment	20
5. Replacing the laser tube	22
Measuring the laser power:	23
Laser tube replacement (12W and 25W)	25
Laser tube replacement (50W and 100W)	26
6. Adjusting the Software	28
Adjusting the tickle power.....	28
Adjusting the Power Correction factor CL:	30
Adjusting the Offset parameters:	31
Overtook adjustment:	33
Tab „correction“ in the service setup	34
Tab „acceleration“ in the service setup.....	35
7. Adjusting the Hardware	36
Ruler adjustment and rectangularity adjustment of the motion system	36
How to check the ruler position	37
Ruler adjustment.....	38
Rectangularity adjustment of the motion system.....	38
Table adjustment.....	40
8. Servicing the X axis.....	44
9. Special instructions for X-belt tensioning	50
10. Instructions for changing the X-gearing assembly.....	53
11. Servicing the Y axis left part.....	56

12. Servicing the Y axis right part 60

13. The electric system of the Speedy..... 63
 Block wiring diagram 64
 Connector Assignment..... 65
 Checking the different components: 66

14. Firmware Update..... 67
 Steps for updating the firmware 67

15. Network installation of Trotec laser engravers 69

16. Software tips&tricks 72
 Rastering images in Corel Draw 72
 How to produce a Seal Press..... 73

17. Marking metals using metal mark paint 74

18. Speedy error codes..... 75
 Software feedback75
 Hardware feedback78

19. FAQ's..... 80

20. Recommended service intervals 83
 Warranty Regulations.....83
 Recommended replacement intervals for wear-and-tear parts85

21. Recommended tools..... 86

22. Recommended spare parts Speedy - Starter Kit 87

1. Main components of the Speedy laser engraver

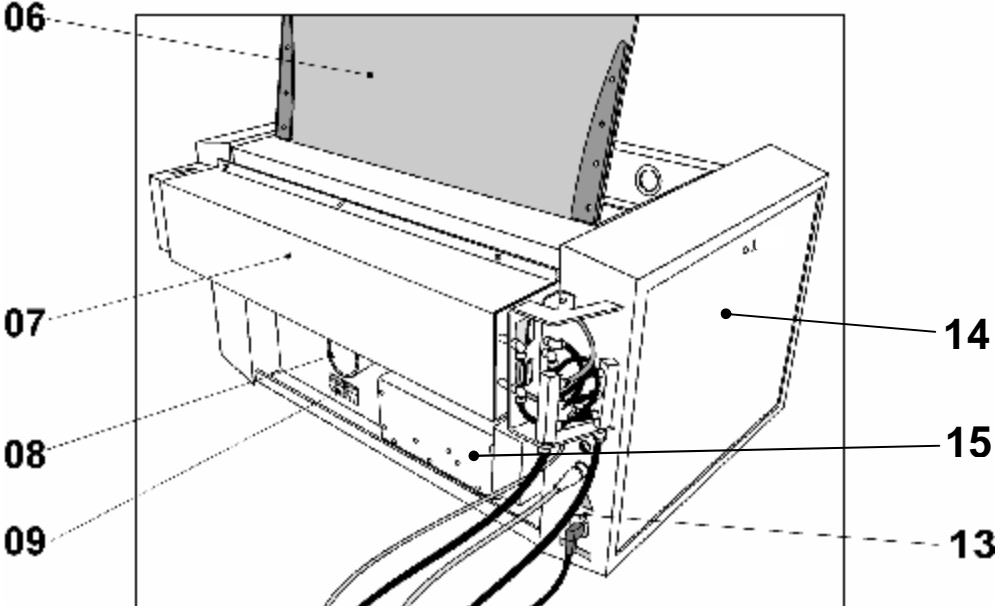
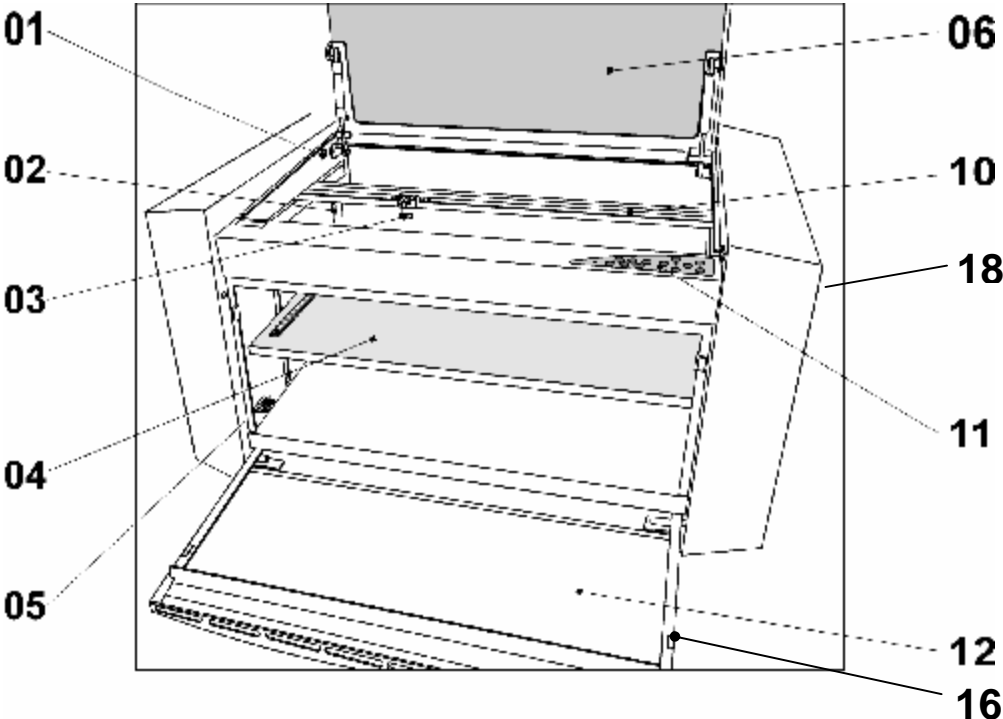

INDIVIDUAL MARKING SYSTEMS

1	service socket	15	Power supply
2	autofocus sensor	10	X-axis
3	focussing head	11	keypad
4	engraving table	12	front lid
5	Y-axis connector	13	power socket
6	Polycarbonate door	14	service access panel
7	Laser tube cover	16	right interlock front lid
8	Exhaust connector	18	maintenance panel
9	Product ID label		

2. Safety information

Please read this chapter **before** operating or servicing a Speedy laser system!

General

The Speedy is an industrial apparatus with a high level of security. To guarantee a safe operation it is necessary to know potential dangers and avoid risks. The dangers can be classified in three categories:

- ì Dangers caused by the laser beam
- ì Dangers caused by electricity
- ì mechanical dangers

General Safety Instructions

When working with the laser engraver please take note of the following safety instructions:

1. Operation and service of the Speedy may only be performed by trained personnel.
2. Direct exposure of skin or eyes to laser radiation may cause severe injuries. The correct operation and service according to the manual can prevent hazards. Operators may perform procedures required inside the housing only through the interlocked door. They must never attempt to defeat the door interlocks nor remove non interlocked portions of the housing.
3. The laser beam can ignite flammable materials. Therefore a fire extinguisher should always be nearby. Do not store flammable materials near or inside the laser engraver.

Working with the laser or setting the system to service mode without supervision is not permitted.

4. Many materials, especially non-anodized aluminium, copper, silver and gold, cannot be engraved with the laser engraver due to the very low absorption of laser radiation. This means that most of the energy of the laser beam is reflected. Therefore those materials must not be present in the laser beam path as otherwise a reflected laser beam could destroy the cover of the laser unit.
5. Beam adjustment may only be done by trained personnel. Otherwise there could be uncontrolled emission of laser radiation. There are only limited possibilities to adjust the mirrors due to a mechanic restriction. These restrictions may only be altered by authorized personnel.
6. Before starting to work check whether the engraving of the material can cause harmful fumes and whether the filters of your exhaust system are suitable for these fumes. It is emphasized that it is the user's responsibility to obey the national and regional threshold values for dusts, fumes and gases. (The maximum concentration of harmful substances must not be exceeded). Never use the laser engraver without an exhaust unit with appropriate filters for the treated material, as cutting or engraving certain materials can produce vapours. Materials causing toxic or carcinogenic smokes or fumes must not be treated without an exhaust unit with appropriate filters. Furthermore it is the user's responsibility to ensure the safe removal and disposal of the smokes and particles from the laser machine according to the national and regional threshold values. In the US reference should be made to Section 7.3 in the ANSI Z136.1 - 1993 Standard for the safe use of lasers, to the exposure criteria in CFR 1910 Subpart Z from the US government, and to the Threshold Limit Values (TLVs) published by the American Conference of Governmental Industrial Hygienists (ACGIH).
7. Please refer to the manual of your exhaust system regarding the change intervals of the filters. We recommend to make a note of the last change of filters on an adhesive label.
8. PVC (Polyvinylchloride) must not be processed with the laser engraver.

If you have any questions please contact your supplier or Trotec.

Laser Safety

The safety of a laser apparatus is defined by one of five safety classes: I (1), II (2), IIIa (3a), IIIb (3b) and IV (4). The Speedy without laser pointer is in the EU safety class 1 (with an installed laser pointer laser class 2) and therefore presents no hazard to personnel when properly used during normal operation or routine maintenance. In the US all machines are classified as class II laser products. This status is guaranteed by the safety housing and safety devices that are built into the product.

Please be aware that improper operation of the laser apparatus nullifies this safety class and allows under certain circumstances the emission of radiation which can be potentially dangerous.

This laser engraving system contains a carbon dioxide (CO₂)-laser class IV (4) product, which emits an ***intensive*** and ***invisible*** radiation. Without safety devices the direct radiation and also diffuse reflected radiation is dangerous.

Please be aware:

The Laser Radiation of a CO₂ Laser is Invisible!

US laser classes

As posted by the Center for Devices and Radiological Health (CDRH) regulation 21 CFR 1040.10 and 21 CFR 1040.11, the standard classification for lasers are as follows:

Class I laser product

No known biological hazard. The light is shielded from any possible viewing by a person and the laser system is interlocked to prevent the laser from being on when exposed. (large laser printers such as the DEC LPS-40 has a 10mW HeNe driving it which is a Class IIIb laser, but the printer is interlocked so as to prevent any contact with the exposed laser beam, hence the device produces no known biological hazard, even though the actual laser is Class IIIb. This would also apply to CD players and small laser printers, as they are Class I devices).

Class II laser products

Power up to 1 milliwatt. These lasers are not considered a optically dangerous device as the eye reflex will prevent any ocular damage. (I.E. when the eye is hit with a bright light, the eye lid will automatically blink or the person will turn their head so as to remove the bright light. This is called the reflex action or time. Class II lasers won't cause eye damage in this time period. Still, one wouldn't want to look at it for an extended period of time.) Caution labels (yellow) should be placed on the laser equipment. No known skin exposure hazard exist and no fire hazard exist.

Class IIIa laser products

Power output between 1 milliwatt and 5 milliwatt. These lasers can produce spot blindness under the right conditions and other possible eye injuries. Products that have a Class IIIa laser should have a laser emission indicator to tell when the laser is in operation. They should also have a

Danger label and output aperture label attached to the laser and/or equipment. A key operated power switch SHOULD be used to prevent unauthorized use. No known skin hazard or fire hazard exist.

Class IIIb laser products

Power output from 5 milliwatts to 500 milliwatts. These lasers are considered a definite eye hazard, particularly at the higher power levels, which WILL cause eye damage. These lasers MUST have a key switch to prevent unauthorized use, a laser emission indicator, a 3 to 5 second time delay after power is applied to allow the operator to move away from the beam path and a mechanical shutter to turn the beam off during use. Skin may be burned at the higher levels of power output as well as the flash point of some materials which could catch fire. (I have seen 250mW argons set a piece of red paper on fire in less than 2 seconds exposure time !) A red DANGER label and aperture label MUST be affixed to the laser.

Class IV laser products

Power output >500 milliwatts. These CAN and WILL cause eye damage. The Class IV range CAN and WILL cause materials to burn on contact as well as skin and clothing to burn. These laser systems MUST have:

A key lockout switch to prevent unauthorized use Inter-locks to prevent the system from being used with the protective covers off Emission indicators to show that the laser is in use Mechanical shutters to block the beam Red DANGER labels and aperture labels affixed to the laser The reflected beam should be considered as dangerous as the primary beam. (again, I have seen a 1,000 watt CO2 laser blast a hole through a piece of steel, so imagine what it would do to your eye !)

Registration of laser systems

Any laser system that has a power output of greater than 5 milliwatts MUST be registered with the FDA and Center for Devices and Radiological Health if it has an exposed beam, such as for entertainment (I.E. Laser light shows) or for medical use (such as surgery) where someone other than the operator may come in contact with it. (this is called a 'variance' and I have filled them out and submitted them and they ARE a royal pain in the backside !)

Risks of Laser Radiation:

If the built in safety measures are defeated or the laser is operated with the housing open, there is a risk of setting clothing or other flammable materials on fire. Laser energy at a power of up to 150W (Model C100) at a wavelength of 10,6 μm could be present inside the housing.

Therefore operators can perform procedures required inside the housing only when the interlocked door has been opened. (A normal user must never defeat the door interlocks or remove portions of the protective housing, except the machine is not powered).

Therefore you must under no circumstances neither alter the laser tube unit nor dismantle it nor set a system to work which has been altered or dismantled!

Safety Interlock System

Your Speedy is equipped with an integrated safety interlock system which cuts off the power of the laser tube immediately as soon as one of the doors is open ed.



CAUTION

Do not attempt to alter the interlock system as that could result in hazardous radiation exposure.



CAUTION

Technicians who are performing service procedures must be trained in laser safety, and if they are defeating interlocks, they must wear laser protective eyewear designed for the 10,6µm CO₂ laser energy.

The top door, front door and the maintenance access panel are interlocked. If the interlocks are defeated access to laser class IV radiation is possible through any of these doors.

All other covers are not interlocked.



CAUTION

When a non interlocked cover is opened (and the machine is powered) access to class IV laser radiation is possible.

These covers are labeled with „DANGER: INVISIBLE LASER RADIATION WHEN OPEN. AVOID EYE OR SKIN EXPOSURE TO DIRECT OR SCATTERED RADIATION“

Dangers of Electricity

When you open the covers of the engraving system there is the danger to get in contact with parts under high voltage. Therefore it is absolutely necessary that service and repair work is only done while the power supply is unplugged. In any case all safety laws and standards in connection with electricity must be obeyed.

IMPORTANT REMARK:

Usually you do not need to get in touch with the electrical and electronic components. In case you do that when servicing or repairing the laser engraver, please be sure that you first plug off the power supply.

Emission indication and safety labeling

Light Emitting Diodes

On the keypad of the laser engraver there is on the left side a red LED (light emitting diode) which is illuminated when laser radiation is emitted.

If the service plug is used to defeat the door interlocks, the red LED close to the service button is flashing (which indicates that the machine now is in service mode). In this case the machine represents a laser class IV (4) product and special safety provisions are necessary.

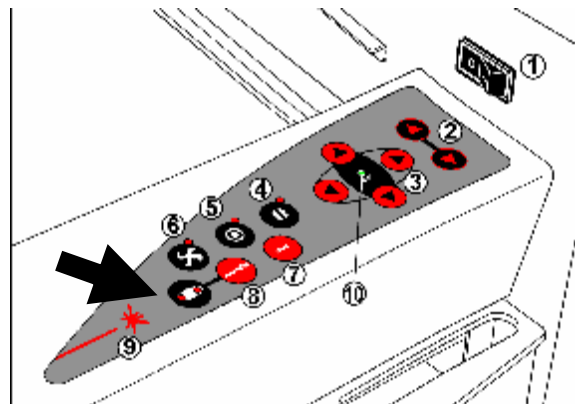

emission indicator

Audible Warning

When starting up the laser engraver without closing the cover there is an intermittent beep. This indicates that the interlock system has not been checked yet. (You can run the machine only if all interlock switches are closed). Close the cover of the laser engraver to cause the machine to initialize.

On emitting a laser beam (which is called test pulse) by pressing the „TEST“ - and "SERVICE" button simultaneously there is a beep (as long as you keep the buttons pressed) to remind you of the possible risks.

Safety Labels

The laser safety standards require that any removable panels that could permit access to laser energy include laser safety labels. These labels are visible before and after opening a cover.

Labels with the name of the manufacturer, date of production, description of the product, model number, serial number and safety labels are placed on the outer side of the apparatus. All these labels are mounted when producing the laser engraver. These labels must not be removed.

If the labels are lost or damaged please contact Trotec. Replacements will be sent to you free of charge. All labels and their exact place is mentioned in the user manual: The labeling meets the standards

F 21 CFR 1040 – Laser safety

and

F EN 60825-1(1994)

3. Laser beam alignment on Speedy

What you need:

laser protection glasses (for CO₂ lasers)
the toolbox enclosed to your engraver
masking tape



CAUTION To make sure that there is no laser emission out of a controlled area establish a limited access area by using non flammable beam blocking curtains, temporary walls or other enclosures.



CAUTION The laser beam alignment may only be performed by service technicians that have been trained by Trotec and are familiar with the hazards from lasers



CAUTION
Never expose any part of your body to the beam as this could result in serious injuries.



CAUTION
To do the alignment it is absolutely necessary to wear laser protection glasses.

What you have to know:

The number of the mirrors is counted from the outlet of the laser tube to the engraving head from one to three.

The whole alignment is done while your machine is running. To make sure the system works at a suitable power level switch your machine off and on again.

The laser beam is invisible. To make it visible, you use adhesive tape. It is burned at the spot, where it is hit by the laser beam and shows so a mark.

The tolerable displacement (distance from burned dot to the centre) is one sixth of the diameter of the mirror or hole where you check the position.

Beam path of the Speedy:

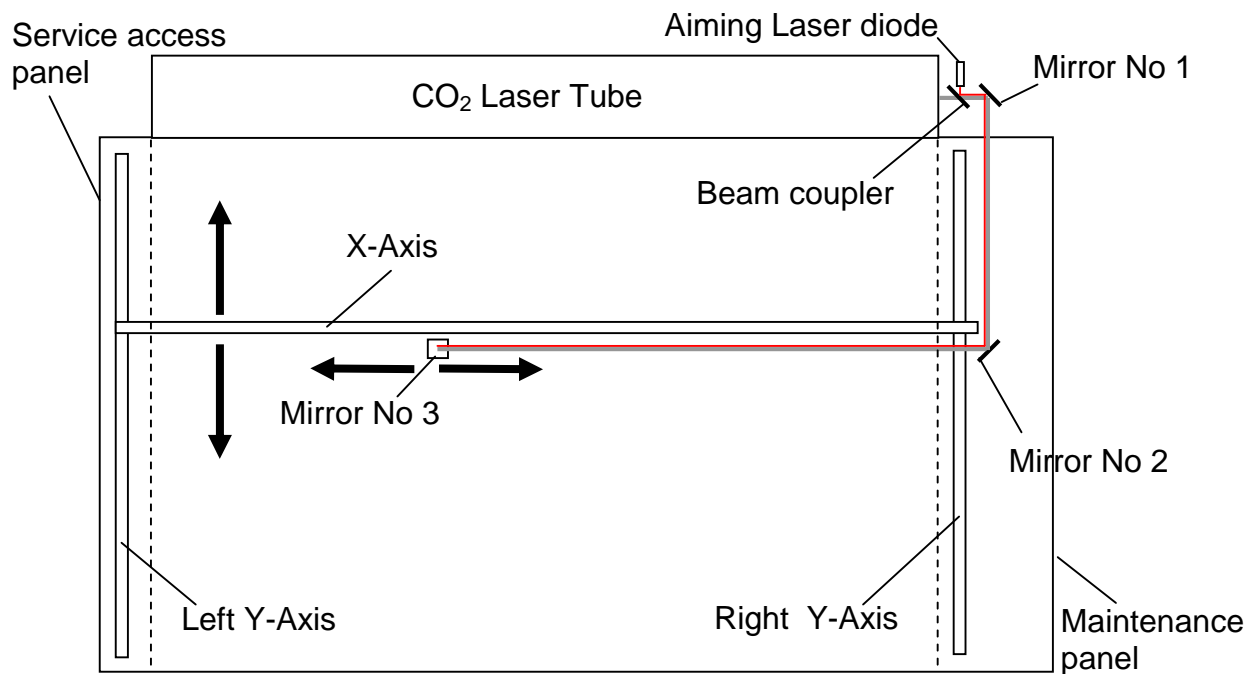

Beam path of the Speedy model

What you have to do:

1. Disassemble the cover on the right side of the machine (10mm allen key).
2. Take your laser protection glasses and remove the grey cover of the first mirror at the rear of your laser (right side) wearing the sign „DANGER. INVISIBLE LASER RADIATION WHEN OPEN. AVOID EYE OR SKIN EXPOSURE TO DIRECT OR SCATTERED RADIATION.“
3. Remove mirrors #2 and #3.

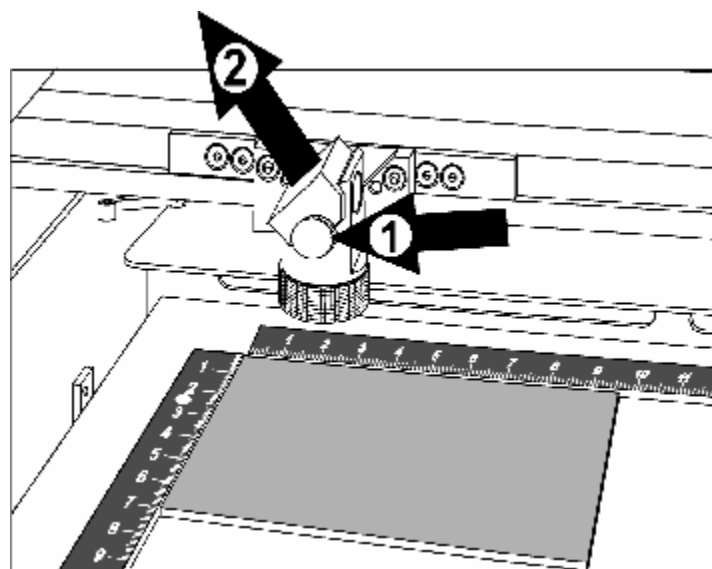
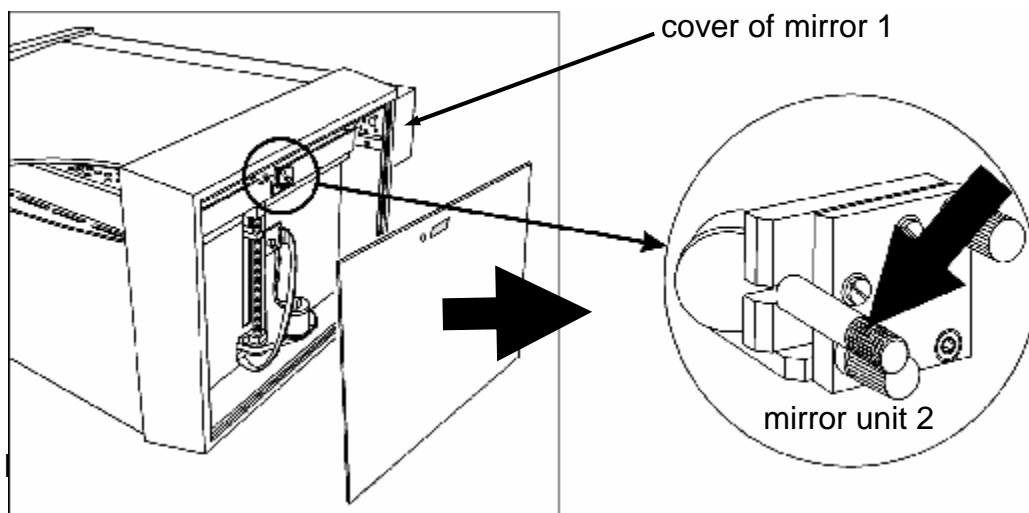

mirror unit 3

- Put a piece of masking tape on the hole (black anodized aluminium part) in front of mirror #2.

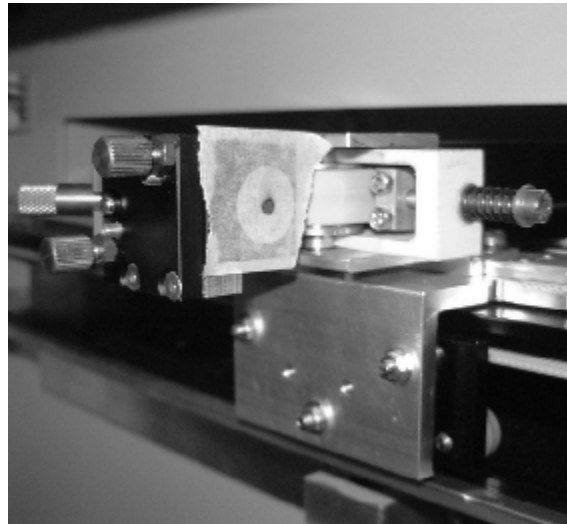

alignment of mirror no.1

- Move the x-axis to the top position.
- Press the test button, keep it pressed and then press the service button until you see a little mark on the adhesive tape. (This is only possible if all doors are closed or a service plug is put into the socket). The mark should be in the centre of the hole. (If you don't see a mark adjust the two brass screws at mirror #1 until you can see a mark.

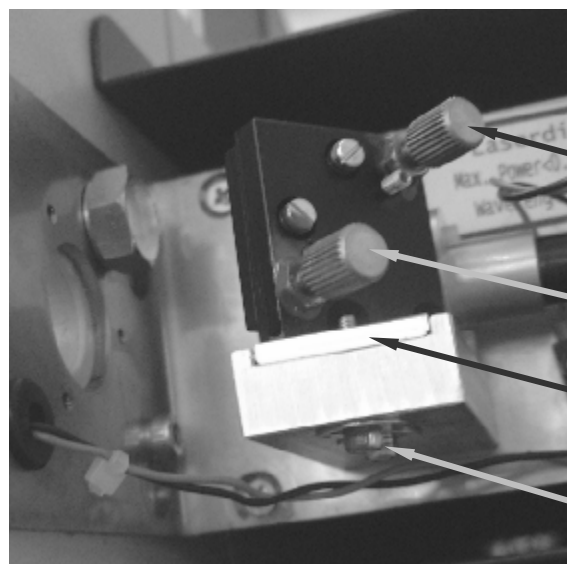

height adjustment
screw

left-right
adjustment screw

slider

slider fixing screws

adjustments at mirror #1

- Move the x-axis to the bottom position.

8. Repeat step 6, but this time try to hit the spot that you've created first.
9. Repeat steps 5 to 8 until the two spots are exactly at the same place.
10. If the spot is not centered bring it to the center by moving the slider of mirror #1.
11. Replace mirror #2.
12. Put a piece of masking tape on the hole in front of mirror #3.

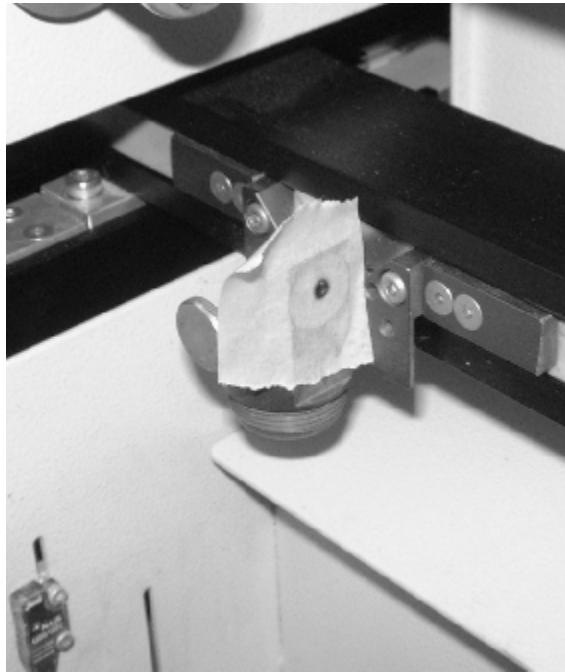

checking the beam position at mirror #3

13. Move the engraving head to the top right corner.
14. Again press the test button, keep it pressed and then press the service button until you see a little mark on the adhesive tape.
15. Move the engraving head to the top left corner and adjust the two brass screws at mirror #2 until you hit the spot created in step 14.
16. Repeat steps 13 to 15 to check the position. If necessary readjust mirror #2.
17. Move the x-axis to the bottom position and check the alignment on the bottom left position. If necessary do small corrections at mirror #1.
18. At the end check alignment on all four corners.
19. Assemble all parts again.
20. Now your engraver is aligned properly.

4. Laser pointer adjustment

Attention: To do the laser pointer adjustment it is absolutely necessary to wear laser protection glasses!

What you need:

laser protection glasses
 the toolbox enclosed to your engraver
 a philips screwdriver
 adhesive tape

What you have to know:

The alignment is done while your machine is running. To make sure the system works at a suitable power level switch your machine of and on again. The laser beam is invisible. To make it visible, you use adhesive tape. It is burned at the spot, where it is hit by the laser beam and shows so a mark. The tolerable displacement (distance from burned dot to the centre) is one sixth of the diameter of the mirror or hole where you do the adjustment.

- 1.) After you've installed the laser pointer glue some paper tape on the beam entrance hole of the engraving head (first remove the last mirror and the lens).

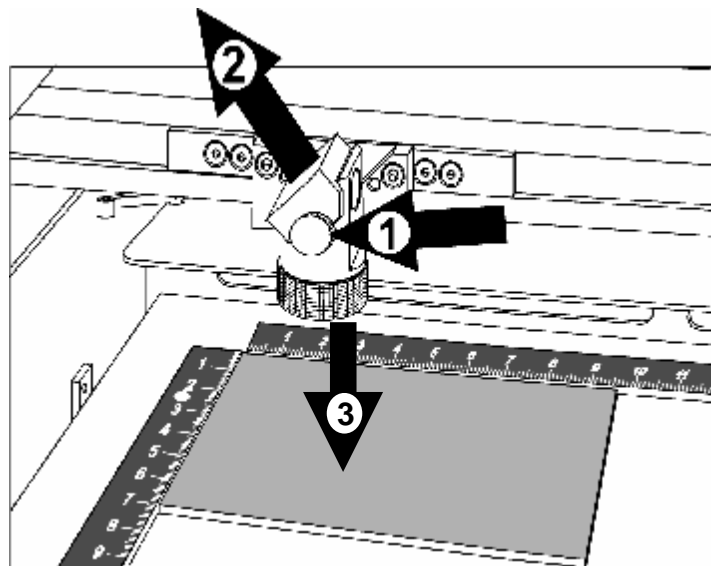

- 2.) Move the engraving head to the upper left corner of the engraving table.
- 3.) Fire the test pulse by pressing the test button, keeping it pressed and pressing at the same time the service button, until you can see a small spot on the paper tape.
- 4.) Adjust the three small screws (see attached picture) close to the laser pointer until the red dot hits exactly the burned spot on the paper tape.

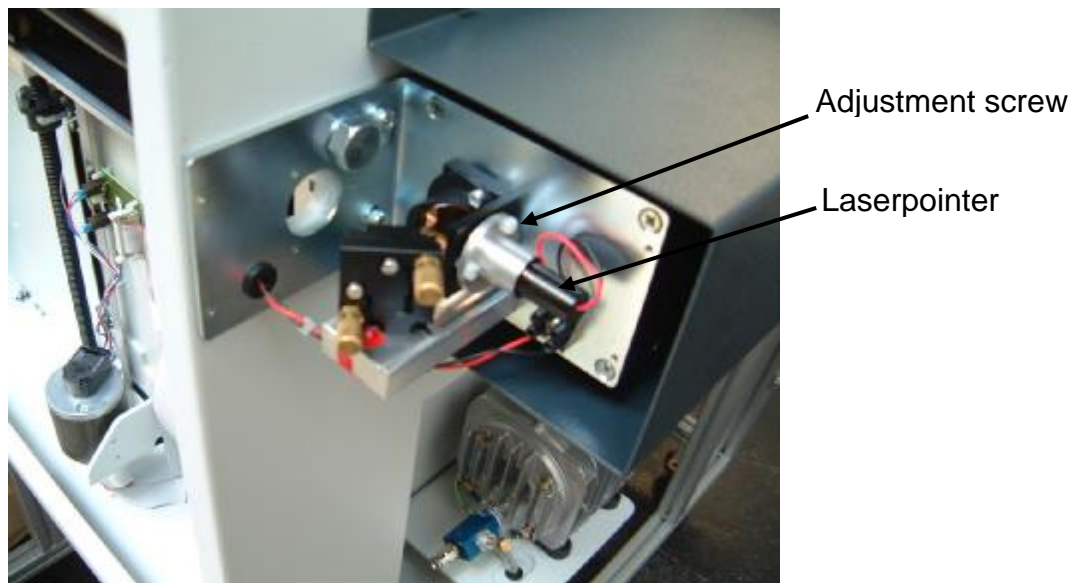

- 5.) Check the beam position on all four corners of the engraving table. You can get the highest sensitivity to changes of the pointer position in the lower left corner of the engraving table.

5. Replacing the laser tube

The laser tube is one of the main components of any laser engraver. The Speedy uses for the 12, 25, 30 and 50W version Synrad tubes, and for the 100 W version a Coherent tube. The 50 and 100W tubes are liquid cooled, all other tubes are air cooled.

To make the tube fire it must be

- *Connected to the power supply* (48V for the 100W unit, for all other machines 30V)
[On Synrad tubes this will be indicated with a green LED]
- *Provided with a control signal* (BNC connector, two for the 50W)
The control signal is a 5V TTL signal that comes from the main board.
[if there is a signal Synrad tubes will indicate this with an illuminated red LED]

Additionally on the 100W machines the coolant velocity must be above 5.7 l/min.

All tubes have an integrated overtemperature protection. If the tube exceeds a certain limit it is switched off to prevent a damage of the gas/electronics.

The following reasons might cause you to replace the tube:

- A too low laser power
- Fluctuations of laser power (typically jumps from 100% to 50% engraving depth on a 25W unit, or from 100% to 75% on a 50W machine)
The frequency of these power fluctuations is low (e.g. every 5 minutes)
- Uncontrollable timing behaviour (high frequency effect).
This effect shows shifted start/end points of the pulses so that the image looks frayed although the mechanics (of the motion system) and software adjustment are OK.

Measuring the laser power:

To measure the laser power you need:

1. Laser protective goggles
2. Laser power meter
3. Interlock defeat tool



tools for measuring the laser power



CAUTION To make sure that there is no laser emission out of a controlled area establish a limited access area by using non flammable beam blocking curtains, temporary walls or other enclosures.



CAUTION The laser power measurement may only be performed by service technicians that have been trained by Trotec and are familiar with the hazards from lasers



CAUTION
Never expose any part of your body to the beam as this could result in serious injuries.



CAUTION
To do the laser power measurement it is absolutely necessary to wear laser protection glasses.

- Open the Trotec manager and connect to the engraver
- Enter the Advanced Options menu (Settings>Advanced options, Tab Testpulse) and switch Power Testpulse to 100%. Press update.

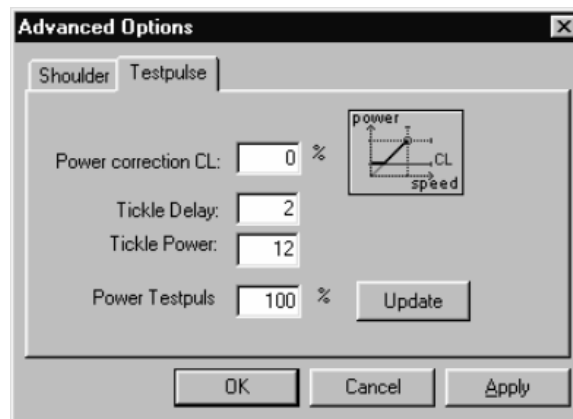

increasing the test pulse to full power

- Defeat the interlock by plugging the interlock defeat tool into the socket on the left side of the engraving area.
- Remove the lens
- Put the power meter with the black absorbing area in one of the corners of the engraving table
- Move the table to a height level so that the distance between engraving head and target area is approximately four centimetres.

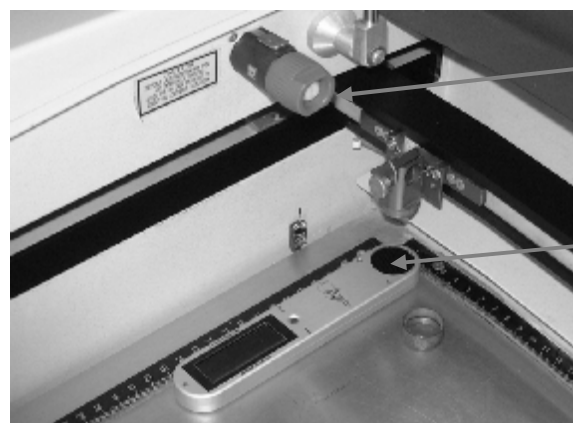

setup for measuring the laser power

- Press the reset button on the power meter and fire the testpulse (press test, keep it pressed and then press service)
- After some seconds you will hear a beep sound, which indicates that the measurement has been finished.
- Repeat the procedure in the other corners

The wattage difference between the four corners should be smaller than 10% of the average laser power. Otherwise something is wrong with the beam alignment. In this case measure the power directly at the beam aperture.

Laser tube replacement (12W and 25W)

1. Switch off the Speedy and open the service access panel using a 10 mm allen key. Remove also the cover of the electronic compartment.
2. Unplug the power connector (black-red) for the lasertube on the main board.



connectors on the power board

3. Remove the protective cover of the cooling fans.

4. Take out the metal grid and disconnect the cooling fans.

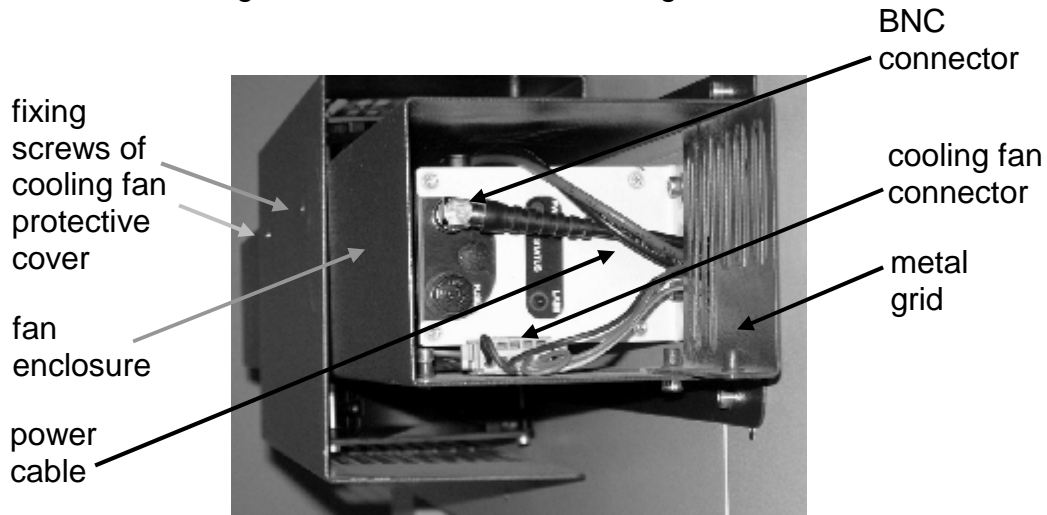

Pull out the black-red power cable.

5. Remove the fan enclosure
6. Pull out the power cable (black-red) and unplug the signal cable on the lasertube.
7. **CAUTION:** Before you perform that step please ask a second person to assist you. The risk here is to drop the tube. Loosen the two 4mm screws on the right side of the tube and remove the four philips screws on the left side (before you can do that remove the cover of mirror unit 1).
8. Remove the tube
9. Assemble the new tube in the reverse way.
10. After the replacement you've to do the beam alignment.

Laser tube replacement (50W and 100W)

1. Switch off the Speedy and open the service access panel using a 10 mm allen key. Remove also the cover of the electronic compartment.
2. Unplug the power connector (black-red) for the lasertube on the main board.
3. Remove the tube enclosure.
4. Disconnect the six push fit fittings that are connected to the tube and disassemble the two that fix the plastic water distributor.
5. Remove also all fittings on the left side of the tube.
6. Pull out the power cable (black-red) and unplug the two signal cables on the lasertube.
7. **CAUTION:** Before you perform that step please ask a second person to assist you. The risk here is to drop the tube. Loosen the two 4mm screws on the right

side of the tube and remove the six philips screws on the left side (before you can do that remove the cover of mirror unit 1).

8. Remove the tube
9. Assemble the new tube in the reverse way.
10. After the replacement you´ve to do the beam alignment.
11. Pack the tube and ship it back to Trotec.

6. Adjusting the Software

Adjusting the tickle power

The tickle pulses are used to keep the plasma inside the tube ionized continuously. This guarantees a quick response whenever laser power is needed to mark or cut materials.

If the tickle power is too low, then typical effects are bad contrast for fine details, missing elements (e.g. a not closed circle) or frayed edges.

If the tickle power is too high you will see shadows on the edges.

There are two settings in the Trotec manager, which are responsible for a correct excitement of the gas filling. These are:

1. Tickle power
2. Tickle delay

Tickle delay is a setting that should be left at it's default value of 30. It defines a time from the end of laser output (to mark the surface) to the start of the tickle pulses within which no tickles are sent. This delay makes sure that no following pulses are caused by the tickles immediately after firing.

Tickle power is a parameter that defines the intensity of the tickle pulses.

Reduce it when you see shadows on the edges.

Increase it, when e.g. fine images on anodized aluminium are darker than big ones.

To find the correct settings of tickle power do the following steps:

1. Warm up the tube by engraving some rubber stamps at full power.
2. Take a very laser sensitive material e.g. laser plastics or soft wood.
3. Reduce the acceleration of the X-axis (settings>options>service:password „name“) to 1.
4. Engrave an image (please use the sample file „Abnahmetest Alu“ on the CD in the folder Samples\QS Spoolfiles [copy it into the Spool directory and alter the file properties from „read only“ to „archive“]) into the wood and have a look on the edges (please use a low speed).
5. If you see shadows reduce tickle power, if there are none increase tickle power. To make sure that your changes take effect always click on apply in the dialog window.



shadows beside the engraving, caused by too high tickle power

6. Repeat steps 4 to 6 until you´ve found the setting that is necessary to prevent shadows, but keeps the tube just below firing.
7. Now you´ve adjusted tickle power.

Note: Before you adjust the edit settings of a tube you should always make sure that tickle power has been set correctly.

For optimum engraving quality a new adjustment of Edit settings and tickle power is necessary after a certain lifetime of the tube (Recommended after 1000 hours of operation).

Adjusting the Power Correction factor CL:

The factor CL (menu settings>advanced options>Tab Testpulse) is a minimum power that will affect the material even when the engraving speed is zero. The reason why we need a power correction is in the material behavior itself: Many materials show a nonlinear response. That means when you engrave on the material with a continuously increased power level the change of color will not have a linear connection with the change of power. For many materials you need a certain minimum power level that is necessary (e.g. anodized aluminium: because of the high heat conductivity, that causes a quick heat transfer you need a relatively high factor $CL \approx 30$) for marking the workpiece. This minimum power can be adjusted by setting the power correction factor CL.

Note: The power correction factor must be adjusted for each material individually and can be changed only in the Trotec manager. For most materials a low value of $CL \approx 0..3$ is OK)

Steps for adjusting the power correction:

1. Create a rectangular cut job ($\approx 5 \times 5\text{cm}$)
2. Vector into the material. Set the parameters so that you only mark the surface and do not cut deep into the material.
3. If the cut line is closed on the corners but is thicker where the lines meet reduce CL.

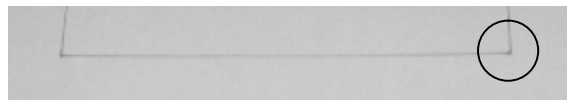

4. If the cut line is not closed on the corners increase CL.



5. As soon as you have a closed curve with constant line thickness you've found the correct factor of CL.

Note: This adjustment is only necessary when you want to mark only the surface of a material. It is not needed for Lasercutting all the way through the material. A change of the tickle power setting will also affect the correct setting of CL.

Adjusting the Offset parameters:

The Speedy uses so called offset parameters (X and Y) to make sure that the zero position of the software is exactly in the crosspoint of the rulers. This is important for precise positioning of jobs.

Additionally we use the Z offset to finetune the automatic focus. (only for focussing using the software)



Tab „Offset“ in the Service menu

An offset is a certain distance from the home position that is given by the limit switches to the edge of the rulers (for X and Y) or the focus level of the lens (Z).

Whenever you see that the position of your engraving on the table is not the same as in your desktop publishing program you have to adjust the offsets.

Steps for adjusting the X and Y offsets:

1. Make sure that the ruler angle has been adjusted correctly.
2. Focus your beam on the surface of the rulers and glue some paper tape in the crosspoint.
3. Move the engraving head to 0/0 (Engraver>move laser)
4. Fire the test pulse until you can see a small spot in the paper tape.

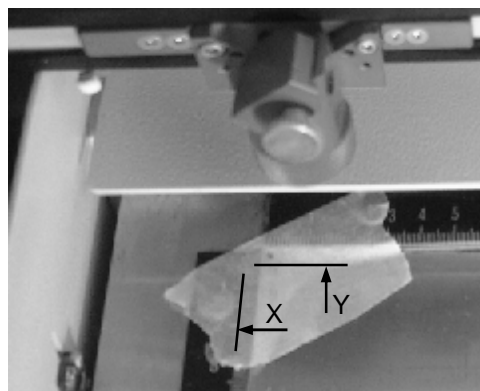

checking the zero position

5. The distance between this spot and the rulers should be smaller than 0.5mm.
6. If the distance is bigger: between X ruler and spot \Rightarrow reduce X-offset until you are within tolerance (Settings>Service settings [password „name“]>tab Offset), between Y ruler and spot \Rightarrow reduce Y-offset.
7. If you hit into the ruler(s): Y \Rightarrow increase the X offset, X \Rightarrow increase the Y offset.

Note: If you can not reach the necessary position you have to move the rulers. Please refer to the „ruler adjustment“ in this manual.

Steps for adjusting the Z offset:

1. Check if the table has been adjusted correctly.
2. Make sure that the selected plate material has been defined as 0mm thick.
3. Move the engraving head to 100/100 mm (Engraver>Move laser)
4. Hang the focus tool on the engraving head.
5. Click on „focus laser“ or select Engraver>Focus laser (top door must be closed).
6. The focus tool should gently touch the table.
7. If it drops increase the Z offset, if there is space between the tip and the engraving table decrease the offset.

Note: If it is not possible to reach a satisfying result (because there is not enough range of adjustment) you have to move the limit switches (especially the lower one, as this is used for homing)

Overtook adjustment:

The Trotec manager shows a special feature that is used to fine tune the engraving quality of the machine. For a variety of speeds you can set individual parameters (so called edits) to compensate the dynamic behavior of the tube. Using these factors we can compensate a tube behavior that is different from the average.

Typical symptoms of an incorrect Edit factor adjustment are:

- Double letters for small fonts
- Inconstant line thickness for horizontal and vertical lines
- Frayed edges

If you see one of these effects you have to alter the Edit settings in your Trotec manager.

Understanding the Overtook table:

The table gives you the following information:

- 1st column: gives you the speed from which on the selected line is valid.
- 2nd column: gives the overtook (distance of travel from the line end to the position where the engraving head turns it's direction)
- 3rd column: Edit factor for engraving in X direction.
- 4th column: Edit factor for engraving in Y direction.



Tab „Overtook“ in the Service menu

When you for example engrave in X direction at 80% power and 25% speed (which means 50cm/s) the second line of the table is taken to figure out the edit factor.

Steps for adjusting the Edit settings:

1. Create a job at 125dpi that looks like the following:



You can use the job for adjusting the X edit when you engrave it in X direction, when you rotate it by 90° and engrave it in Y direction (which can be done directly in the manager) you can adjust the Y edits.

2. In a job like this you can see (when you engrave it) the individual lines (as they are not overlapping at 125 dpi)
3. Engrave this job at a certain speed and check the shift between the start points of the lines using a magnifier. (you can see that every line is shifted to the neighbouring one)



bad adjustment of the edit factor

4. A perfectly adjusted machine doesn't show a shift between the individual start points.
5. If there is a shift increase or decrease the edit factor and repeat step 3 until it disappears.



the adjustment is OK now

6. Keep on adjusting until you have at any speed a perfect result.

Note: Before adjusting the Edit factors make sure that tickle power is adjusted correctly.

To rotate job and engraving direction by 90° go to the plate setup and select the opposite parameters for engraving direction and job orientation.

Tab „correction“ in the service setup

The default parameters are:

Acceleration: 5
 K1: 12
 K2: 0
 K3: 0

These paramters have been tested well and should never be touched.

Tab „acceleration“ in the service setup

The default parameters are:

X:	9
Y:	4
Vector:	1
Circle:	1

Altering the default parameters can be useful if there is a problem on one of the axis (tracking errors) and you want to keep the machine in operation. In this case reduce the acceleration (and eventually the top speed).

7. Adjusting the Hardware

Ruler adjustment and rectangularity adjustment of the motion system

The Speedy provides a far developed system of software adjustment. This makes it also possible to fine adjust the zero position of the rulers precisely without touching any mechanical component. (Please refer to the chapter software adjustment)

If a software adjustment is not possible (e.g. because the range of adjustment in the software is too small or the rulers are not parallel to the motion system) you have to adjust the rulers and/or the motion system.

How to check the ruler position

For both rulers we have a tolerance of 0.5mm to the rulers. That means that (when you fire the test pulse) the burned spot must not hit the ruler and have a distance of max. 0.5mm to the ruler. If the distance is bigger and not constant you have to adjust rulers and/or X-axis.

Y ruler check

1. Glue some adhesive tape in the crosspoint and at the endpoints of the rulers.



setup for checking the ruler positions

2. Focus on the rulers
3. Move the engraving head to 0/10 (Engraver>Move laser, X=0, Y=10)
4. Fire the test pulse into the paper until you see a small spot (press test, keep it pressed then press service)



testing the ruler positions

5. Move the engraving head to the lower end.

6. Fire the test pulse again.

X ruler check

1. Glue some adhesive tape in the crosspoint and at the endpoints of the rulers.
2. Focus on the rulers
3. Move the engraving head to 0/0 (Engraver>Move laser, X=10, Y=0)
4. Fire the test pulse into the paper until you see a small spot (press test, keep it pressed then press service)
5. Move the engraving head to the right end.
6. Fire the test pulse again.

Ruler adjustment

When you've found that the Y-axis is not parallel to the ruler (inconstant distance between the upper and lower spot and the y ruler) you've to open the three philips screws that fix the Y ruler and shift the ruler until the above mentioned axis check shows a result that is within tolerance.

After you've done that make sure that the X ruler is oriented in an angle of exactly 90° to the Y ruler. If it is not, please open the five Philips screws that fix it and rotate the ruler until you reach the correct angle. In the next step you've to make sure that the X axis is parallel to the X ruler. If the X ruler check fails adjust the angle position of the axis.

Rectangularity adjustment of the motion system

1. Please open the three screws on the right and the two on the left side of the X axis, that connect it to the sliders.

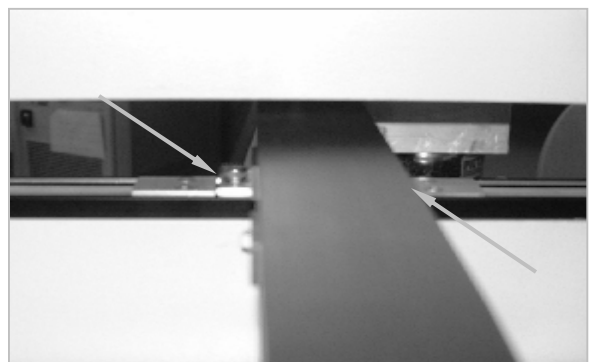
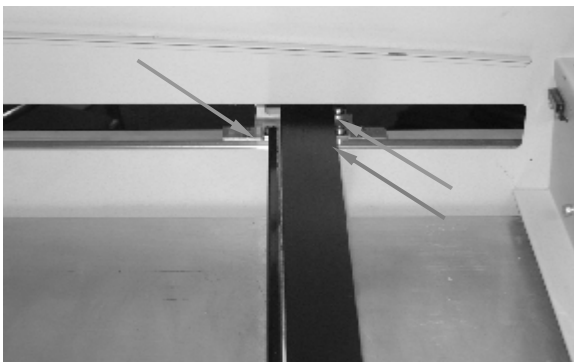

fixing screws on the right and on the left side of the X-axis

2. Open the Y axis drive shaft connector (in the maintenance compartment)

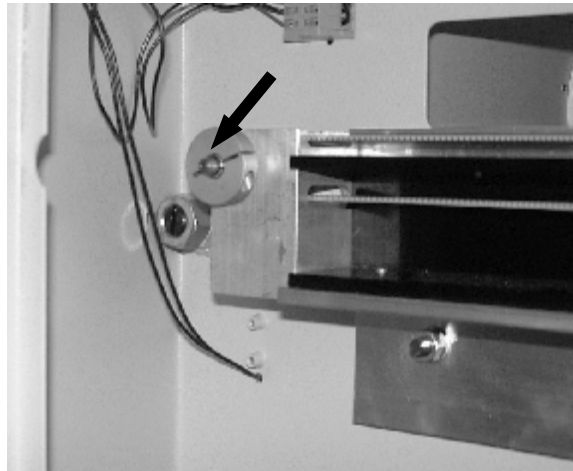

Y axis drive shaft connector

3. Perform the ruler check as mentioned above, but do not use „move laser“ to reach 0/0, do this manually by pressing the arrow keys.
4. Turn the (right side of the) X axis if necessary, until the axis position is within tolerance.

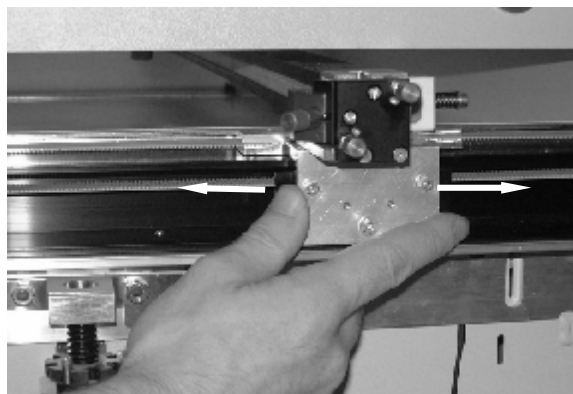

adjusting the angle position

5. Fix drive shaft connector and holding screws again.

Caution: When you rotate the ruler it can easily happen that the laser beam is no longer centered at the engraving head. To make sure that this effect does not affect the adjustment result check also the beam position at the engraving head regularly.

Table adjustment

The correct adjustment of the table is important to make sure that a constant engraving depth is reached all over the table (another reason for an inconstant engraving depth is a bad beam alignment).

How to check the table adjustment:

1. Focus on the table.
2. Move the engraving head to the position X/Y=10/60.
3. Measure the distance between engraving head and table.

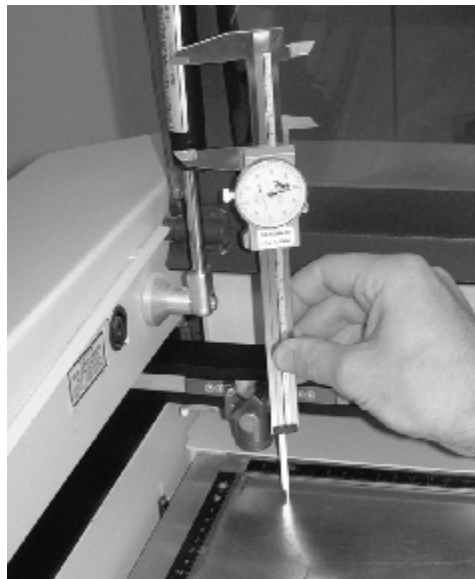

distance measurement

4. Move to 10/350, repeat step 3.
5. Move to 725/220, repeat step 3.

The accepted tolerance is 0.5 mm.

If the difference is bigger the table needs to be adjusted.

Adjusting the table

1. Focus on the table
2. Switch off the machine and disconnect it from the electric supply network.
3. Open the Maintenance access panel and the Service access panel as well as the cover of the electronic compartment.
4. Open the four screws that fix the electronic compartment

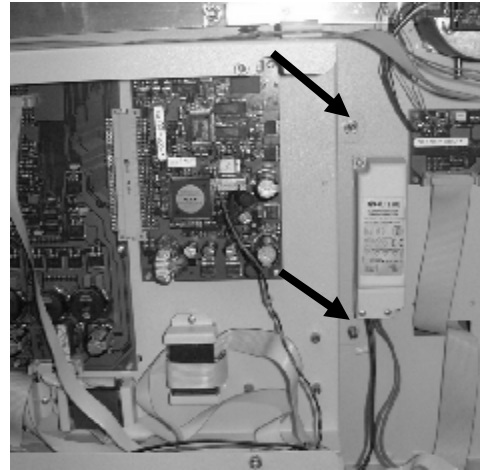
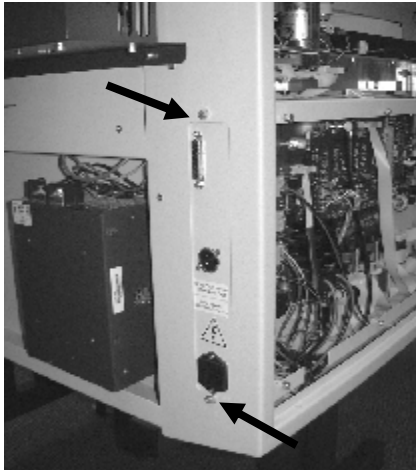

fixing screws of the electronic compartment

and move it carefully out of the housing to have free access to the lead screws and plastic nuts.

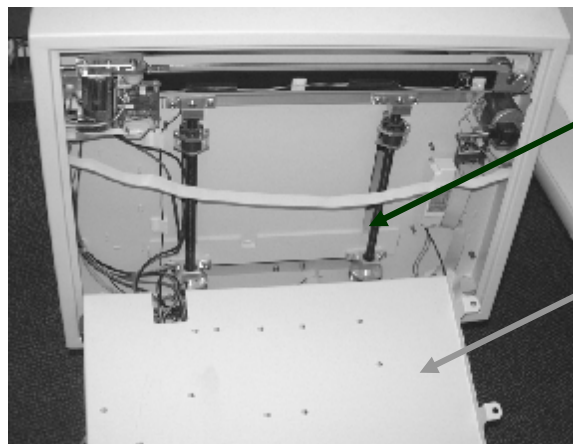

lead screw

electronic compartment

removed electronic compartment

5. Take out the screws that hold the upper lead screw nuts in their position and lift the upper lead screw nuts by 10mm.

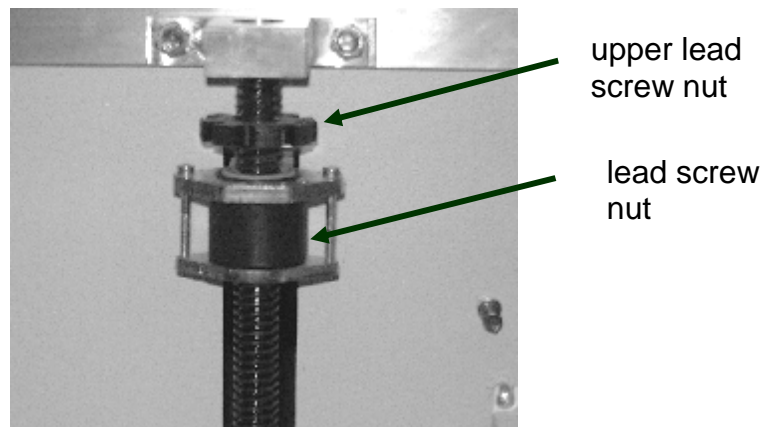

6. Move the engraving head manually to 725/220 and focus on the table.
7. Measure the distance to the table.
8. Open the lead screw nut fixing rings.

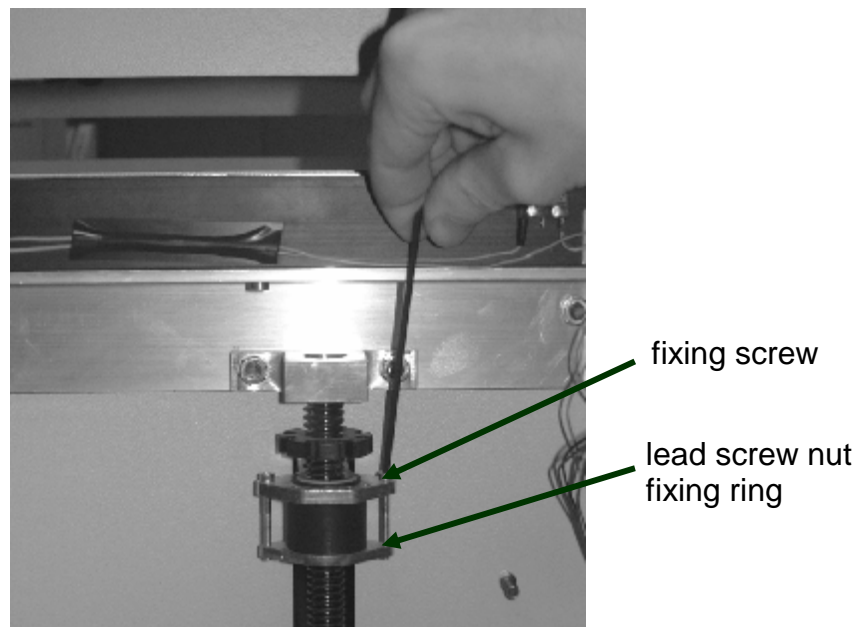

9. Now move the engraving head to 10/60 and rotate the lead screw nut close to the engraving head until you reach the correct height level of the table.

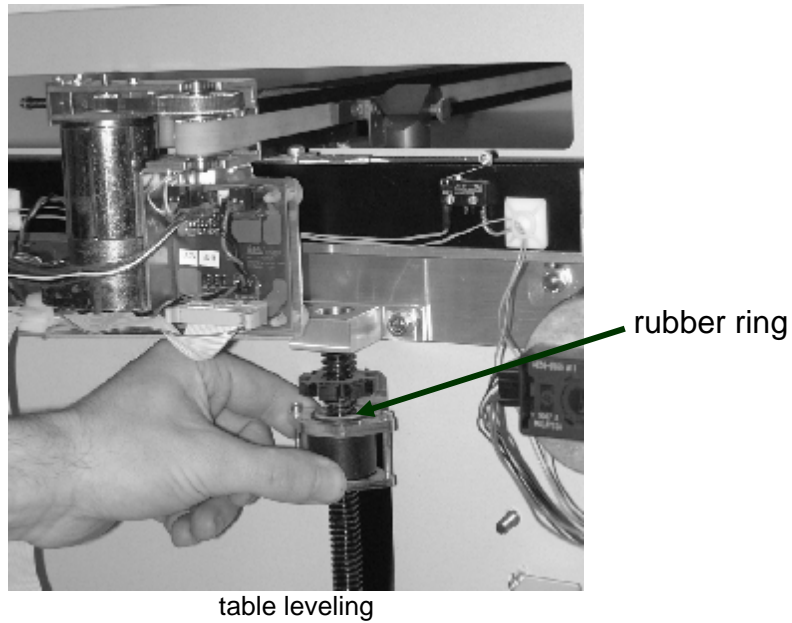

10. Do the same at 10/350.
11. For fine tuning repeat the steps 7 to 10.
12. Now tighten the lead screw nut fixing rings again.
13. Compress the rubber rings (on later versions the steel springs) by rotating the upper lead screw nuts until you feel that there is enough compression, then fix their position.
14. Assemble back all remaining components.

8. Servicing the X axis

The axes are the most strained mechanical components in a laser engraver. As we have to make sure that the precision is high enough to get a perfect engraving result it is important that possible positioning errors between incremental resolver and engraving head are minimized (engraving accuracy at $1000\text{dpi}=25.4\mu\text{m}$, at cutting $1\text{ increment}=10\mu\text{m}$).

To assure this, we have to service the axes periodically. The most important one is the X-axis, as it moves approximately 500 times farther than the Y axis (this is true for square jobs and a resolution of 500 dpi)

Each of the axes contains some parts of consumption. These are:

- Belts (motor belt and main belt)
- X-motor including drive gear
- Ball bearings
- THK guide
- X-gearing assembly

which have to be replaced regularly.

The following instruction contains all mechanical elements that might have to be replaced. On every machine the technician has to decide which of the components really has to be replaced. (For a smaller service replace only: belts and ball bearings)

Steps for servicing the X-axis:

1. Take the X-axis out of the machine
 - Loosen the two screws on the left and on the right side of the engraving head

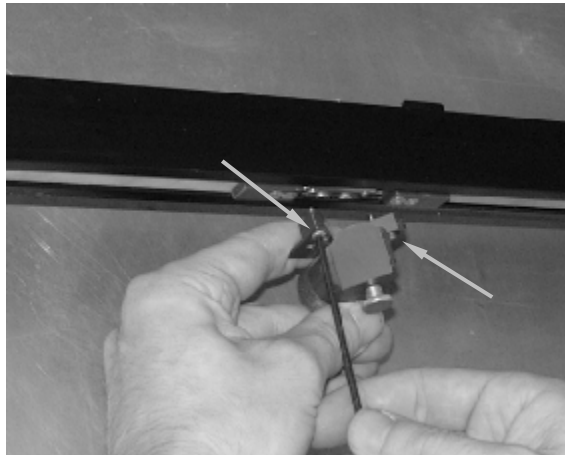

dismantle the engraving head

- Take off the engraving head
- Open the maintenance and the service access panel. Take off the cover of the electronic compartment
- Disconnect the X axis motor cable

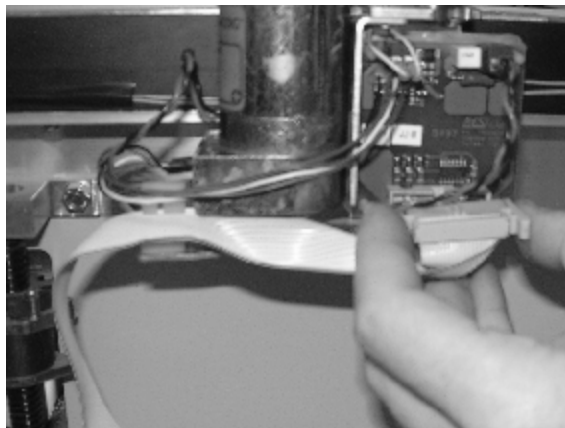

- Open the five screws that connect X and Y axis (two on the left and three on the right side of the machine)

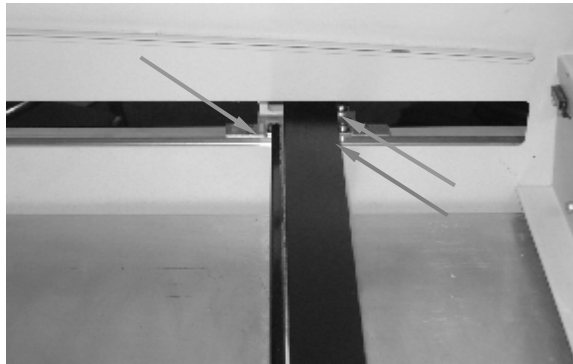

connecting screws on the right....



... and left side of the machine

- Pull out the X axis to the left

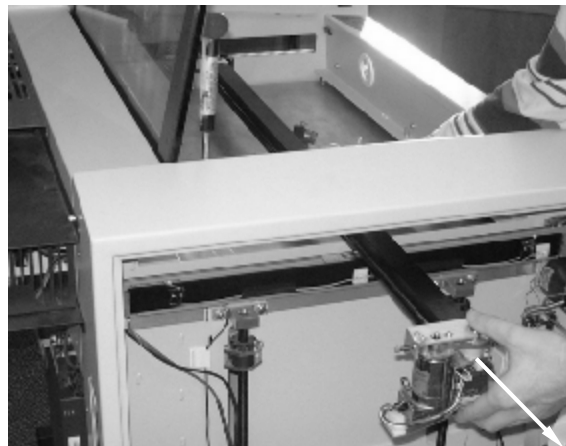

2. Dismantle the X-motor

- Disconnect DC power and resolver plug
- Loosen the two motor fixing screws
- Take out the tensioning bolt
- Take out the motor

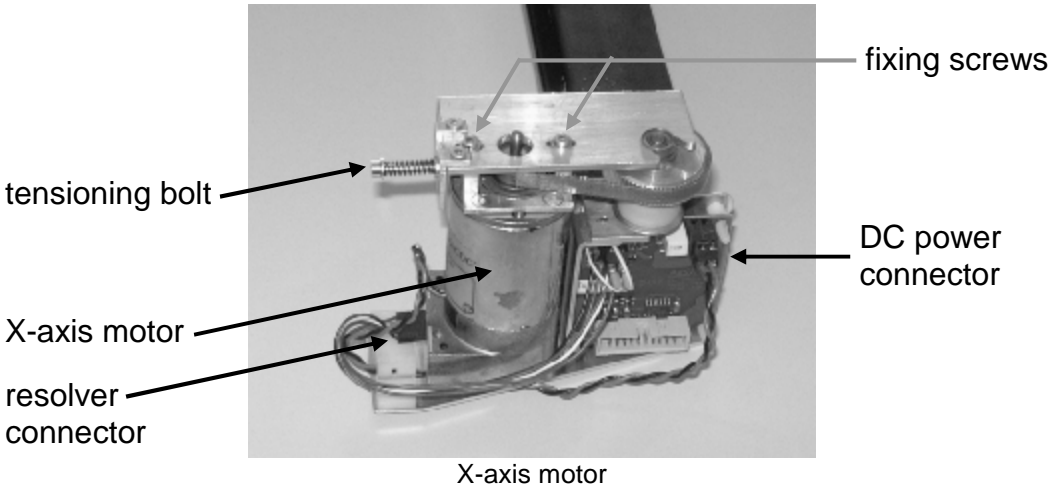

- 3. Release the main belt
 - Remove the tensioning bolt and tensioning wedge

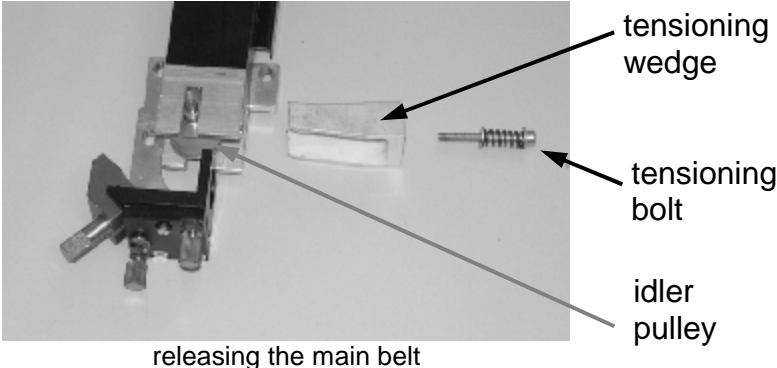

- Remove the four screws and the belt grips on the left and on the right side of the lens holder carriage.

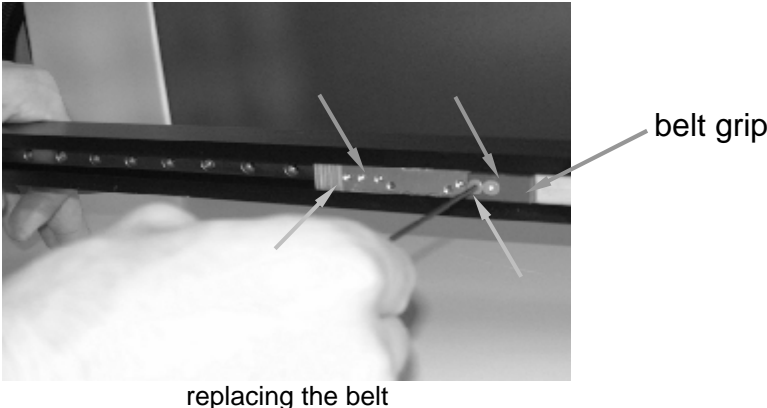

4. Replace the main belt

- Connect the new belt to the old one. Pull out the old belt (and at the same time pull in the new belt)
- 5. Replace the ball bearings, the X-gearing assembly and the motor belt
 - There are ball bearings on the left side and on the right side of the X axis. One each on the upper and lower end of the X-gearing assembly and two on the main belt idler pulley.
 - Take out the gearing assembly (including ball bearings) and the motor belt and replace it.

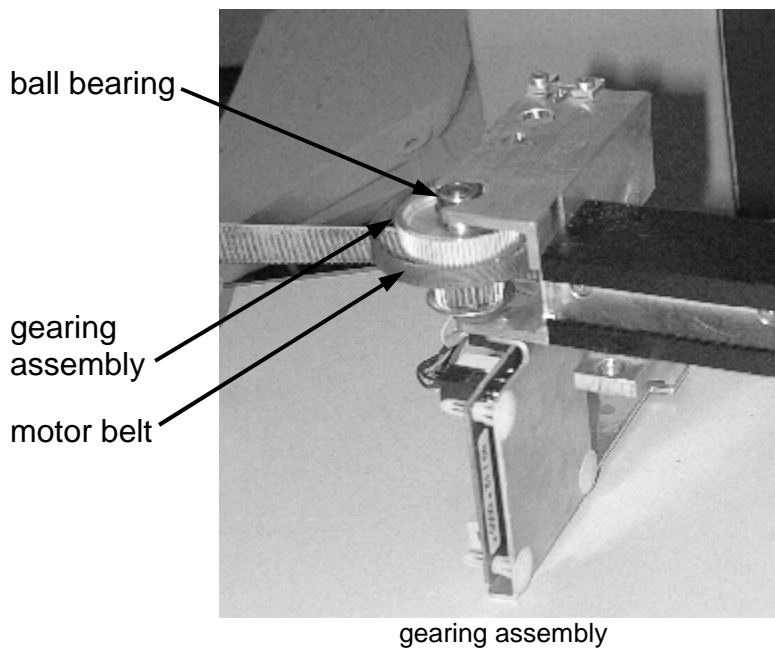

- Take out the idler pulley, remove the old ball bearings and replace them for new ones.

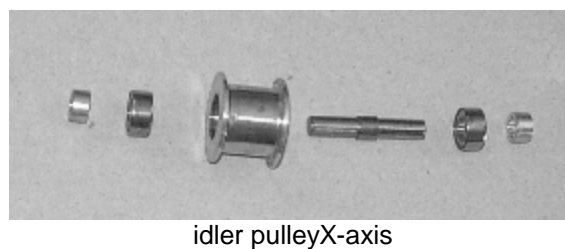

6. Assemble all components in the reverse order.

After a very long time of use also the THK guides must be replaced. This is done between step 4 and 5:

- Remove the mirror unit no.two, bearing holder and carriage stopper.

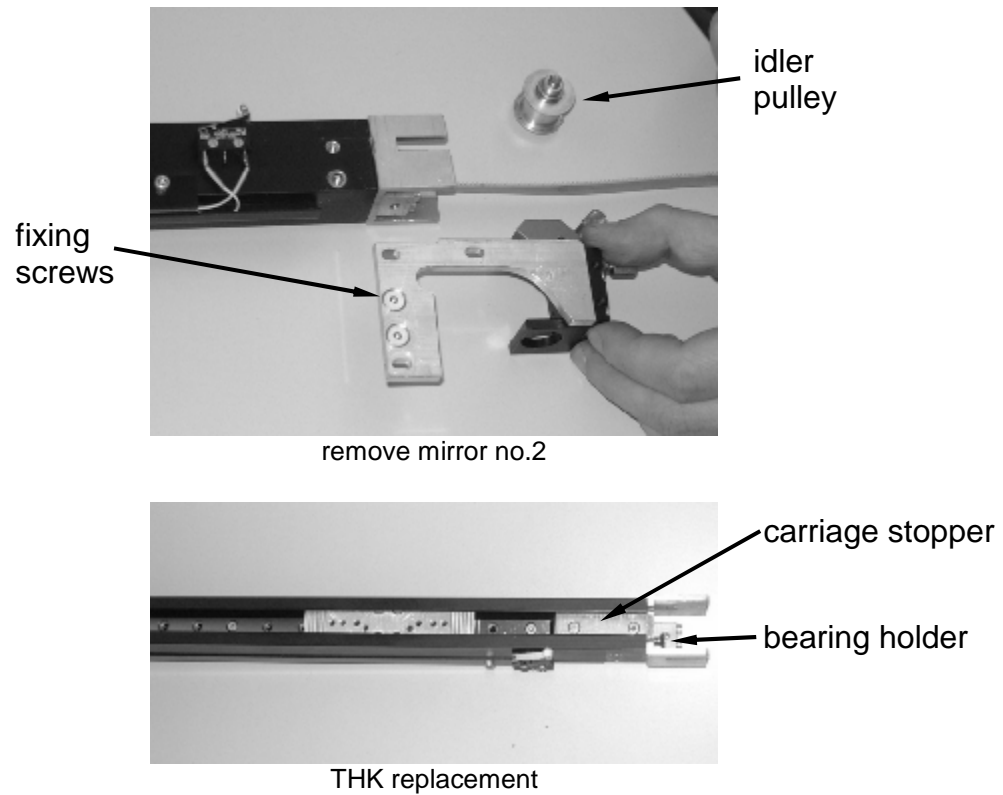

- Remove all screws that fix the THK and slide it to the right
- Replace it and assemble the components in the reverse order

9. Special instructions for X-belt tensioning

Correct belt tensioning is very important for:

- obtaining good engraving results: Are the belts too loose quality of engravings can be poor.
- life expectancy of mechanical parts: Is belt tensioning too high, mechanics like ball bearings, belts, gears, will wear out quickly.

1. Disconnect the laser from mains.
2. Open right and left cover from the laser housing.
3. Remove cover from electronic compartment.
4. Check tensioning of x-gearing belt (small golden belt on the left side of x-axis) by measuring the spring length of TENSIONING BOLT (Fig. 1).
Spring length should be **15 mm**.
In case the spring length is incorrect proceed with following steps:
 - Loosen MOTOR FIXING SCREWS (2 pcs.).
 - Bring the spring to its correct length (and simultaneously the belt to the correct tensioning), by screwing the TENSIONING BOLT in or out.
 - Tighten the MOTOR FIXING SCREWS.
 - Re-check spring length again. If necessary repeat the tensioning process.

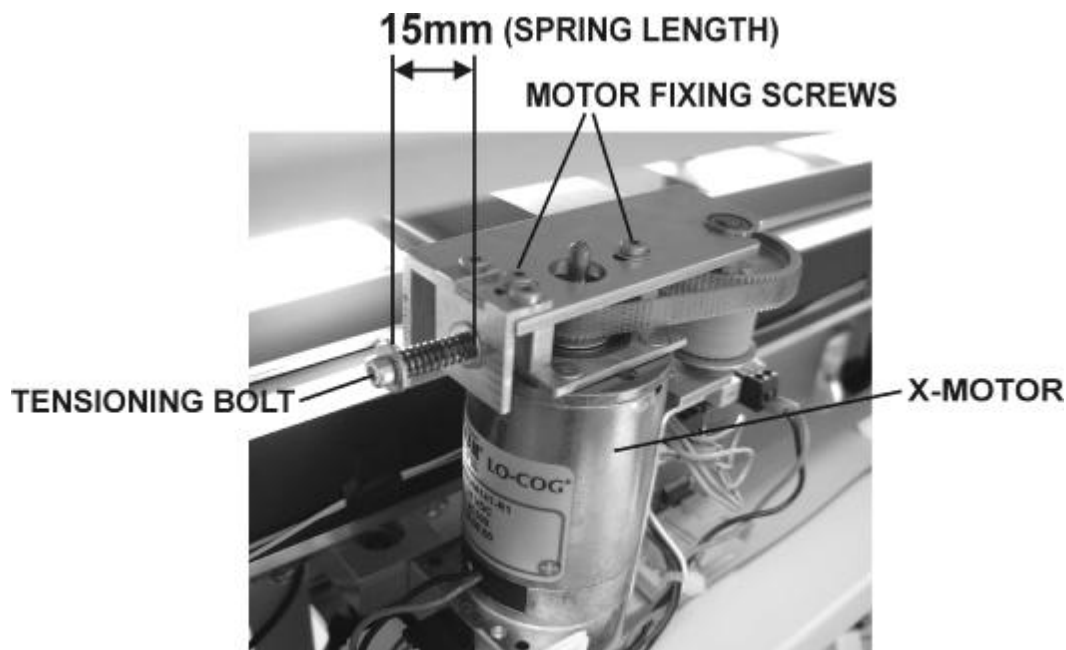

Fig. 1

5. Check tensioning of x-main belt (grey belt that drives lens holder) by measuring the spring length of TENSIONING BOLT (Fig. 2).

Spring length should be **12 mm**.

In case the spring length is incorrect proceed with following steps:

- Bring the spring to it's correct length, by screwing the TENSIONING BOLT in or out.
- Pull out the TENSIONING WEDGE manually and let it spring back, this will tension the belt. Do this four or five times until the wedge goes allways back to the same position.
- Re-check spring length again. If necessary repeat the tensioning process.

Attention: TENSIONING BOLT must not touch the belt !

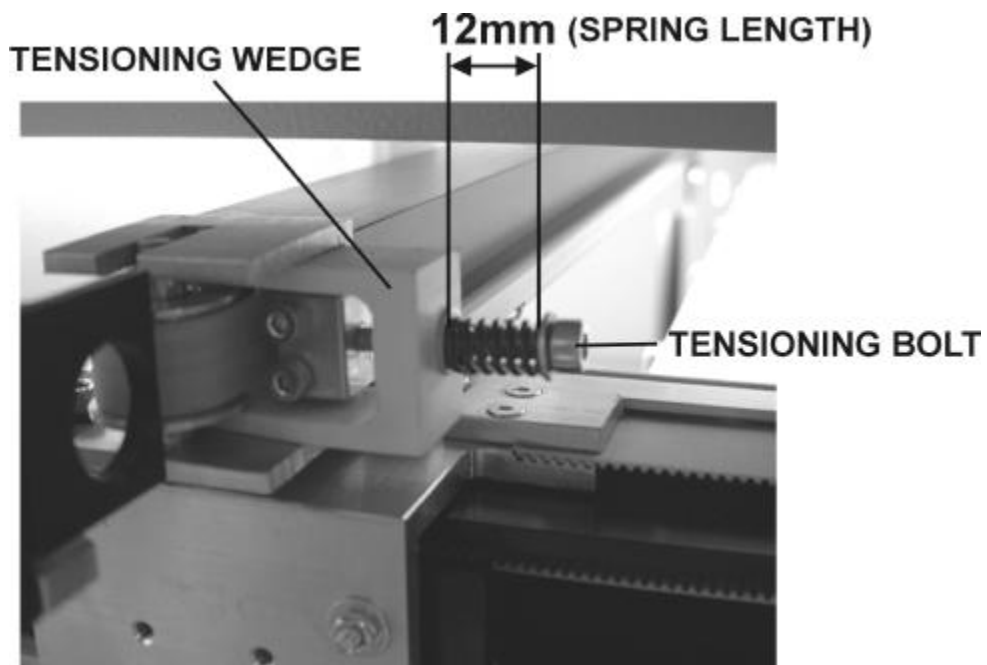

Fig. 2

6. Tensioning of x-belts is finished. Replace all removed covers to the housing.

10. Instructions for changing the X-gearing assembly

1. Disconnect the laser from mains.
2. Open right and left cover from the laser housing.
3. Remove cover from electronic compartment.
4. Mark the position (scribe a line) of the TENSIONING WEDGE and TENSIONING BOLT on the right side of x-axis. (Fig. 1)
5. Remove the TENSIONING BOLT and TENSIONING WEDGE (Fig. 1). This will loosen the x-axis main belt.

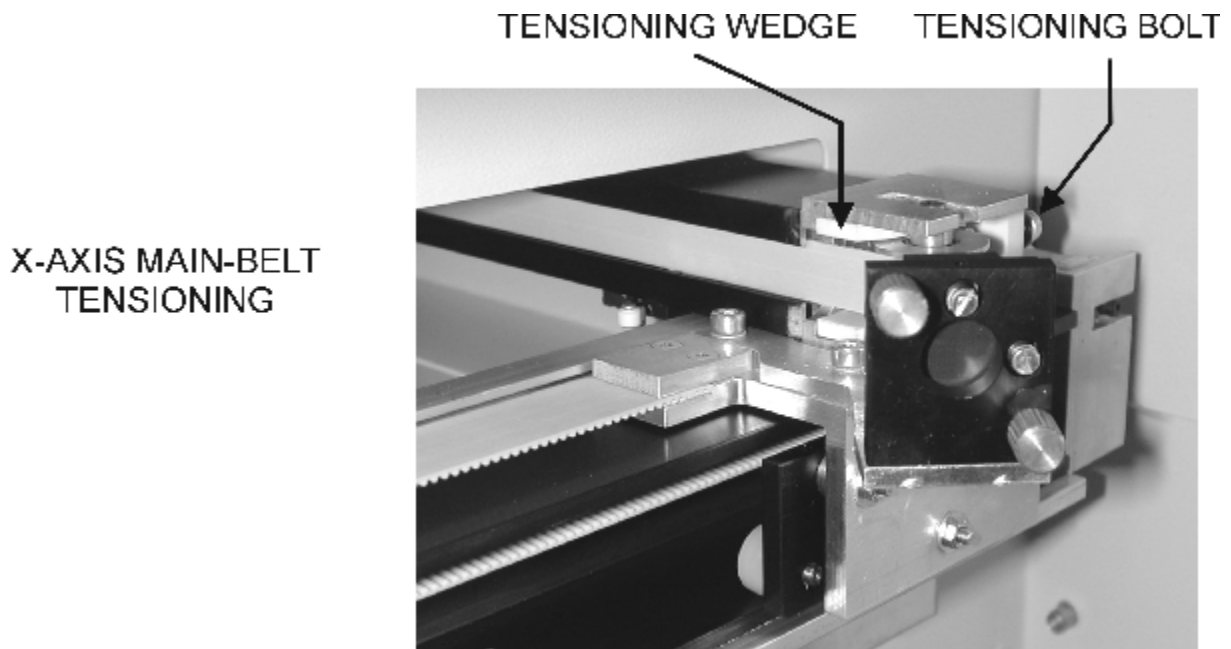
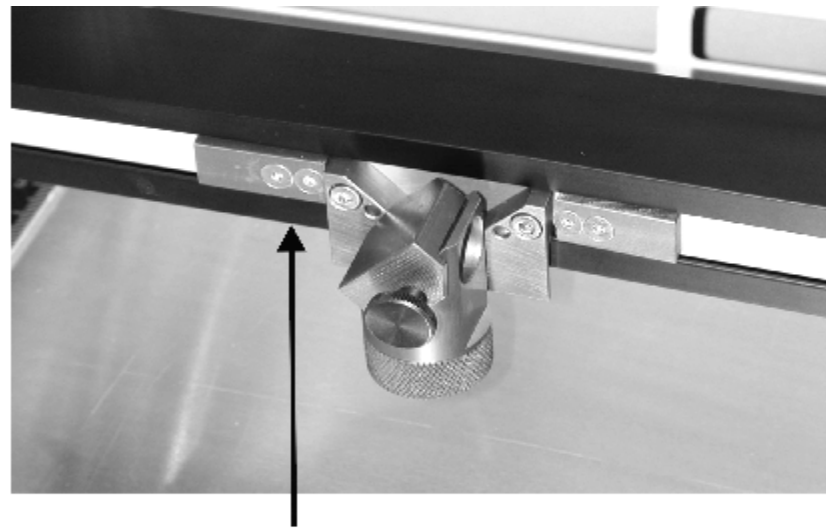

Fig. 1

6. Remove the two screws and the BELT GRIP on the left side of lens holder. (Fig. 2)

LENS HOLDER



BELT GRIP

Fig. 2

7. Mark the position of the two MOTOR FIXING SCREWS and TENSIONING BOLT on the left side of x-axis. (Fig. 3)
8. Remove the two MOTOR FIXING SCREWS, TENSIONING BOLT and X-AXIS MOTOR. (Fig. 3).

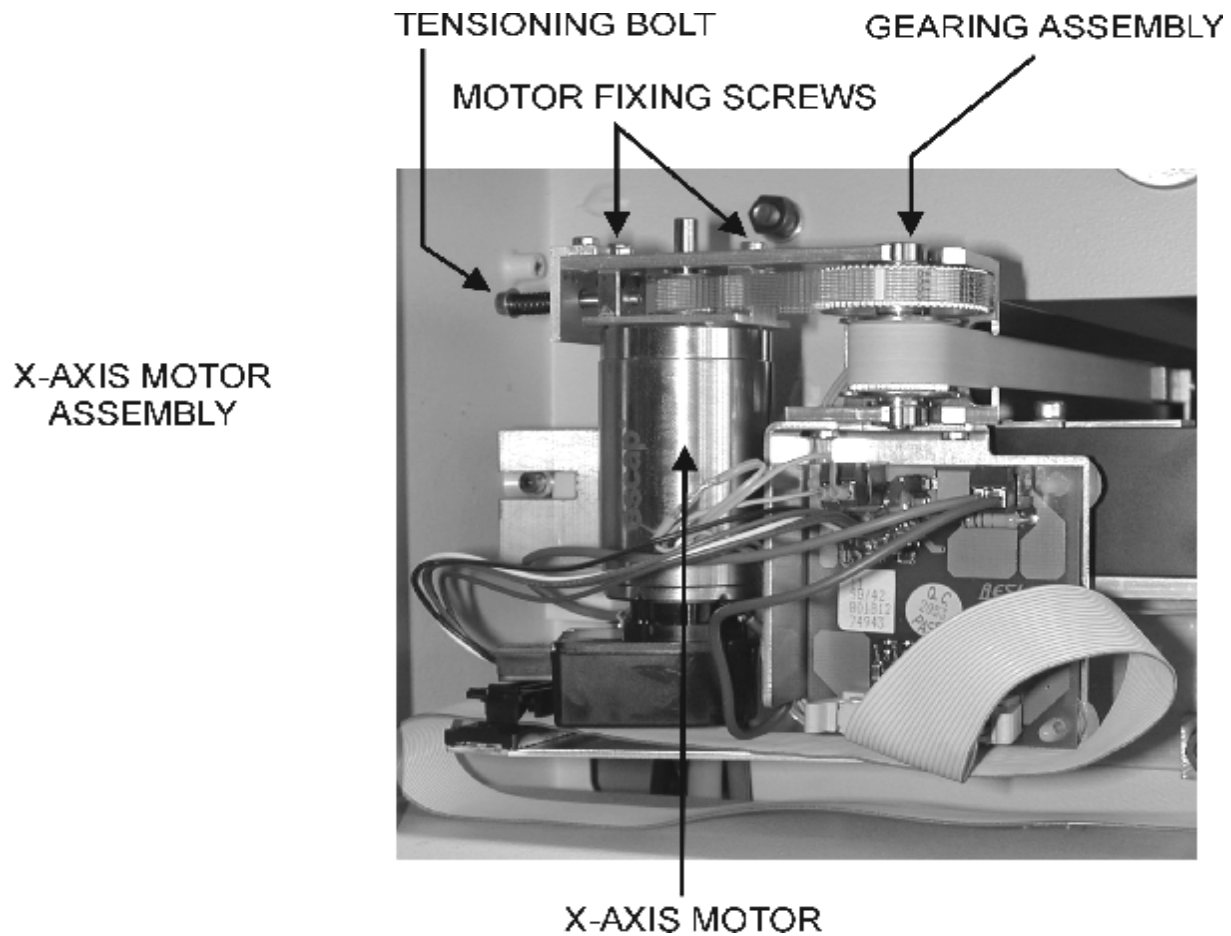

Fig. 3

9. Now the GEARING ASSEMBLY can be removed.

10. Assembling the system is reversed.

Be carefull to bring the MOTOR TENSIONING SCREWS, TENSIONING WEDGE and TENSIONING BOLTS in their marked position to ensure correct belt tensioning. The TENSIONING BOLTS must not touch the belt!!

Re- tension of belts is very important to attain good engraving results.

Attention: Do not overtight screws !!

11. Servicing the Y axis left part

The left part of the Y axis is similar to the X axis. It contains also a THK guide, main belt, motor belt and motor.

Steps for servicing the Y-axis:

7. Take the X-axis out of the machine (please refer to the chapter: Servicing the X axis)
8. Open the flexible coupling (which is located behind the illumination panel)
 - Move the table to it's top position
 - Remove the illumination panel (three screws). Be careful not to damage the wiring of the interlock system and lights.

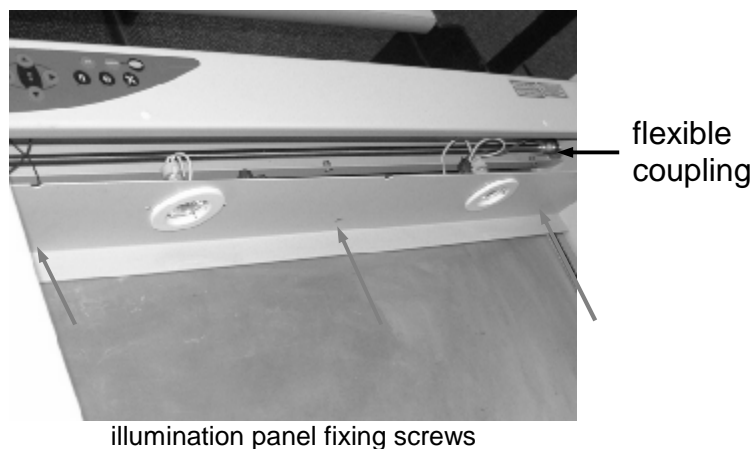

- Open the two screws that are positioned 90° turned to each other, but only on the side closer to the Y axis motor.

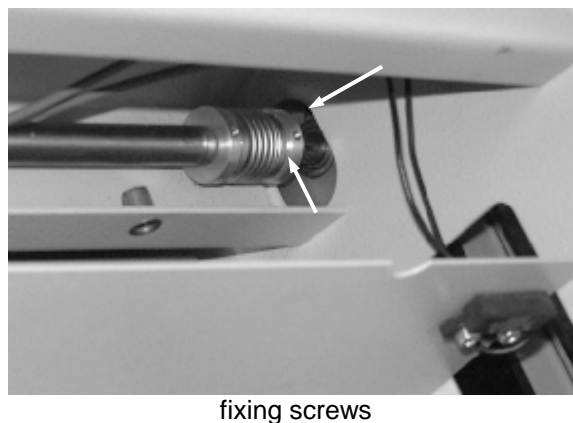

9. Take the left Y-axis out of the machine



fixing screws

10. Dismantle the Y-motor

- Loosen the two motor fixing screws
- Take out the tensioning bolt
- Take out the motor

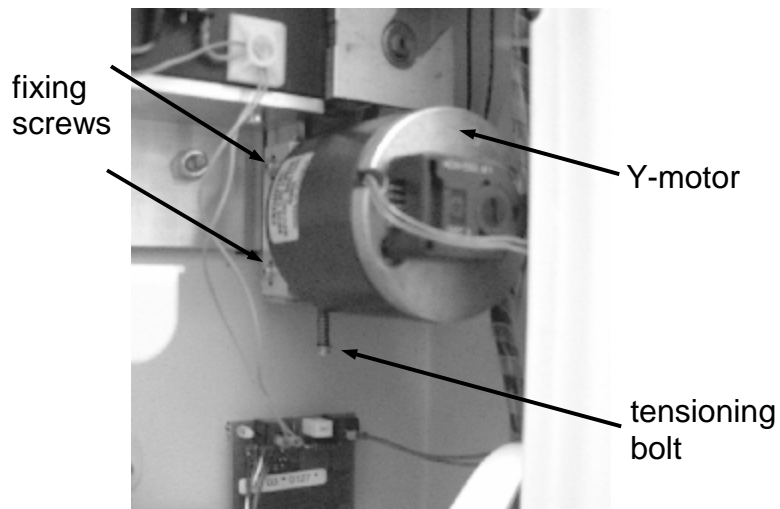

11. Release the main belt

- Remove the tensioning bolt and tensioning wedge
- Remove the four screws and the belt grips on the front and the back of the X axis carriage (This step is identical to the X-axis).

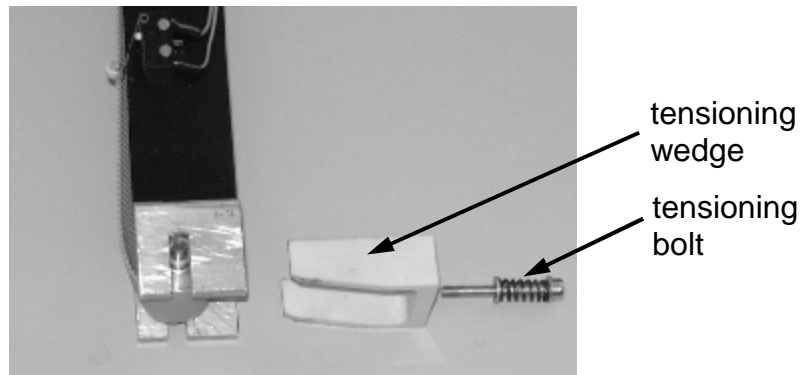

12. Replace the main belt

- Connect the new belt to the old one. Pull out the old belt (and at the same time pull in the new belt)

13. Replace the ball bearings, the Y-gearing assembly and the motor belt

- There are ball bearings on the front and on the back of the Y axis.
One each on the upper and lower end of the Y-gearing assembly and two on the main belt idler pulley.
- Take out the gearing assembly (including ball bearings) and the motor belt and replace it.

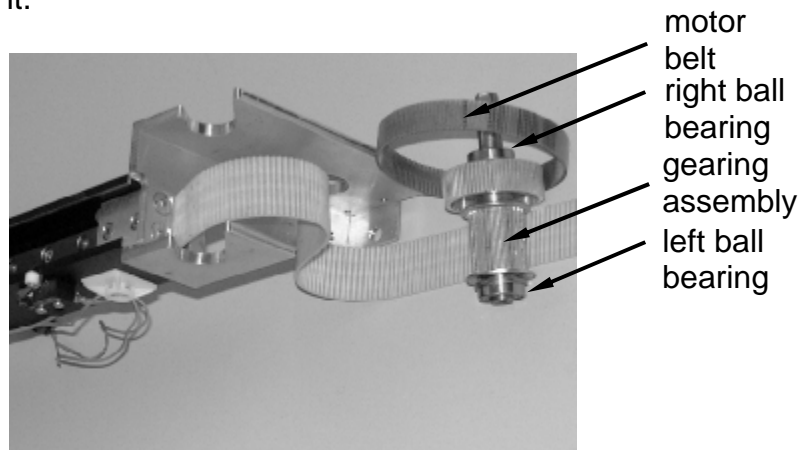

replace gearing assembly

- Take out the idler pulley, remove the old ball bearings and replace them for new ones.

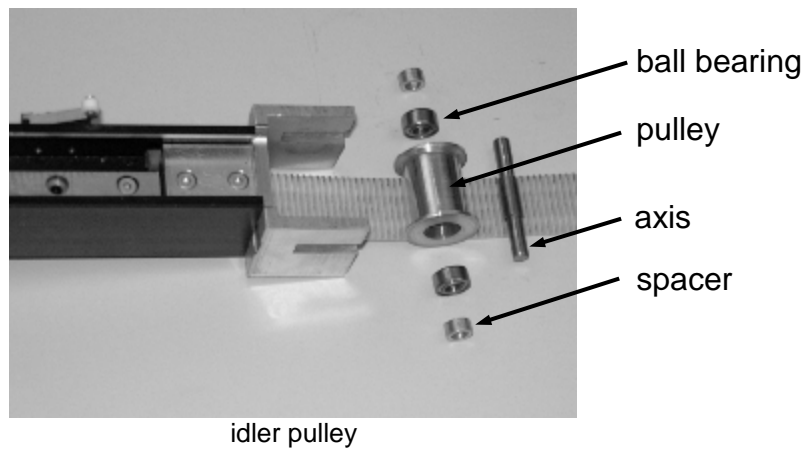

14. Assemble all components in the reverse order. Tension the belts so that you have a spring length of 11mm at the main belt tensioning bolt and 13mm for the motor belt tensioning bolt.

After a very long time of use also the THK guides must be replaced. This is done between step 5 and 6:

- Remove the mirror unit no.two, bearing holder and carriage stopper.
- Remove all screws that fix the THK and slide it to the back
- Replace it and assemble the components in the reverse order

Please refer to „servicing the X axis“

12. Servicing the Y axis right part

The right part of the Y axis is a unique construction that you will find only in Trotec machines. This construction makes sure that all three bearings are in contact with the guide rail at any time. To reach that we use one spring loaded bearing which presses against the rail.

The Y axis right part contains a Y axis bearing assembly and our well tried system of belt tensioning.

Steps for servicing the Y-axis:

15. Take the X-axis out of the machine (please refer to the chapter: Servicing the X axis)
16. Open the drive shaft connector
17. Take the right Y-axis out of the machine
 - There are five screws that fix it from the lower side to the aluminium profile

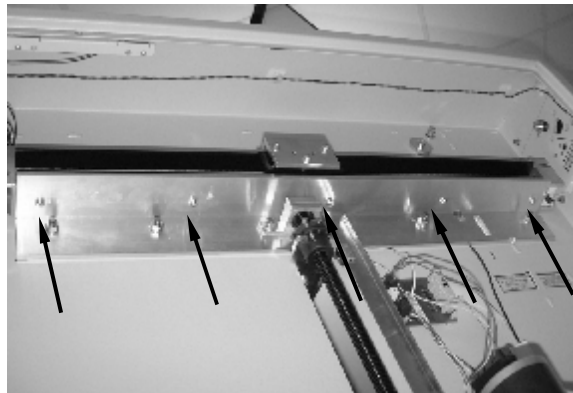

fixing screws of the Y-axis

18. Release the main belt
 - Remove the tensioning bolt and tensioning wedge

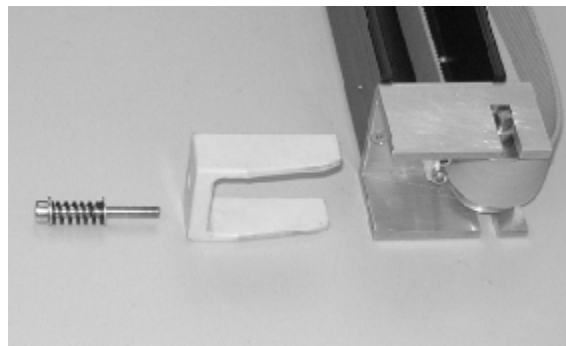

tensioning elements

- Remove the four screws and the belt grips on the front and the back of the X axis carriage. Replace the Y-axis bearing assembly.

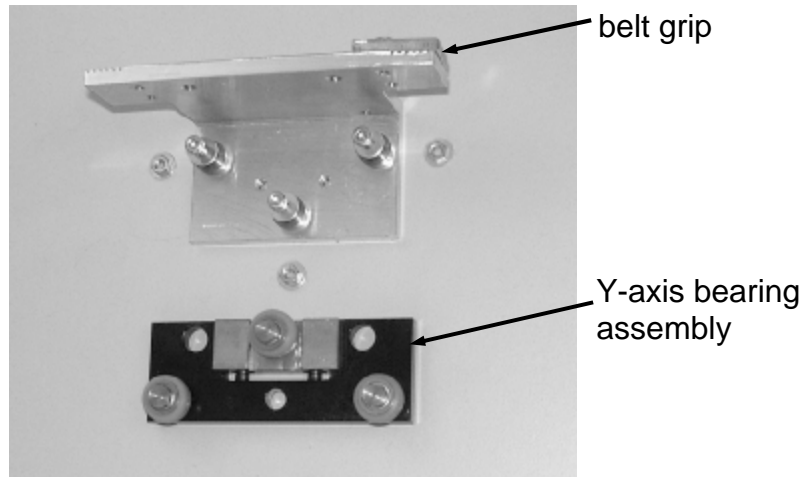

replacement of the bearing assembly

19. Replace the main belt

- Connect the new belt to the old one. Pull out the old belt (and at the same time pull in the new belt)

20. Replace the ball bearings, the Y axis drive gear and the motor belt.

There are ball bearings on the front and on the back of the Y axis. Two on the drive gear and two on the main belt idler pulley.

- Take out the drive gear. Put in a new one and replace also the ball bearings

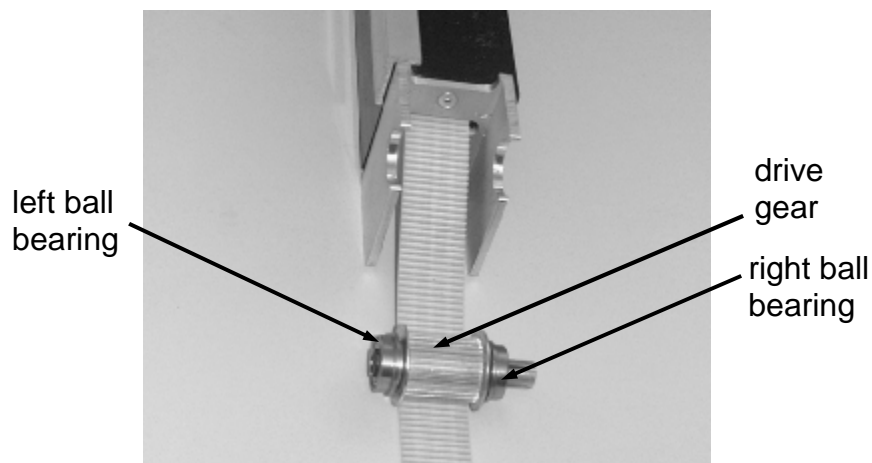

drive gear assembly

- Take out the idler pulley, remove the old ball bearings and replace them for new ones.

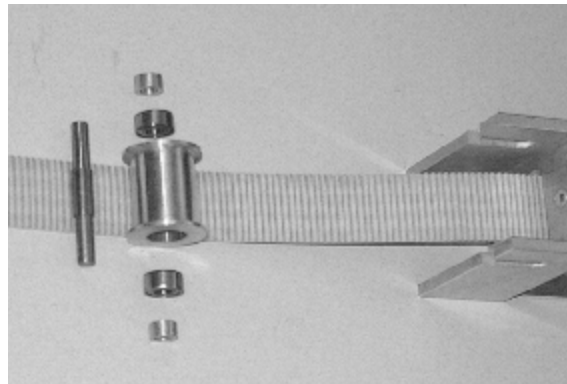

idler pulley assembly

21. Assemble all components in the reverse order. Tension the belts so that you have a spring length of 11mm at the main belt tensioning bolt.

13. The electric system of the Speedy

The Speedy is an advanced servo motor system, that contains the following electrical components:

1. Main board motion system
2. CPU board
3. Motor print
4. Power supply
5. Laser tube
6. Halogen lights+light transformer
7. X axis motor
8. Y axis motor
9. Z axis motor
10. Keypad
11. Cooling fans
12. Air compressor (optional)
13. Cables

In case of a breakdown you can order spare parts and replace the component.
For checking the system we recommend to use an electronic multimeter (Voltage check, Ohmmeter)

Block wiring diagram

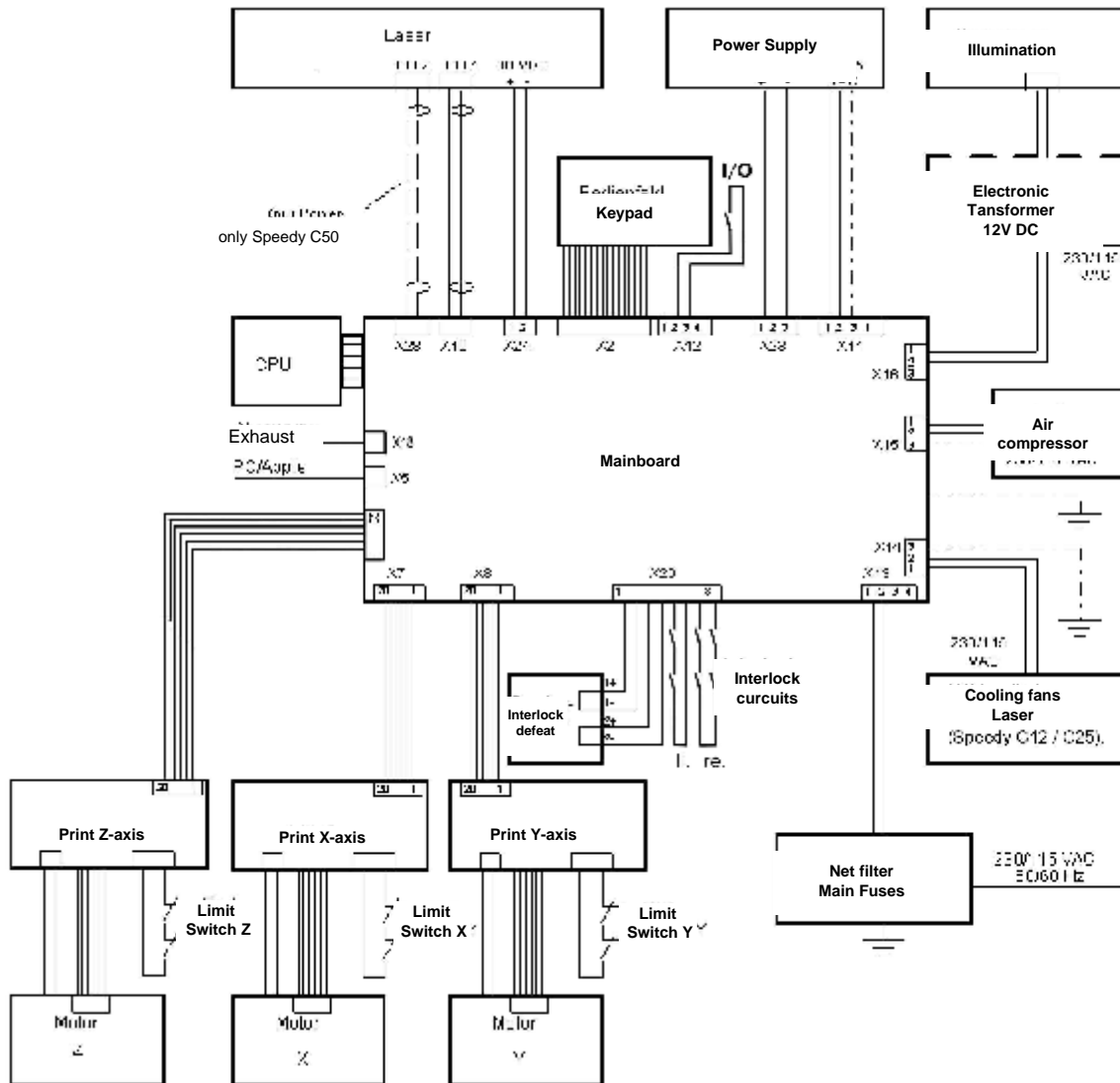

Connector Assignment

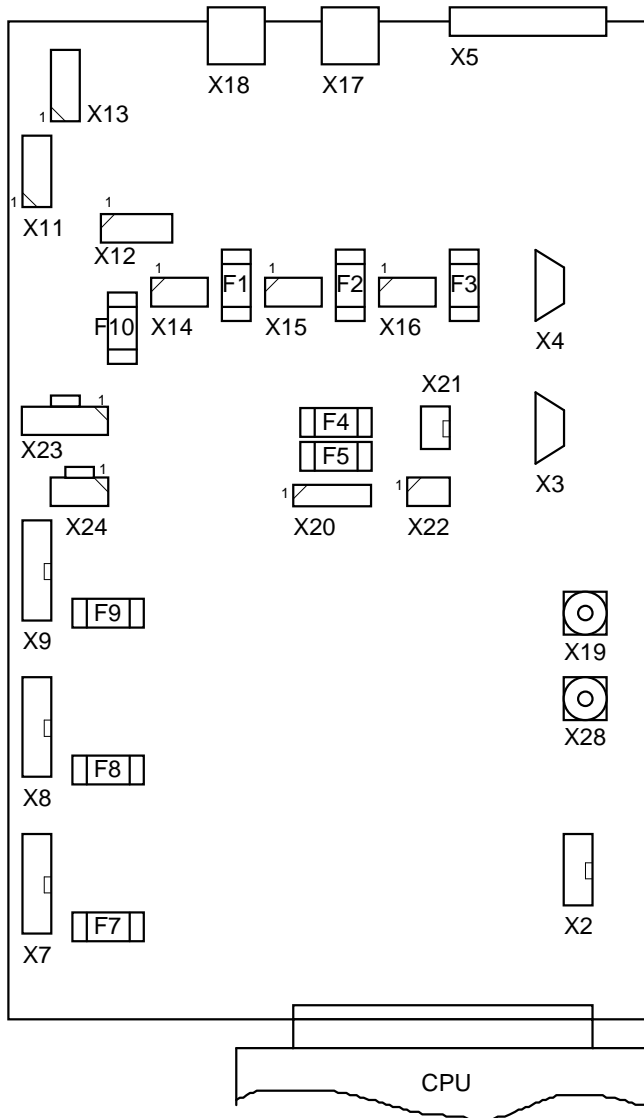

ACHTUNG: Vor dem Öffnen des Gehäuses Netzstecker ziehen.

CAUTION: Before opening the system unplug the mains

Sicherungen im Power-Laser Pro

Netzspannung:	230 VAC	115 VAC
Hauptsicherungen	2 x 6,3 AT	2 x 10 AT
Relais-Einschaltkreis	F10	200 mAT
Kühlventilatoren-Laser	F1	1 AT
Luftkompressor	F2	1 AT
Gravurraum-Beleuchtung	F3	1 AT
interne DC-Versorgung	F4	2 AT
interne DC-Versorgung	F5	2 AT
DC-Versorgung X-Achse	F7	6,3 AT
DC-Versorgung Y-Achse	F8	6,3 AT
DC-Versorgung Z-Achse	F9	6,3 AT

ACHTUNG: Sicherungen nur durch solche vom gleichen Wert und Typ ersetzen !

Fuses in the Power Laser Pro

Mains voltage		230 VAC	115 VAC
Main fuses		2 x 6.3 AT	2 x 10 AT
Relay	F10	200 mAT	200 mAT
Cooler fans - Laser	F1	1 AT	2 AT
Air compressor	F2	1 AT	2 AT
Illumination Engr. Area	F3	1 AT	2 AT
Internal DC supply	F4	2 AT	2 AT
Internal DC supply	F5	2 AT	2 AT
DC supply X axis	F7	6.3 AT	6.3 AT
DC supply Y axis	F8	6.3 AT	6.3 AT
DC supply Z axis	F9	6.3 AT	6.3 AT

Caution Replace fuses only with the same value and type

Checking the different components:

Some components can be checked easily by performing only a few steps. These tests are described here. Additionally a lot of electronic problems can be recognized in the engraving result.

How to check the power supply

Open the service access panel and the cover of the electronic compartment. Switch on the machine. Make sure that there is net voltage on connector X11 (between pin 1 and 2). Measure the output voltage at connector X23. It must be close to 30V DC.

How to check the transformer

Open the service access panel and the cover of the electronic compartment. Switch on the machine. Make sure that there is net voltage on connector X16 (between pin 1 and 2). Measure the output voltage at the output of the transformer. It must be close to 12V AC.

How to check the Motorprints

Whenever you think there is a problem with one of the motorprints (e.g. because one of the axes doesn't reference) then replace two of the boards for the different axes (all of them are identical). If then suddenly the axis that has previously shown a problem works fine, you know that only the motorprint shows a problem and must be replaced.

14. Firmware Update

Each laser engraver is controlled by the CPU board. Signals that come from the Computer are interpreted as commands which cause a certain sequence of operations that are fulfilled. The way these commands are interpreted is strongly influenced by the firmware.

Whenever we find a way to optimize the behaviour of the engraver there will be a new release of the firmware, which can easily be updated by any user.

But be aware that with every firmware update you reset the

- Engraver hours
- Laser hours
- Engraving time with plugged filters
- Distance of travel X axis
- Distance of travel Y axis

This means you lose a lot of information when these parameters are not noted before updating (especially the amount of laser hours is important which will very often be used to decide whether a replacement will be warranty or non warranty).

Steps for updating the firmware

- 1.) Make sure you have the Firmware stored on Disk or in a directory in uncompressed format. (Often the Trotec Support team will send you the files per e-mail, which sometimes makes it necessary to compress them. In this case first decompress them and store them in any directory)
- 2.) Switch your laser engraver off and then on again, to make sure there is no communication between the two.
- 3.) Open the manager (but do not build up a connection)
- 4.) Select Settings>Update Firmware and enter the path name where you have saved the Firmware files.
- 5.) Wait until the download has been finished.

In some cases this way of updating the Firmware does not work (e.g. you have used a corrupt file for updating and the manager can not transfer the data a second time) In this case you have to update the Firmware by connecting directly to the CPU board. To do this you need:

- A PC link cable (nomodem cable)
- The firmware (here the two files loader.ini and loader.exe are very important)
- A set of allen keys metric

CAUTION: To prevent an electric hazard never touch any part of the boards while the machine is powered. Make sure that you do service work on an open machine only when is installed to an electric network using an FI breaker of max. 40mA.

- 1.) Open the service access panel (on the left side of the machine) and the cover of the electronic compartment.
- 2.) Place the jumper from the position closer to the Main board to the position closer to the CPU board and connect one end of the link cable to the 9-pin socket closer to the CPU board (if you have a set of first generation boards, otherwise you will have only one 9-pin socket on the board)
- 3.) Open the loader.ini file, and select the COM port of the computer you are using for updating the firmware (commport=0 for COM1 and commport=1 for COM2)
- 4.) Make sure that your engraver is switched on.
- 5.) Press the reset button on the CPU Board (black push button)
- 6.) Start the loader.exe file to begin with the update.
- 7.) Wait until you get the message: All files loaded successfully.
- 8.) Place back the blue jumper in it's original position and close the panels again.

15. Network installation of Trotec laser engravers

Your Trotec Laser engraver can be installed also in a network. This will make it possible to send jobs from any computer in the network to the job queue of the computer that runs the laser.

You need:

- One computer to run the laser (and create jobs)
- Several computers to create jobs

Steps for creating a network installation:

1. Install the printer driver and the Trotec manager on all your computers.
2. Map on every computer (except the one that runs the laser) a network drive to: *Computer_that_runs_the_laser \ Hard_Disk_where_manager_is_installed \ Directory_where_manager_is_installed*
3. Alter in the trotec.ini file, which is located in the Windows directory of every computer, the lines:

<i>ArchivePath=C:\Trotec\Archiv\</i>	<i>to</i>	<i>ArchivePath=Mapped Drive:\Archiv\</i>
<i>SpoolPath=C:\Trotec\Spool\</i>	<i>to</i>	<i>SpoolPath=Mapped Drive:\Spool\</i>
<i>WorkPath=C:\Trotec\Work\</i>	<i>to</i>	<i>WorkPath=Mapped Drive:\Work\</i>
<i>ApplicationPath=C:\SPEEDY\</i>	<i>to</i>	<i>ApplicationPath=Mapped Drive:\</i>

The trotec.ini file looks like this:

```
[Status]
Running=0

[UserSetup]
ForwardToNet=0
IgnoreAbsWarn=0
CuttingBorder(mm)=1.0
VentDelay(min)=1.0
Tickle(0...255)=25
UseRotaryFixture=0
RotaryDiameter(mm)=63.0
UseInch=0
ZProgress(mm)=2.0100
CurrentUnit=0
LayerCount=64
Crosswise=0
LensIndex=0
ArchivePath=C:\Trotec\Archiv\
SpoolPath=C:\Trotec\Spool\
WorkPath=C:\Trotec\Work\
SerialPort=COM2

[AdvancedSetup]
RubberLevel1(%)=70
RubberLevel2(%)=30
TickleDelay(0...255)=2
PowerTestpuls(%)=10
LaserFrequency(Hz)=5000
MaxGraveVelocity(cm/s)=200
MaxCutVelocity(cm/s)=80
AccelSettingV(1)=1
AccelSettingK(1)=1
AccelSettingX(1)=9
AccelSettingY(1)=4
Language=1
```

INDIVIDUAL MARKING SYSTEMS

```

OvrShtAnzahl=2
OverShoot0=" 1 2 0.03 0.00"
OverShoot1=" 22 12 0.00 -0.03"
OffsetX(mm)=13.7000
OffsetY(mm)=4.5000
OffsetZ(mm)=6.9000
Accel=5.0000
CorrK1=15
CorrK2=0
CorrK3=0
GMODE=2
EngraverType=3
NewOverShoot0=" 1.0 2.0 0.03 0.00"
NewOverShoot1=" 22.0 12.0 0.00 -0.03"
EngraverModel=1
PowerCorrection=0
NewOverShoot2=" 44.0 10.0 -0.06 -0.07"
OverShoot2=" 44 10 -0.06 -0.07"
ApplicationPath=C:\SPEEDY\

```

```

[Driver]
Werkstueck=256
Material=258
Job-Name=SP0466
Job-Number=000513_23
Job-Count=611
QuickPrint=0

```

```

[CurrentWerkstueck]
Werkstueck[1].UseTemplate=0
Werkstueck[1].TemplateIndex=-1
Werkstueck[1].Name=Printy 4927
Werkstueck[1].UseRotary=0
Werkstueck[1].IsCircle=0
Werkstueck[1].Width[mm]=100
Werkstueck[1].Height[mm]=60
Werkstueck[1].ResIndex=1
Werkstueck[1].Process=1
Werkstueck[1].Flanke=1
Werkstueck[1].AutoCut=0
Werkstueck[1].DoRaster=1
Werkstueck[1].CutFreq=1
Werkstueck[1].EngraveMode=0

```

```

[CurrentMaterial]
Material[1].UseTemplate=1
Material[1].TemplateIndex=18
Material[1].Name=Wood/Madera Bit map
Material[1].LSGrave.Vel=70
Material[1].LSCut.Vel=100
Material[1].LSGrave.Power=92
Material[1].LSCut.Power=92
Material[1].LSGrave.PPI=250
Material[1].LSCut.Frequency=2000
Material[1].Thickness[mm]=0.0000
Material[1].LSGrave.VelEx=1000
Material[1].LSCut.VelEx=10

```

```

[DefaultMaterial]
Material[1].UseTemplate=0
Material[1].TemplateIndex=-1
Material[1].Name=Material 1
Material[1].Thickness[mm]=1.0
Material[1].LSGrave.VelEx=50
Material[1].LSCut.VelEx=10
Material[1].LSGrave.Power=30
Material[1].LSCut.Power=70
Material[1].LSGrave.PPI=1000
Material[1].LSCut.Frequency=1000

```

```

[DefaultWerkstueck]
Werkstueck[1].UseTemplate=0
Werkstueck[1].TemplateIndex=-1
Werkstueck[1].Name=Werkstueck 1
Werkstueck[1].UseRotary=0
Werkstueck[1].IsCircle=0
Werkstueck[1].Width[mm]=70.0
Werkstueck[1].Height[mm]=30.0
Werkstueck[1].ResIndex=0
Werkstueck[1].Process=0
Werkstueck[1].Flanke=0
Werkstueck[1].AutoCut=0
Werkstueck[1].DoRaster=1
Werkstueck[1].EngraveMode=0
Werkstueck[1].CutFreq=0

```

4. Delete on the computers that do **not** run the laser all files in the local directories where the manager is installed (normally the „Trotec“ directory)

16. Software tips&tricks

Rastering images in Corel Draw

Engraving grayscale images is a frequently used application. Whenever you engrave a grayscale on a two colored material (kernel material and thin colored layer on top) you should first raster it. This makes sure that grayscales will show up as on the screen.

A raster image is a picture which represents grayscales by a combination of black and white dots in different sizes. So for the eye the impression of having different brightnesses is generated.

There is a big variety of raster options available. We recommend some options that have been tested in our factory. In some cases it will be necessary to alter them to get an optimized result.

To raster an image perform the following steps (valid for Corel Draw 9):

1. Import the image into Corel Draw. (the resolution should be at least 300dpi, 500 is recommended)
2. Convert the image to a Bitmap (Bitmaps>Convert to Bitmap: Grayscale 8bit)
3. Raster the image (Bitmap>Mode>Black and White: Conversion Halftone, Screen type round, 60 degrees, 80 lines per inch)
4. Send the job to the manager (check dithering none in the tab Graphics of the printer driver properties)

How to produce a Seal Press

A Seal press is used to perforate paper by using a positive and a negative die. The paper is put between them so that after compressing the stamping is visible.

To reach great clearance the negative (female) side must be enlarged to prevent the paper from piercing through when the positive (male) side of the seal presses into the negative side.

Description for Corel Draw 9:

Steps for creating a seal press:

1. Create the bottom part as graphic with white objects on black background (positive)
2. For the top side use enlarged mirrored black objects on white background:
 - Make a copy of the positive and mirror it.
 - If there are Outlines in the image that are dotted select them and chose Arrange>Convert Outline to Object
Change the Outline thickness to 0.5mm (color white)
 - Select all filled Objects, chose Arrange>Convert to Curves and alter the Outline thickness to 0.5mm (color white)
 - Invert the image: Effects>Transform>Invert
3. Now you can draw a cut line around positive and negative and run the job. The engraving depth should reach approximately 0.8mm.

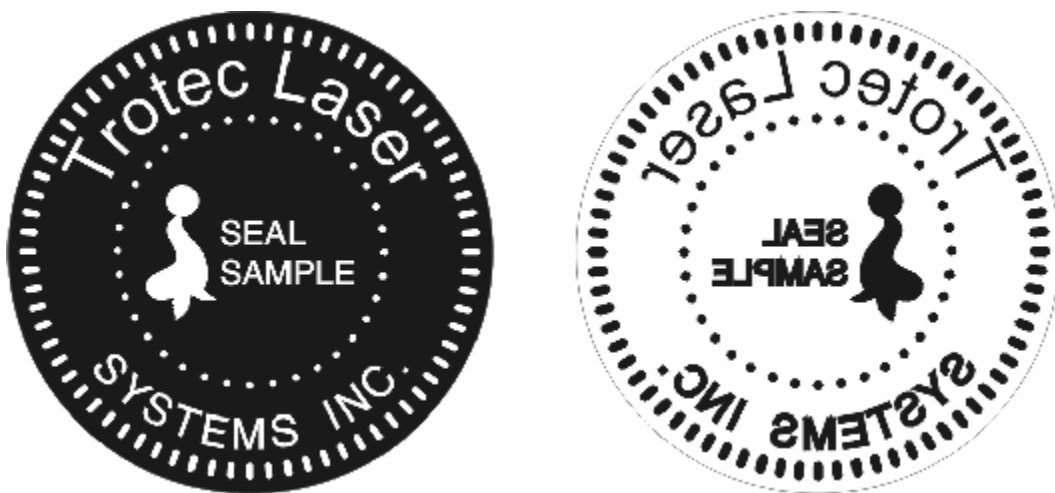

positive (male) and negative (female) part of a seal press

17. Marking metals using metal mark paint

Normally it's not efficient to mark metals using a CO₂ laser engraver. But there is a useful possibility using a special chemical substance. This substance is painted on your workpiece. Afterwards you laser into the surface, which will fix the coating. (The laser radiation will be absorbed on the parts of the surface which are covered by the paint)

Not fixed areas can be washed away with water.

Trotec can recommend the following company for delivering the metal mark paste:

DEURA Laser GmbH&Co. KG
Mühlhofer Hauptstraße 9
D-90453 Nürnberg
Tel: 0911/9648310
Fax:0911/9648333
Deura_Indul@t-online.de
www.deura.de

Please mention that the contact has been established by Trotec.

18. Speedy error codes

Software feedback

The following error codes can be generated by the Trotec Manager, whenever it recognizes a machine or computer problem. In many cases these codes are a helpful information which makes it easier to sort out problems.

Nevertheless sometimes the indication of an error code can be confusing, because machine errors (that are indicated by beeping and blinking of the machine) might cause a software error as well although the true cause is the machine.

```
// ERROR Definitions
const TR_ERR    TR_NO_ERROR                = 0;    // no error
occured
const TR_ERR    TR_ERR_UNDEFINED           = -999;  // should
never occur
const TR_ERR    TR_ERR_ASSERTION_FAILED   = -998;  // Assertion failure
in release version
const TR_ERR    TR_ERR_USER_INFO          = -997;  // This is
an info for the user

const TR_ERR    TR_TRANS_INIT_FAILED      = -200;  //
Initialisation of com port failed
const TR_ERR    TR_TRANS_CHECKCONNECTION_FAILED = -201;  // Echo packet not
correctly received
const TR_ERR    TR_TRANS_IN_PROGRESS      = -202;  // Other
transmission is in progress
const TR_ERR    TR_TRANS_WRONG_ECHO_DATA  = -203;  // Echo
packet contains wrong data
const TR_ERR    TR_TRANS_TIMEOUT          = -204;  // Timeout
occured
const TR_ERR    TR_TRANS_NO_DATA          = -205;  // No data
pending
const TR_ERR    TP_FUNCTION_FAILED        = -206;  // Some "TP"
function failed to succeed
const TR_ERR    TR_TRANS_ABORT_NOT_VALID  = -207;  // No abort
valid in this state
const TR_ERR    TR_TRANS_ABORT_FAILED     = -208;  // No abort valid in
this state
const TR_ERR    TR_MEMORY_ERROR           = -209;  // Failed to
allocate memory
const TR_ERR    TR_OLD_WSSPOOL_VERSION    = -210;  // Failed to
allocate memory
const TR_ERR    TR_WRONG_WSSPOOL_SIZE     = -211;  // Wrong WS spool
size
const TR_ERR    TR_WRONG_MATSPPOOL_SIZE   = -212;  // Wrong WS spool
size
const TR_ERR    TR_OLD_MATSPPOOL_VERSION  = -213;  // Wrong WS spool
size
const TR_ERR    TR_WRONG_JOBSPPOOL_SIZE   = -214;  // Wrong JOB spool
size
const TR_ERR    TR_TRANS_NO_JOBS_FOUND    = -215;  // No jobs found to
```

INDIVIDUAL MARKING SYSTEMS

```

transmit
const TR_ERR    TR_TRANS_JOBS_DIFFERENT          = -216; // Jobs on platte
have different params
const TR_ERR    TR_UPDATE_SETTINGS_CANCELED     = -217; // canceled
update of settings
const TR_ERR    TR_TRANS_SWITCH_FAILED          = -218; // Switch of com
speed failed

const TR_ERR    TR_NOT_IN_IDLE_STATE            = -250; //
transmission should idle here
const TR_ERR    TR_COMM_NOT_READY               = -251; //
communication not ready
const TR_ERR    TR_WRITE_DATA_FAILED            = -252; // could not
write data to comm

const TR_ERR    TR_DOWNLOAD_ABORTED             = -300; // firmware
download aborted
const TR_ERR    TR_DOWNLOAD_OPEN_FAILED         = -301; // could not open
data file
const TR_ERR    TR_DATAGRAM_TIMEOUT             = -302; // no answer
for datagram
const TR_ERR    TR_FATAL_RAM_ERROR              = -303; // RAM error
const TR_ERR    TR_FATAL_FLASH_ERROR           = -304; // FLASH
error
const TR_ERR    TR_RAM_CLEAR_ERROR              = -305; // Could not
clear RAM

const TR_ERR    TR_OPEN_JOB_FILE_FAILED         = -800; // Could not open
job file
const TR_ERR    TR_READ_BMPHEADER_FAILED        = -801; // Could
read file header
const TR_ERR    TR_WRONG_FILE_FORMAT           = -802; // wrong
file format
const TR_ERR    TR_COMPRESSED_DATA_NOT_SUPPORTED = -803; //
compressed data currently not supported
const TR_ERR    TR_READ_BMPINFO_FAILED          = -804; // Could read info
header
const TR_ERR    TR_READ_CUTINFO_FAILED          = -805; // Could read cut
info

const TR_ERR    TR_SEND_QUERY_FAILED            = -806; // Could
send query command
const TR_ERR    TR_GET_INFO_FAILED              = -807; // Got no
info from graver (timeout)
const TR_ERR    TR_ERR_LOADER_SETMARK          = -808; // SetMark of loader
failed
const TR_ERR    TR_ERR_LOADER_OUTOFSYNC         = -809; // loader is out of
sync
const TR_ERR    TR_WRONG_COLOR_DEPTH           = -810; // Wrong
color depth encountered
const TR_ERR    TR_CREATE_BMP_FAILED           = -811; // Could not
create bitmap
const TR_ERR    TR_COLOR_TABLE_ERR              = -812; // Error
retrieving color table

const TR_ERR    TR_READ_TROTECINFO_FAILED       = -812; // No trotec
info found

const TR_ERR    TR_INIT_RUBBER_FAILED           = -900; // could not
initialize rubber
const TR_ERR    TR_INIT_BMPLINE_FAILED         = -901; // could not
initialize bmp line
const TR_ERR    TR_RUBBER_GETLINE_FAILED        = -902; // could not
retrieve line from CRubber
const TR_ERR    TR_JOB_INVALID                  = -903; // invalid (NULL)
job specified
const TR_ERR    TR_MOVE_FILE_FAILED            = -904; // move of

```

INDIVIDUAL MARKING SYSTEMS

```
file failed
const TR_ERR    TR_COPY_FILE_FAILED    = -905; // copy of
file failed
```

Hardware feedback

On any Trotec laser engraver a self test function is implemented which assists you whenever a machine problem occurs.

In such a case the machine will automatically shut down (to prevent further damage) and indicate the problem by a certain combination of beeping and flashing. (There are LED's in the keypad that can be illuminated)

To calculate the error codes Trotec has developed a program, that can show the code number and problem description at a mouseclick.

On the keypad there are two status LED's, a red and a green one, which are important for calculating error codes.

Steps for calculating an error code:

- Start the program firmware error codes (which is on your service CD)

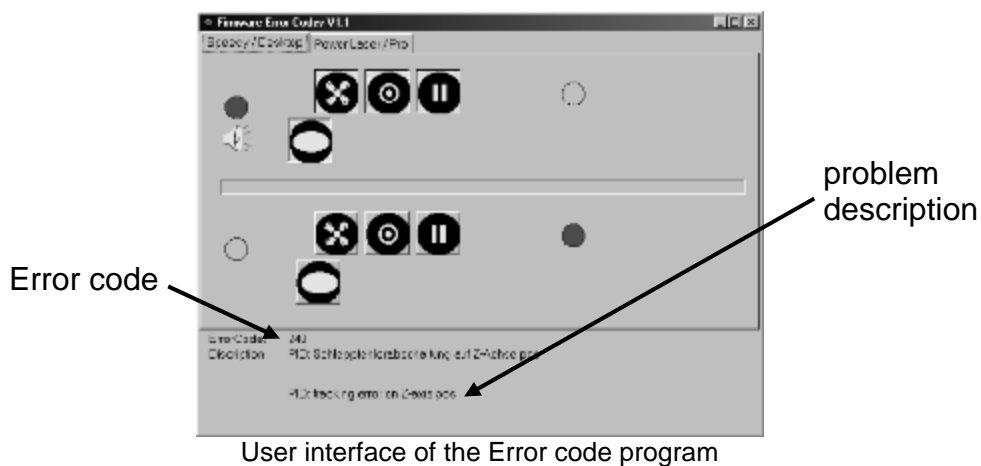

- Click on the symbols that are illuminated at the green status (of the power LED [10])

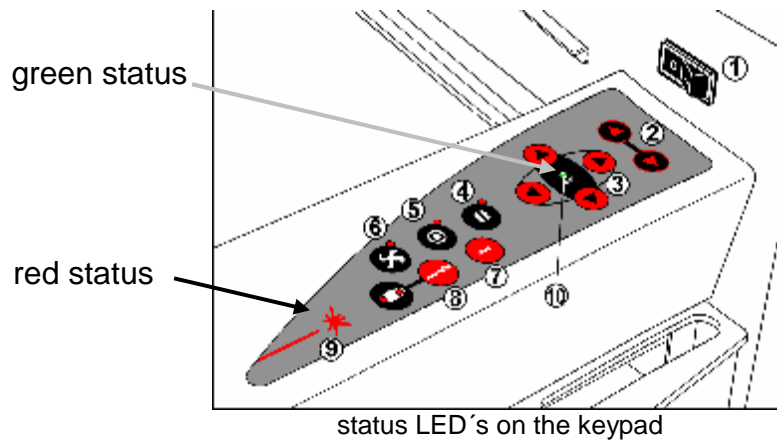

- Click on the symbols that are illuminated at the red status (of the lase LED [9])
- Read the error code

19. FAQ's

Frequently asked questions and their solution:

1. Problems you can see in the engraving result:

Problem description	Possible reason	Solution
too low engraving depth	lens upside down in the lens holder imprecise focussing dirty optics table misaligned too low laser power dirty beam output window on tube	turn round the lens check focus clean optics check table adjustment replace tube clean output window
blurred edges	lens upside down in the lens holder imprecise focussing table misaligned	turn round the lens check focus check table adjustment
bad shoulder angle	incorrect Edit settings imprecise focussing table misaligned lens upside down in the lens holder	adjust Edits check focus check table adjustment turn round the lens
missing cut lines	defect electronic board bad shoulder settings 0 passes in driver selected	replace board improve shoulder settings increase the amount of passes
shadows on the edges inconstant engraving depths wavyness of the lines	line thickness in Corel Draw too big tickle power too high table misaligned bad THK guide bad belt tension too high acceleraion settings	reduce line thickness to smallest possible value adjust tickle power adjust table replace guide check belt tensions reduce acceleration
no visible marking result	too low laser power too high velocity not focussed	increase power setting reduce velocity check focus
fine details on stamps are engraved too thin	incorrect Edit settings too steep shoulders	adjust edits reduce T, increase W

the upper part of the engravings is missing	outdated firmware version installed after closing of the door the job was started immediately	update firmware after closing the door wait 5 seconds to start the job
---	--	---

2. Machine malfunctions

Problem description	Possible reason	Solution
no referencing after start up	top door not closed defect in the interlock system mechanical problem on axis	close door check interlocks make sure that the mechanical resistance is small
no response at switching on of the system	bad limit switch defect power supply	replacement measure voltage, if necessary replace it
no communication to engraver connection to engraver breaks frequently	main fuses blown power supply defect invalid COM port selection serial cable defect electromagnetic imissions	replace fuses replace power supply change selection replace cable make sure that engraver and computer are connected to the same electric curcuit the original cable lenghts should not be exceeded
offsets between engraving jobs and cut lines	dusty encoder top speed too high acceleration too high	clean encoder reduce speed reduce acceleration

3. Noise generation

Problem description	Possible reason	Solution
noisy cooling fans	damaged ball bearings incorrect supply voltage old fan version	replace fan replace fan replace fan for NMB version
noisy table squeaking on movement in X-direction	outdated firmware version belt grips touch X-axis profile	update firmware move grips

faulty bearing	replace bearing
----------------	-----------------

4. Problems with the Software

Problem description	Possible reason	Solution
After installation it is not possible to send jobs to the manager the installation is terminated	directory names do not match the Windows 3.xx specifications incorrect serial number specified	make sure that names in the path do not exceed 7 characters please check the serial number in the directory INIfiles on the CD only here mentioned numbers will be accepted
missing material parameters	on installation „Custom“ and/or wattage was not selected	repeat the installation, install type custom make sure that the box that represents the correct wattage is checked
multiple positioning of jobs is not possible	selected job is already on the plate	select the job in the job queue click on
when clicking on start error messages occur	damaged trlog.vol file crowded Spool directory	

20. Recommended service intervals

For any service technician it's important to have information about the life expectancy of the different components.

The idea behind is to be able to decide whether a replacement is covered by the warranty or not. Please study the following information in detail. The warranty regulations are in every users manual, please refer in disputes to it.

Warranty Regulations

For devices of the laser product family Speedy and Power Laser PRO TROTEC Produktions- und VertriebsGmbH, Wels (hereinafter called "TROTEC") grants a warranty of 3 years from the date of purchase (datum of distribution) for devices of the laser product family Speedy and Power Laser PRO. During this time TROTEC will, according to your preference, replace all parts of those products, which by failure in material or design cause a failure of the readiness for operation, with a part of equal value or to repair it free of charge. Under warranty the cost of both parts and freight (standard freight) are covered by TROTEC.

TROTEC must be notified immediately if faults are noticed. Send the part in its original packaging to TROTEC or to a designated point of service and at TROTEC's discretion, customers receive a credit note for sending the replacement part. All replaced parts become property of TROTEC. Repair of failures does not extend the warranty obligation.

Wear-and-tear on parts is not covered by the warranty with the following exceptions; A warranty covers 1000 hours operating time for wear-and-tear on parts of motors (in particular replacement of brushes of the servo motors.). Optics (lenses and mirrors) are covered by a three-year warranty when an exhaust system from TROTEC is used, or if a different exhaust system is used and a certification of the flow capacity is presented immediately and certified by TROTEC in writing to be sufficient. The warranty for optics however is void if replacement is necessary due to insufficient or inappropriate cleaning (e.g. scratching during cleaning). (Typical image with optics damaged by inappropriate cleaning: Shooting through mirror or lens). The refilling of the laser tube with gas mixture is considered natural wear-and-tear and is not covered by the warranty. With wear-and-tear on parts, the warranty only covers damage that already existed at the time of distribution of the device, and was claimed immediately.

No warranty covers damage resulting from the following: Inappropriate handling, inadequate or inappropriate maintenance and cleaning, external influences (e.g. voltage fluctuations), operation and installation errors, transport damage, modifications, added parts and interference not performed by TROTEC authorized persons, use of unsuitable accessories or operating material.

Any improper use or modification of the devices without previous permission by TROTEC renders the warranty void. TROTEC is under no circumstances liable for the loss of profit, turnover, company value or expected cost-savings or special, direct or indirect damages resulting from the use or attempted use of the product, even if TROTEC has been advised of the possibility of such damages. TROTEC is also not liable for claims, being made by third parties against the customer. Therefore, in particular costs for third parties assigned without the explicit agreement of TROTEC and costs for replacement devices, cleaning and maintenance work will not be born.

TROTEC reserves the right to implement technical innovations as well as later changes to the warranty regulations. Place of performance and venue for both parties is Wels, the laws of the Republic of Austria apply exclusively.

Once again the main facts:

- Belts, gears, bearings, ball bearings and THK guide are not covered by the warranty.
- Laser tube: Whenever a damage of the tube occurs it is covered by the warranty only if it is a problem of the electronic components (e.g. if there is a sudden jump of laser power). If the tube needs a gas refill this is normal consumption and not covered.
When you send the defect tube back to Trotec we will check the problem cause and grant warranty if this is justified.
- X-axis motor: If the break down occurs after less than 1000 hours of operation (laser hours) the replacement is covered by the warranty.
- Optics: covered only if no scratches or other mechanical damages are discernible, the exhaust unit fits the requirements and the faulty units are shipped back to Trotec for inspection.

Recommended replacement intervals for wear-and-tear parts

Trotec recommends the below mentioned replacement intervals. The life time will in many cases be much longer. But as we want to prevent a loss of engraving precision wear-and-tear parts should be replaced regularly.

All mentioned hour ratings are laser hours.

Amount	Part no.	Part name	Replacement interval
		laser tube	when a problem occurs (expected after 2000h)
1	79758	Motor belt X-axis	1500h or 1year
1	79830	Motor belt Y-axis	2500h or 2years
1	80620	Main belt X-axis	1500h or 1year
1	80621	Main belt Y-axis	2500h or 2years
1	78330	Main belt Z-axis	4000h
1	79112	X-axis motor	1500h or 1year
1	80959	Y-axis motor	when a problem occurs
1	80958	Z-axis motor	when a problem occurs
2	79756	Ball bearings X-axis	1500h or 1year
2	79757		
4	79756	Ball bearings Y-axis	2500h or 2 years
4	79827		
6	79850	Ball bearings Z-axis	when a problem occurs
1	80735	Gearing assembly X-axis	1500h or 2years
1	79820	Gearing assembly Y-axis (left)	2500h or 3years
1	80962	Bearing assembly Y-axis	2000h
1	79828	Drive gear Y-axis	2500h
1	79814	THK guide X-axis	2500h
1	79832	THK guide Y-axis	3500h
1	75036	Mirror 1	when a problem occurs
1	79134	Mirror 2	when a problem occurs
1	79135	Mirror 3	when a problem occurs
1	74323	Lens	when a problem occurs

21. Recommended tools

service key (interlock defeat tool)
Allen key set inch
Allen key set metric
laser power meter
lens cleaner
lens tissue
spring balance 300g
laser protective goggles
electronic multimeter
tool box
magnifier 8x
engraving materials
set of screw drivers
set of screw drivers phillips
brushes in different sizes
paper tape
nomodem cable
PC datacable
side cutting pliers
combination pliers
adjustable wrench
small file, triangular
cutter knife
set of hexagon wrenches
adjustment plate for mirrors with
magnetic holder

22. Recommended spare parts Speedy - Starter Kit

CPU board	74327
Main board	74942
Motor Print	74943
Power supply 25W (two of them are used in a 50W speedy)	79706
mirror #1	75036
mirror #2	79134
mirror #3	79135
lens	74323
lens cleaner	69248
lens tissue	69249
X-axis motor	79112
Y-axis motor	79113
X-axis motor belt	79758
Y-axis motor belt	79830
fuses 2A	103970x10
fuses 1A	204708x10
fuses 6.3A	103976x10
fuses 0.2A	103962x10
ball bearing set X-axis (including bearings for gearset)	79757x2, 79756x2
ball bearing set Y-axis	79827x4, 79756x4
set of bearings for Y-axis (preassembled)	80962
brass adustment screws	79748x2
cooling fans laser tube	74945
set of safety warning labels	