

# SCHMIDT<sup>®</sup> Presses

Simply the best!

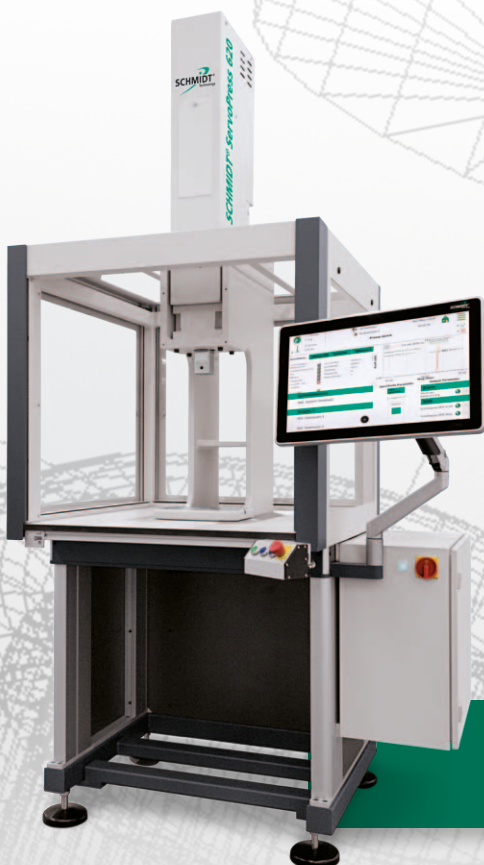
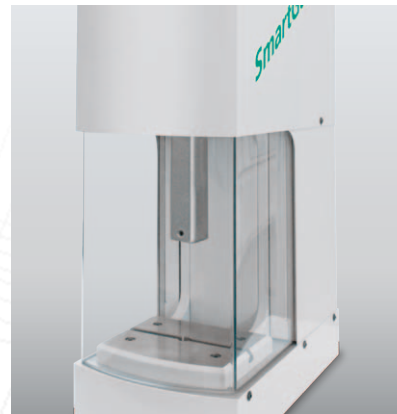

Presses, Control Units, Safety & more  
Complete solutions from a single source

# Table of Contents



<b>Introduction</b>	<b>I</b>
<b>ManualPress</b>	<b>II</b>
■ Rack-and-Pinion Presses	02
■ Toggle Presses	04
■ Nockenpresse 11N	10
■ ManualPress 305, 307, 311 with Process Monitoring	14
<b>Hydro-/Pneumatische Pressen</b>	<b>III</b>
■ PneumaticPress Direct Acting Presses	04
■ PneumaticPress Toggle Presses	08
■ PneumaticPress Force/Stroke Monitoring	12
■ HydroPneumaticPress C-Frame Design	18
■ HydroPneumaticPress Force/Stroke Monitor.	22
■ HydroPneumaticPress H-Frame Design	26
■ Cylinder Units	28
<b>Elektrische Pressen</b>	<b>IV</b>
■ ElectricPress	01
■ ServoPress	05
■ TorquePress	09
<b>Control Units</b>	<b>V</b>
■ PressControl 75	02
■ PressControl 700	03
■ PressControl 7000	04
■ Visualization & Process Analysis	06
■ Software Tools, PRC DataBase	07
■ PRC FileXchange	08
■ PRC DataXchange	09
■ PRC OpenFieldBus, PRC OPC	09
■ Hardware Tools	10
<b>Safety Concepts, Single Workstations</b>	<b>VI</b>
■ Single Workstations	01
■ SmartGate	02
■ SmartGuard	03
■ Classic Safety Concepts	04
■ Press Bases, Four-column Gantry	05
■ Slide Tables	06
■ Customer-Specific Solutions	07
■ Support	09
■ Service	10

# Family-Run Company

As internationally accepted Technology Leader



**SCHMIDT Technology** is a family-run, medium-sized enterprise at the highest technological level. The success speaks for itself: Today, products and services from **SCHMIDT Technology** are exported to over 80 countries of the world.

The safety and quality of **SCHMIDT Technology** products make them unique on the global market and thus sought after for decades. The international orientation of the company and the combination of creative and intelligent solutions, together with economic and efficient manufacturing in Germany, lay the groundwork for the successful future-oriented position of the enterprise.

Because of this, **SCHMIDT Technology** is valued internationally as a solid, dependable and competent partner. The outstanding characteristics of a successful company must include a strong visionary innovation potential.

**SCHMIDT Technology** recognized this at an early stage and invested ardently in the fields of research and development. At the same time, the company traditionally keeps in close contact with external research institutes and universities.

As a result, the name **SCHMIDT Technology** is associated with highest quality standards worldwide. In keeping with this, **SCHMIDT Technology** holds all relevant quality certificates such as DIN EN ISO 9001.

# Your profitability Is our top priority

Anyone who has to assemble two or more components must decide which assembly technology he wants to use. Traditional techniques such as screwing, welding, soldering and bond are being replaced, more and more, by cost-effective and rational pressing and joining operations for economic reasons.

These are exactly our strengths.



## Use our knowledge for your application

The right press type can be chosen depending on the application. Today, **SCHMIDT® Presses** stand for first-class assembly technology worldwide. This applies both for stand-alone machines and for assembly modules integrated in complex automation lines.

**SCHMIDT Technology** a leader in intelligent joining technology, has the widest product range of all producers. From **SCHMIDT® ServoPress** and **SCHMIDT® HydroPneumaticPress** or **SCHMIDT® PneumaticPress** and **SCHMIDT® ElectricPress** up to our **SCHMIDT® ManualPress** range, our solutions are tailored to meet all of your process requirements. Apart from the presses, the safety and control technology of the **SCHMIDT® PressesControl** sets standards due to its system philosophy, force/stroke monitoring and integrated measurement technology. A continuous process control and the essential ISO-conforming documentation are the tools for high productivity in today's efficient assembly. These performance features make **SCHMIDT Technology** the undisputed technological leader in the field of precision joining technology today.

This is the basis for the excellent reputation of **SCHMIDT Technology**, specifically in the key sectors such as automobile technology, aerospace technology, electrics/electronics, micro-mechanics and medical technology.

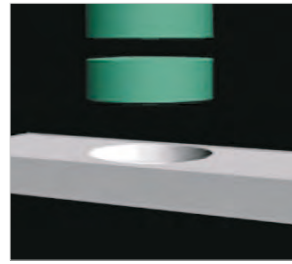

Pressing



Snap Fitting

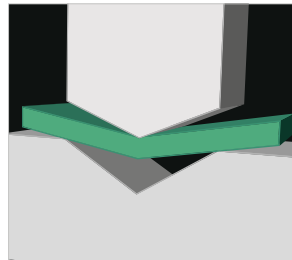

Forming

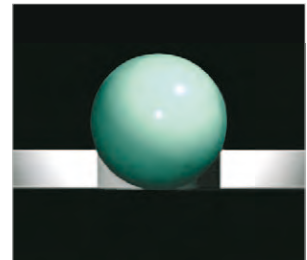

Forming Calibrating / Sizing

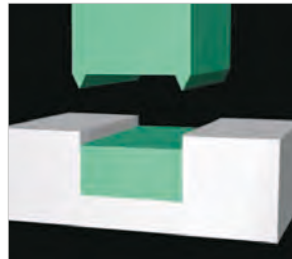

Crimping

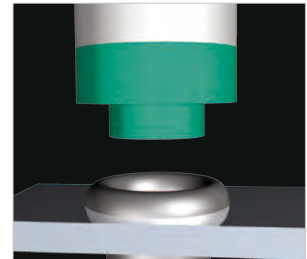

Flaring

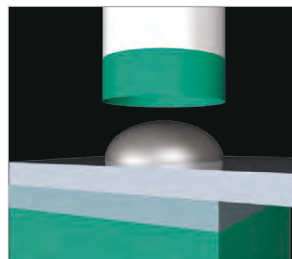

Riveting



Punching

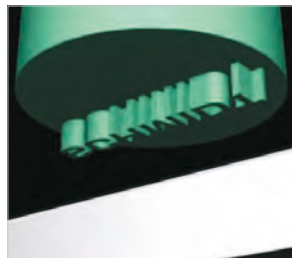

Marking

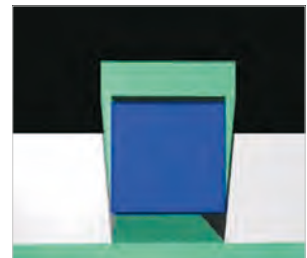

Cutting

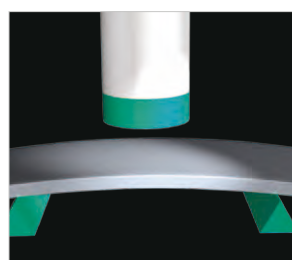

Bending

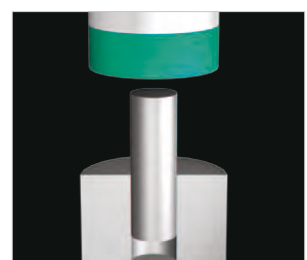

Joining

# In Partnership To success

A global market requires linked processes. Thanks to the OPC connection via Ethernet technology, you can access your process data at any time. Furthermore, local representation and rapid response are essential. Our worldwide distribution network of subsidiaries and trained sales & support partners ensure that our customers will receive full support for all their requirements. All our representatives' support teams have been trained specifically on our products.

Deciding in favour of our technology is the first step to a successful partnership.

The economic success is then shown in daily production. High quality products optimized for assembly processes are as important as an efficient after-sales service. Our name is your guarantee.



## Safety without compromise

In 2006, the EC Machine Directives became national law in the EU member states. The articles of this agreement were the determining factors for the design of safety controls for assembly and press technology. Furthermore, a EC type approval became necessary for applications with manual workstations.

Even before the most recent regulations became legally binding, **SCHMIDT Technology** had delivered all press systems in compliance with this new law to all its customers (even to countries where these regulations are not implemented).

Our philosophy does not allow making compromises with regard to safety and health of the user.

## Skills to your advantage

All our training centers provide machinery and full expertise to assist our customers with their applications.

On this basis, a team of skilled engineers plan economic solutions from the simple manual workstation to the fully automated assembly line.

Competent technical customer service is our strength. We offer training courses and seminars in our **SCHMIDT® TrainingCenters**. Your employees will achieve sustainable knowledge of the presses and their practical use resulting in a benefit for your products.



# SCHMIDT® ManualPress

## From 1.6 kN to 22 kN

Efficient manufacturing requires appropriate means of production – not always automation. In particular, with small production runs, manual presses are often the most cost effective solutions.

We are continually developing the range of manual presses so that you can achieve your production targets. The expertise we have gained from our exposure to numerous production applications has been implemented in our new models. Therefore, we can offer a wide range of manual presses to suit all requirements.

### Characteristics

- Flexibility
  - Rapid changeover due to the easy and secure adjustment of the working height
  - Table tops with precision T-slot and precise alignment between the ram and table bores allow for accurate and repeatable set ups which reduces set-up times
  - The original position of the hand lever can be varied by 360°
  - Horizontal pull (111/113)
  - Available for left-handed and right-handed use
  - The return stroke force of the ram can be adapted to different tool weights
- Precision
  - Alignment < 0.05 mm between upper and lower tool
- Maintenance-free
  - No lubrication necessary
- Long service life

Depending on the application, there is a wide selection of rack-and-pinion presses and toggle presses to choose from. Furthermore, a modular product design gives you the opportunity to choose the appropriate press for your application.



# SCHMIDT® Rack-and-Pinion Presses

## Constant force over the entire stroke

Do you need force over a longer stroke distance for assembly processes? Then **SCHMIDT® Rack-and Pinion Presses** are the right choice.

### Characteristics

- Long stroke
- Linear force progression
- Precise adjustment of the press depth via an integrated hardened adjustable stop
- Honed ram guiding and ground rams provide a long service life and a precise guidance



Press Type 5



Press Type 3 or 6



Press Type 1 or 2



Improved return stroke mechanism for rack-and-pinion presses No. 3 and 6 with stroke 100 mm and 160 mm

The use of a spring package optimized specifically for large strokes improves ergonomics significantly. In addition, the use of the **Ergohandle** ensures that even with angles of rotation  $>360^\circ$  no hand position switching of is necessary. The force feedback on the hand lever is kept as constant as possible over the entire stroke by a balance weight.



### Press Head

No.1 and No.2 have a ground guidance plate and teflon-coated adjustable gibs for precise and torsion-proof guidance.

## From 1.6 kN to 2.5 kN

Press Type		5	5R	3	3R	6	6R	1	1R	2	2R
<b>Press head type</b>		5	5R	3	3R	3	3R	1	1R	1	1R
Nominal force	kN	1.6	1.6	2.4	2.4	2.4	2.4	2.5	2.5	2.5	2.5
Working stroke	A mm	40	40	70	70	70	70	80	80	80	80
				160	100	160	100	100	100	100	100
Press head height	S mm	240	240	350	350	350	350	400	400	400	400
				350	350	350	350				
Throat depth	C mm	65	65	86	86	86	86	86	86	86	86
Ram bore	Ø mm	10H7	10H7	10H7	10H7	10H7	10H7				
Collet (standard Ø10)	Ø mm							1-17	1-17	1-17	1-17
Hand lever left		○	○	○	○	○	○	●	●	●	●
Angle of rotation/mm stroke		4.1°	4.1°	3.2°	3.2°	3.2°	3.2°	2.2°	2.2°	2.2°	2.2°
Max. weight of the upper tool <sup>2)</sup>	kg	1.5	1.0	2.5	2.0	2.5	2.0	1.0	1.0	1.0	1.0
<b>Return stroke lock<sup>1)</sup></b>											
Minimum working stroke	mm		17		18		18		26		26
Locked position 1	mm bef. BDC		11.5		13		13		19.5		19.5
Locked position 2	mm bef. BDC		3.5		4.5		4.5		7		7
Disengaging accuracy	mm		0.06		0.07		0.07		0.08		0.08
<b>Working height<sup>3)</sup></b>	F										
Frame No. 13	mm	55-200	55-200					120-260	120-260		
Frame No. 3	mm			75-220	75-220						
Frame No. 2	mm					100-355	100-355			145-360	145-360
Frame No. 2-600 ○	mm			200-600	200-600	200-600	200-600	245-650	245-650	245-650	245-650
Frame No. 2-1000 ○	mm			330-1030	330-1030	330-1030	330-1030	380-1080	380-1080	380-1080	380-1080
Weight	approx. kg	11	11	22	22	30	30	23	23	31	31

Accessories	5	5R	3	3R	6	6R	1	1R	2	2R
Mechanical counter	○	○	○	○	○	○	○	○	○	○
Throat depth frame (total depth) 111 mm, 131 mm, 160 mm, 200 mm			○	○	○	○	○	○	○	○
Additional fixture mounting plate suitable for throat depth frame			○	○	○	○	○	○	○	○
Micrometer stop	○	○	○	○	○	○				

Frame Overview	Press Type	Frame Height M without height adj. (mm)	Table Size B x T (mm)	Table Bore D (Ø mm)	Table Height K (mm)	Mounting Surface B x L (mm)
No. 13	5	330	110 x 80	20H7	46	110 x 185
No. 3	3, 1	400	150 x 110	20H7	60	150 x 260
No. 2	6, 2	536	185 x 110	20H7	60	185 x 280
No. 2-600	3, 6, 1, 2	810	200 x 160	20H7	98	200 x 290
No. 2-1000	3, 6, 1, 2	1250	200 x 160	20H7	98	200 x 290

### Options

- Series with no additional charge ○ Additional charge applies
- <sup>1)</sup> Adjustment of locking position on request
- <sup>2)</sup> The weight was determined with hand lever position 45° forward (guide)
- <sup>3)</sup> Typical values; can vary ± 3 mm due to casting and production tolerances

### Other available options

- Nickel plated – cast parts are electroless nickel plated, steel components black oxide finished, aluminum anodized, precision steel surfaces are untreated
- Custom paint – press and column can be painted to customer's color specification
- Bores for adapting tooling – customer specific sizes can be supplied

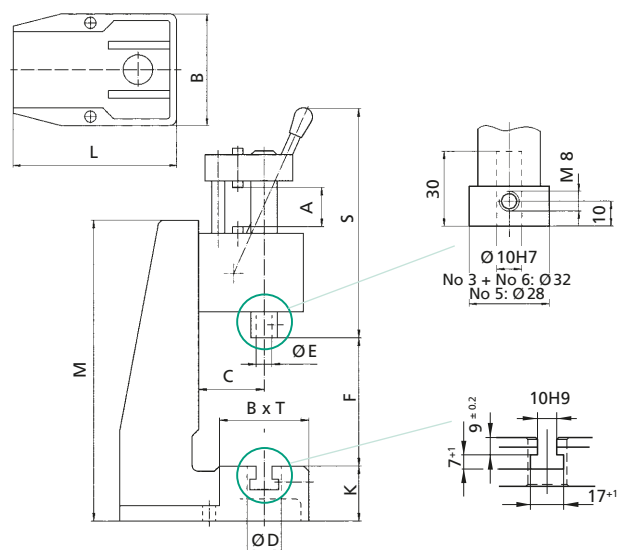
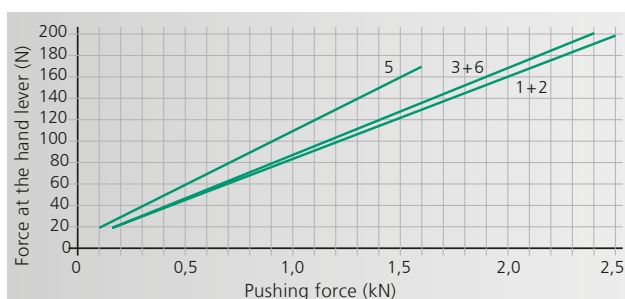

Detailed dimensional drawings can be downloaded: [www.schmidttechnology.de](http://www.schmidttechnology.de)



# SCHMIDT® Toggle Presses

The high force at the end of stroke, just where it is important

Do you need a high force at the end of stroke for material transforming processes? Then **SCHMIDT® Toggle Presses** are just the right choice.

## Characteristics

- High force at the end of stroke (see diagram below)
- Honed bores and ground rams provide a long service life and a precise guidance



Press Type 13RFZ



Press Type 11/14 -17R

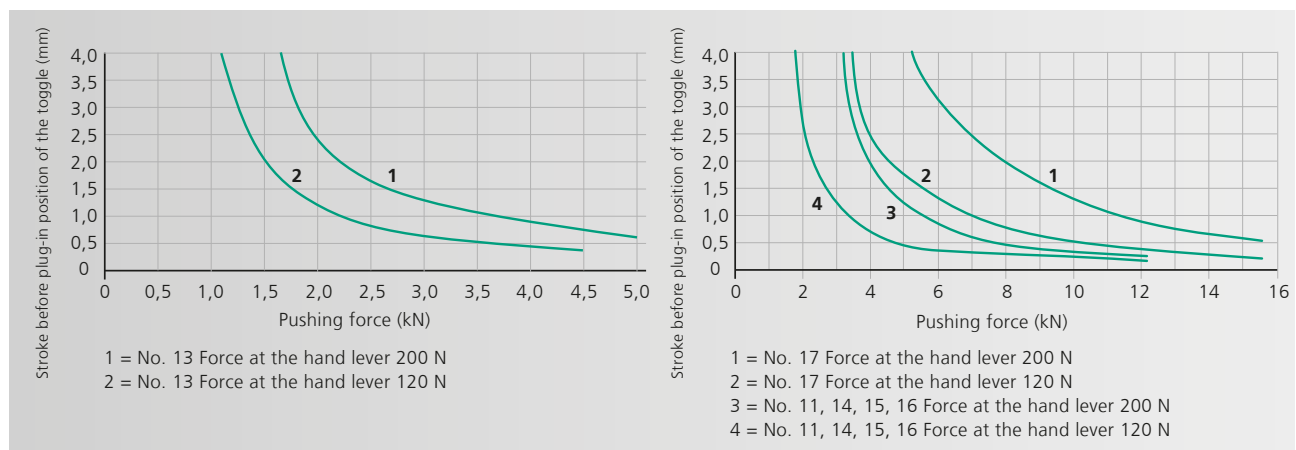

Maximum force will be reached just before extended position

## From 5 kN to 15 kN

Press Type			13 13F	13R 13RF	11 11F	11R 11RF	15 15F	15R 15RF	14 14F	14R 14RF	16 16F	16R 16RF	17 17F
Press head type			13-40 13F-35	13R-40 13RF-35	11-45 11F-35	11R-45 11RF-35	11R-45 11F-35	11R-45 11RF-35	11-60 11F-50	11R-60 11RF-50	11-60 11F-50	11R-60 11RF-50	11-20 11F-20
Nominal force		kN	5	5	12	12	12	12	12	12	12	12	15
Working stroke	A	mm	40 35	40 35	45 35	45 35 <sup>5)</sup>	45 35 <sup>5)</sup>	45 35 <sup>5)</sup>	60 50	60 50	60 50	60 50	20 20 <sup>5)</sup>
Throat depth	C	mm	65	65	86	86	86	86	86	86	86	86	86
Press head height	S	mm	385 400	385 400	520 540	520 540	520 540	520 540	500 520	500 520	500 520	500 520	620 640
Ram bore	Ø	mm	10H7	10H7	10H7	10H7	10H7	10H7	10H7	10H7	10H7	10H7	10H7
Hand lever left			o		o		o		o		o		
Angle of rotation			95°	95°	110°	110°	110°	110°	125°	125°	125°	125°	90°
Max. weight upper tool <sup>3)</sup>		kg	1.2/3.5 1.5/3	1.2/3.5 1.5/3	2/4.5 2.5/6	2/4 2/6	2/4.5 2.5/6	2/4 2/6	1.5/2.5 2/5	1.5/2.5 1.5/4	1.5/2.5 2/5	1.5/2.5 1.5/4	2.5/- 2.5/-
<b>Return stroke lock<sup>1)</sup></b>													
Minimum working stroke		mm		25		20		20		24		24	
Locked position 1		mm bef. DC		13.5		12		12		14		14	
Locked position 2		mm bef. DC		1.5		1.5		1.5		1.5		1.5	
Disengaging accuracy		mm		0.03		0.03		0.03		0.04		0.04	
<b>Working height<sup>4)</sup></b>	F												
Frame No. 13		mm	65-180 40-155	65-180 40-155									
Frame No. 3		mm			75-210 50-185	75-210 50-185			90-220 65-195	90-220 65-195			65-200 50-185
Frame No. 5													65-315 50-300
Frame No. 2		mm					100-345 80-325	100-345 80-325			110-360 85-335	110-365 85-335	
Frame No. 2-600 o		mm			200-585 175-560	200-585 175-560	200-585 175-560	200-585 175-560	210-595 185-570	210-595 185-570	210-595 185-570	210-595 185-570	190-575 175-560
Frame No. 2-1000 o		mm			330-1020 305-1000	330-1020 305-1000	330-1020 305-1000	330-1020 305-1000	340-1030 315-1010	340-1030 315-1010	340-1030 315-1010	340-1030 315-1010	315-1015 300-1000
Weight		approx. kg	12	12	23	24	29	29	24	24	29	29	23

Accessories	13 13F	13R 13RF	11 11F	11R 11RF	15 15F	15R 15RF	14 14F	14R 14RF	16 16F	16R 16RF	17 17F
Mechanical counter	o	o	o	o	o	o	o	o	o	o	o
Throat depth frame (total depth) 111 mm, 131 mm			o	o	o	o	o	o	o	o	o
Additional fixture mounting plate suitable for throat depth frame			•	•	•	•	•	•	•	•	•
Block clamping piece <sup>2)</sup>	o o	o o	• •	• •	• •	• •	• •	• •	• •	• •	• •

Frame Overview	Press Type	Frame Height M (mm)	Table Size B x T (mm)	Table Bore D (Ø mm)	Table Height K (mm)	Mounting Surface B x L (mm)
No. 13	13	475	110 x 80	20H7	46	110 x 185
No. 3	11, 14, 17	540	150 x 110	20H7	60	150 x 260
No. 5	17	536	185 x 110	20H7	60	185 x 275
No. 2	15, 16	700	185 x 110	20H7	60	185 x 280
No. 2-600	11, 14, 15, 16, 17	974	200 x 160	20H7	98	200 x 290
No. 2-1000	11, 14, 15, 16, 17	1410	200 x 160	20H7	98	200 x 290

### Options

- Series with no additional charge o Additional charge applies
- <sup>1)</sup> Adjustment of locking position on request
- <sup>2)</sup> Stroke reduction about 10 mm by version with additional charge
- <sup>3)</sup> The weight was determined with hand lever position 45° forward (guide)
- <sup>4)</sup> Typical values; can vary ± 3 mm due to casting and production tolerances
- <sup>5)</sup> Stroke adjustable with stop clamp (in the scope of delivery)

### Other available Options

- Nickel plated – cast parts are electroless nickel plated, steel components black oxide finished, aluminum anodized, precision steel surfaces are untreated
- Custom paint – press and column can be painted to customer's color specification
- Bores for adapting tooling – customer specific sizes can be supplied

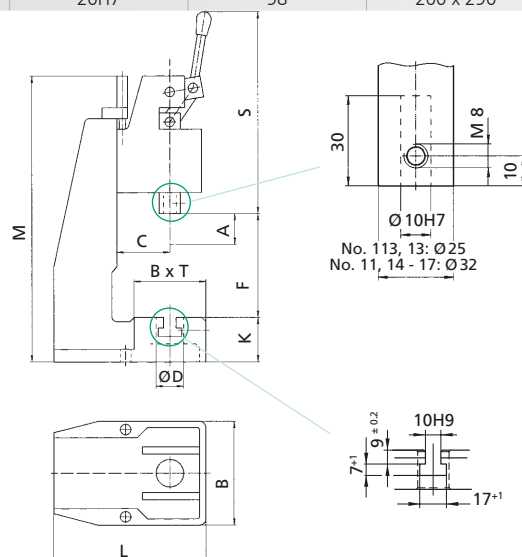

Detailed dimensional drawings can be downloaded: [www.schmidttechnology.de](http://www.schmidttechnology.de)

# SCHMIDT® Toggle Presses with Horizontal Pull

## The high force at the end of stroke, just where it is important

Do you need a high force at the end of stroke for material transforming processes? Then **SCHMIDT® Toggle Presses** are just the right choice.

### Characteristics

- High force at the end of stroke (see diagram below)
- Honed bores and ground rams provide a long service life and a precise guidance



Press Type 113RFZ



Press Type 111RF

### Ergonomic Press with horizontal pull

With press No. 113 and No. 111 the manual force is applied by pulling the lever towards the body. This press is especially suitable for rapid production at small forces. We supply press No. 111 including the ergonomic handle (standard scope of supply).

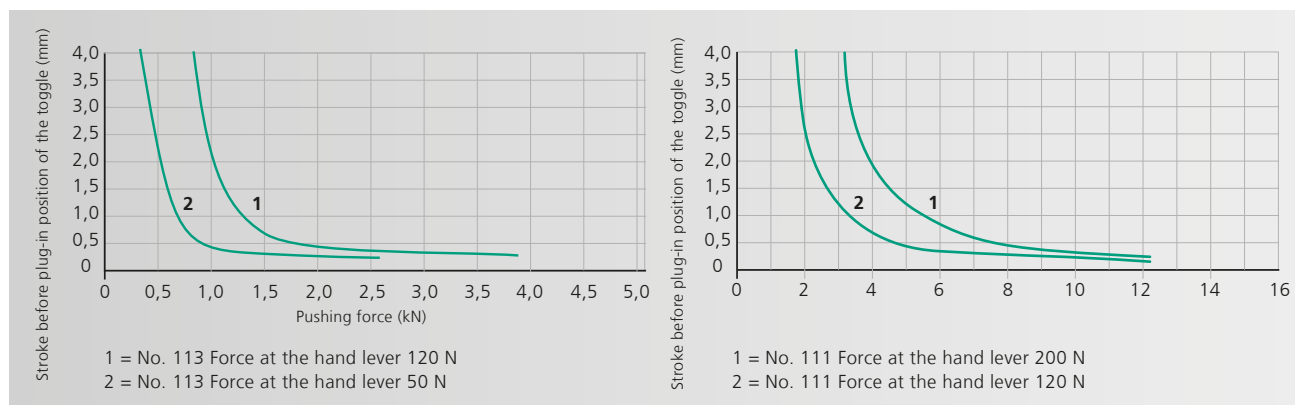

Maximum force will be reached just before extended position

## From 2.5 kN to 12 kN

Press Type			113 113F	113R 113RF	111 111F	111R 111RF
<b>Press head type</b>			113 113F	113R 113RF	111 - 45 111F - 50	111R - 45 111RF - 50
Nominal force		kN	2.5	2.5	12	12
Working stroke <sup>5)</sup>	<b>A</b>	mm	28 28	28 28	45 50	45 50
Throat depth	<b>C</b>	mm	65	65	86	86
Press head height	<b>S</b>	mm	170 180	190 200	215 225	240 250
Ram bore	∅	mm	10H7	10H7	10H7	10H7
Hand lever left			-	-	-	-
Angle of rotation			80°	80°	90°	90°
Max. weight upper tool <sup>3)</sup>		kg	1/3 0.6/3	0.5/2.5 0.6/3	2.5/- 3/-	2.5/- 3/-
<b>Return stroke lock<sup>1)</sup></b>						
Minimum working stroke		mm		22		24
Locked position 1		mm bef. BDC		12		14
Locked position 2		mm bef. BDC		0.5		1.5
Disengaging accuracy		mm		0.03		0.07
<b>Working height<sup>4)</sup></b>						
Frame No. 13		mm	50-165 40-155	50-165 40-155		
Frame No. 3		mm			120-205 105-195	120-205 105-195
Frame No. 2		mm			120-345 105-335	120-345 105-335
Frame No. 2-600 ○		mm			200-580 185-570	200-580 185-570
Frame No. 2-1000 ○		mm			330-1020 310-1000	330-1020 310-1000
Weight		approx. kg	11	11	28	28

Accessories	113 113F	113R 113RF	111 111F	111R 111RF
Mechanical counter	○	○	○	○
Throat depth frame (total depth) 111 mm, 131 mm			○	○
Additional fixture mounting plate suitable for throat depth frame			○	○
Block clamping piece <sup>2)</sup>	● ○	● ○	● ○	● ○

Frame Overview	Press Type	Frame Height M (mm)	Table Size B x T (mm)	Table Bore D (∅ mm)	Table Height K (mm)	Mounting Surface B x L (mm)
No. 13	113	475	110 x 80	20H7	46	110 x 185
No. 3	111	540	150 x 110	20H7	60	150 x 260
No. 2	111	700	185 x 110	20H7	60	185 x 280
No. 2-600	111	974	200 x 160	20H7	98	200 x 290
No. 2-1000	111	1410	200 x 160	20H7	98	200 x 290

### Options

- Series with no additional charge ○ Additional charge applies
- <sup>1)</sup> Adjustment of locking position on request
- <sup>2)</sup> Stroke reduction about 10 mm by version with additional charge
- <sup>3)</sup> The weight was determined with hand lever position 45° back (guide)
- <sup>4)</sup> Typical values; can vary ± 3 mm due to casting and production tolerances
- <sup>5)</sup> Stroke adjustable with stop clamp (in the scope of delivery)

### Other available options

- Nickel plated – cast parts are electroless nickel plated, steel components black oxide finished, aluminum anodized, precision steel surfaces are untreated
- Custom Paint – Press and column can be painted to customer's color specification
- Bores for adapting tooling – customer specific sizes

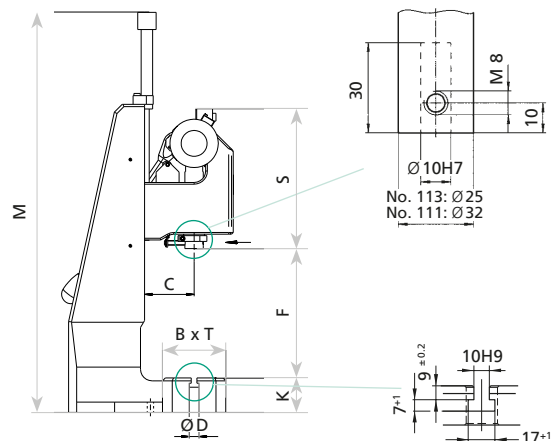
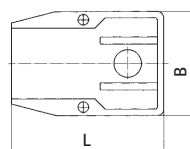

Detailed dimensional drawings can be downloaded: [www.schmidttechnology.de](http://www.schmidttechnology.de)

# SCHMIDT® Toggle Presses with Square Ram

## Optimum guidance and anti-rotation

Do you need a high force at the end of stroke for material-transforming processes? Then **SCHMIDT® Toggle Presses** are just the right choice.

### Characteristics

- High force at the end of stroke
- Square ram is anti-rotational (no die sets required)
- Fully adjustable, play-free teflon-lined gibs



Press Type 11 VRZ  
13 VRZ  
14 VRZ

Press Type 15 VF  
16 VF

Press Type 19 VF

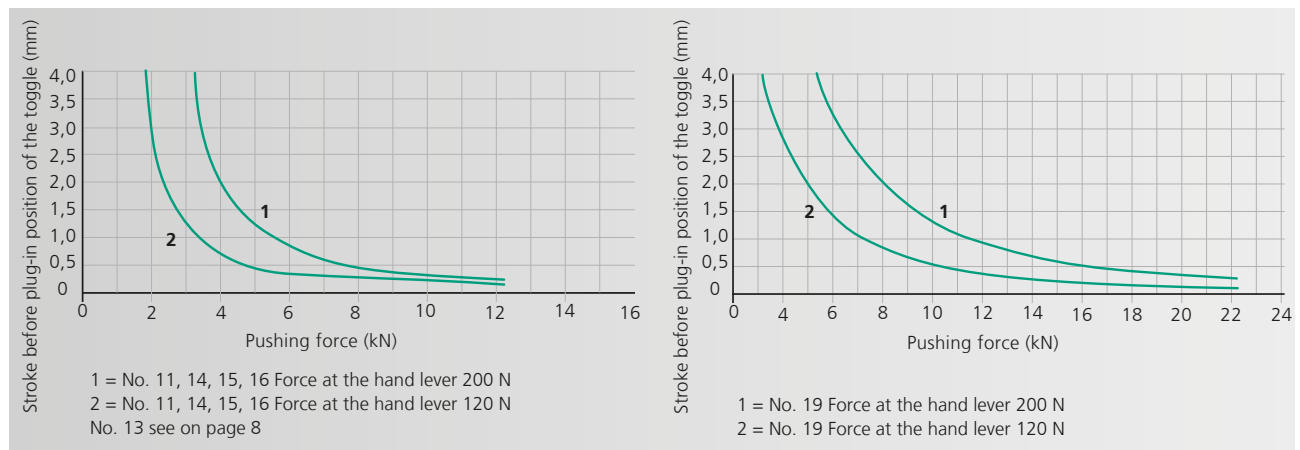

Maximum force will be reached just before extended position

## From 5 kN to 22 kN

Press Type		13 V 13 VF	13 VR 13 VRF	11 V 11 VF	15 V 15 VF	11 VR 11 VRF	15 VR 15 VRF	14 V 14 VF	16 V 16 VF	14 VR 14 VRF	16 VR 16 VRF	19 V 19 VF	19 VR 19 VRF	
<b>Press head type</b>		13V-40 13VF-40	13VR-40 13VRF-40	11V-45 11VF-45	11V-45 11VF-45	11VR-45 11VRF-45	11VR-45 11VRF-45	11V-60 11VF-60	11V-60 11VF-60	11VR-60 11VRF-60	11VR-60 11VRF-60	19V-40 <sup>1)</sup>	19VR-40 <sup>1)</sup>	
Nominal force	kN	5	5	12	12	12	12	12	12	12	12	22	22	
Working stroke <sup>5)</sup>	A	mm	40	40	45	45	45	45	60	60	60	60	40	40
			40	40	45	45	45	45	60	60	60	60	40	40
Throat depth	C	mm	65	65	86	86	86	86	86	86	86	131	131	
Press head height	S	mm	385	385	510	510	510	510	510	510	510	620	620	
			400	400	530	530	530	530	530	530	530	620	620	
Ram bore	Ø	mm	10H7	10H7	10H7	10H7	10H7	10H7	10H7	10H7	10H7	20H7	20H7	
Hand lever left			○		○	○		○	○			●	●	
Angle of rotation			95°	95°	110°	110°	110°	110°	125°	125°	125°	125°	175°	175°
Max. weight top tool <sup>3)</sup>	kg	1.2/4	1.2/4	1.6/4.2	1.6/4.2	1.6/4.2	1.6/4.2	1/3.5	1/3.5	1/3.5	1/3.5	2/-	2/-	
		2/3.5	2/3.5	2/5	2/5	2/5	2/5	1/3.5	1/3.5	1/3.5	1/3.5	2/-	2/-	
<b>Return stroke lock<sup>2)</sup></b>														
Minimum working stroke	mm		26			20	20			28	28		10	
Locked position 1	mm bef. BDC		14.5			12	12			14	14		4.5	
Locked position 2	mm bef. BDC		1.5			1.5	1.5			1.5	1.5		0.9	
Disengaging accuracy	mm		0.03			0.03	0.03			0.04	0.04		0.02	
<b>Working height<sup>4)</sup></b>	F													
Frame No. 13	mm	65-180 50-165	65-180 50-165											
Frame No. 3	mm			80-210 60-190		80-210 60-190		80-210 60-190		80-210 60-190				
Frame No. 2	mm				105-350 85-330		105-350 85-330		105-350 85-330		105-350 85-330			
Frame No. 2-600 ○	mm				200-585 185-570		200-585 185-570		210-590 195-575		210-590 195-575			
Frame No. 2-1000 ○	mm				330-1020 315-1000		330-1020 315-1000		340-1030 325-1015		340-1030 325-1015			
Frame No. 19	mm											90-220	90-220	
Frame No. 19-400 ○	mm											160-400	160-400	
Frame No. 19-500 ○	mm											260-550	260-550	
Weight	approx. kg	12	12	24	32	24	32	24	32	24	32	85	85	
Accessories		13 V 13 VF	13 VR 13 VRF	11 V 11 VF	15 V 15 VF	11 VR 11 VRF	15 VR 15 VRF	14 V 14 VF	16 V 16 VF	14 VR 14 VRF	16 VR 16 VRF	19 V 19 VF	19 VR 19 VRF	
Mechanical counter		○	○	○	○	○	○	○	○	○	○	○	○	
Throat depth frame 111 mm, 131 mm				○	○	○	○	○	○	○				
Throat depth frame 151 mm												○	○	
Additional fixture mounting plate suitable for throat depth frame				○	○	○	○	○	○	○	○	○	○	
Frame Overview		Press Type	Frame Height M (mm)	Table Size B x T (mm)	Table Bore D (Ø mm)	Table Height K (mm)	Mounting Surface B x L (mm)							
No. 13		13	475	110 x 80	20H7	46	110 x 85							
No. 3		11, 14	540	150 x 110	20H7	60	150 x 260							
No. 2		15, 16	700	185 x 110	20H7	60	185 x 280							
No. 2-600 ○		15, 16	974	200 x 160	20H7	98	200 x 290							
No. 2-1000 ○		15, 16	1410	200 x 160	20H7	98	200 x 290							
No. 19		19	640	200 x 160	25H7	112	200 x 370							
No. 19-400 ○		19	840	250 x 200	40H7	145	250 x 460							
No. 19-500 ○		19	1000	250 x 200	40H7	145	250 x 480							

### Options

- Series with no additional charge ○ Additional charge applies
- <sup>1)</sup> Special strokes 12 mm and 50 mm on request
- <sup>2)</sup> Adjustment of locking position on request
- <sup>3)</sup> The weight was determined with hand lever position 45° forward (guide)
- <sup>4)</sup> Typical values; can vary ± 3 mm due to casting and production tolerances
- <sup>5)</sup> Stroke adjustable with stop clamp (in the scope of delivery)

### Other available options

- Nickel plated – cast parts are electroless nickel plated, steel components black oxide finished, aluminum anodized, precision steel surfaces are untreated
- Custom Paint – Press and column can be painted to customer's color specification
- Bores for adapting tooling – customer specific sizes

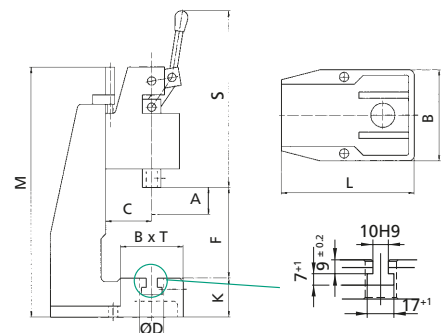

Detailed dimensional drawings can be downloaded: [www.schmidttechnology.de](http://www.schmidttechnology.de)

# SCHMIDT® CamPress 11N

The best of both worlds

We have merged the best features of the two hand lever press types, the toggle press and the rack and pinion press, and combined them in the **SCHMIDT® CamPress 11N**. Thanks to this clever mechanism, the patented assembly press is characterized by a particularly smooth operation and strong force at the end of the stroke. The sophisticated mechanics make the manual CamPress 11N particularly ergonomic and user-friendly.

This unique motion creates a high, linear force progression with high breakaway torque at the beginning of the ram movement and a steep force increase at the end of the stroke; and all this with constant hand force.

The use of the balance weights and the ErgoHandle ensures a smooth motion process and ergonomic operation of the hand lever. Both components and height adjustment with the crank lever are part of the standard scope of delivery. Of course, the proven options such as return stroke lock, fine adjustment and mechanical counter can also be used here.

**SCHMIDT® CamPress 11N**  
with return stroke lock and  
fine adjustment



Balance weight and  
ErgoHandle for  
ergonomic operation  
of the hand lever

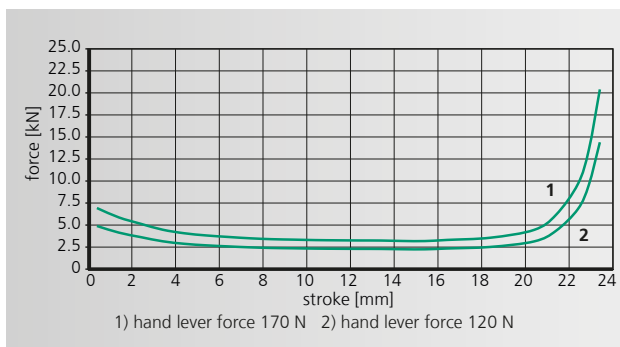

# SCHMIDT® CamPress 11N

## Examples of process-safe workstations

Press Typ		11N	11NF
Press head type		11N-23	11NF-23
Nominal force		kN	20
Working stroke		A mm	23
Throat		C mm	86
Head height		S mm	458
Ram bore		Ø mm	10H7
Hand level left			
Rotation angle / stroke		°	180
Max. weight upper tool <sup>3)</sup>		kg	2
Return stroke lock <sup>2)</sup>			
Minimum working stroke		mm	10.3
Locked position 1		mm bef. BDC	12.7
Locked position 2		mm bef. BDC	1.8
Disengaging accuracy		mm	0.05
Working height <sup>4)</sup>		F	
Frame No 5		mm	75 – 320
Weight		~ kg	55 – 300
			40

Option		11N	11NF
Mechanical counter			o

Overview frame	Press Typ	Frame height M (mm)	Table size B x T (mm)	Table bore D (Ø mm)	Table height K (mm)	Footprint B x L (mm)
Nr. 5	11N	587	185 x 110	20H7	60	185 x 273

### Options

- Series with no additional charge ○ Additional charge applies
- <sup>2)</sup> Adjustment of locking position on request
- <sup>3)</sup> The weight was determined with hand lever position 45° forward (guide)
- <sup>4)</sup> Typical values; can vary ± 3 mm due to casting and production tolerances

### Other available options

- Nickel plated – cast parts are electroless nickel plated, steel components black oxide finished, aluminum anodized, precision steel surfaces are untreated
- Custom paint – press and column can be painted to customer's color specification
- Bores for adapting tooling – customer specific sizes

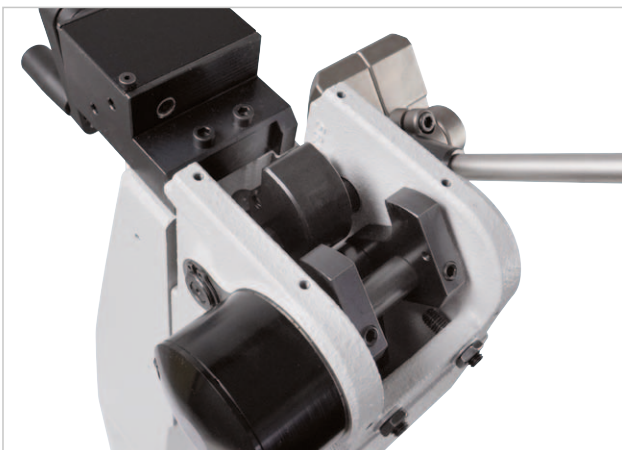

Patented mechanics with high force at the end of the stroke

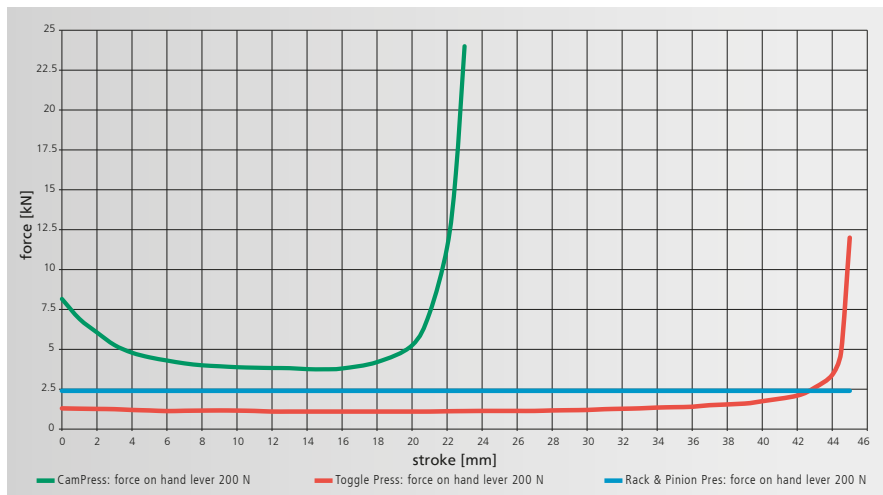

CamPress 11N in comparison to Toggle Press and Rack and Pinion Press

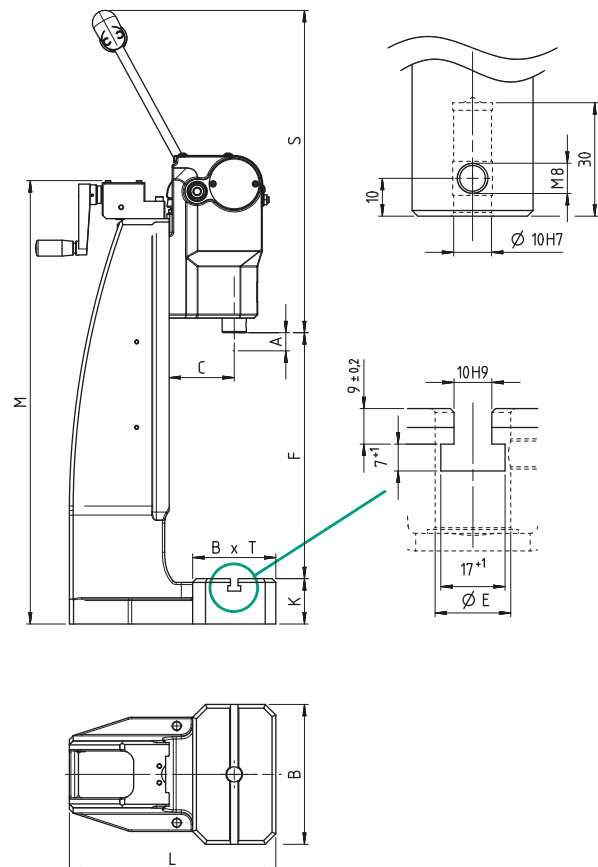



# SCHMIDT® ManualPress

Options suitable for your application

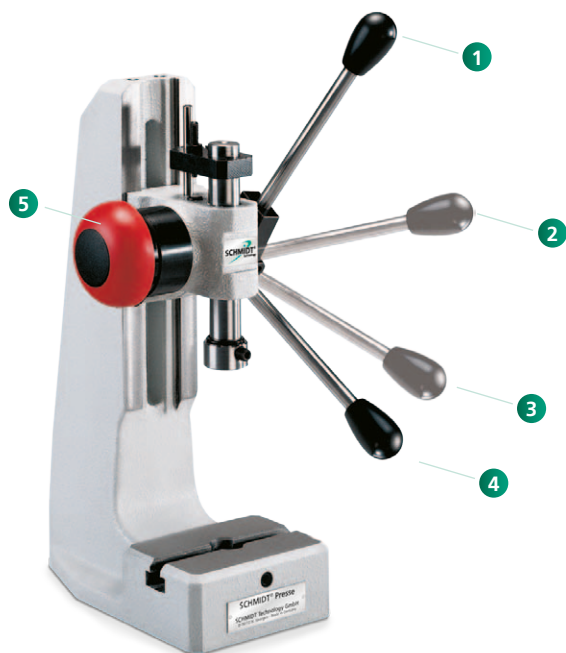

The return stroke lock guarantees reaching the required pressing depth with every stroke

- 1 TDC (Top Dead Center) position
- 2 First locking position: Loose tools can still be aligned
- 3 Second locking position before BDC (Bottom Dead Center). From here you can only continue to BDC.
- 4 After reaching BDC (Bottom Dead Center) and completing the stroke the return stroke lock is released. This guarantees a repeatable BDC and thus a constant press depth
- 5 The emergency button releases the locking function in any position



Fine adjustment with micrometer scale serves as stop for the rack and pinion presses

An optional micrometer adjustable stop developed specifically for applications that need fine adjustment of the BDC. The robust and precise design ensures the repeatability of the stop, no matter how many strokes are taken.

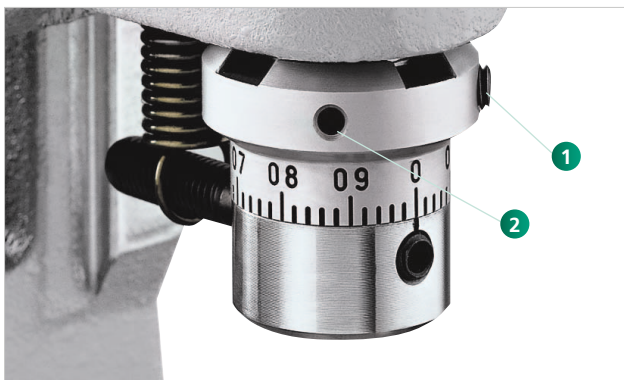

Fine adjustment with micrometer scale for toggle presses

By loosening the set screw 1 and turning the adjusting nut 2 with the same tool, the setting of the BDC can be adjusted infinitely. The adjustment in a range of  $\frac{1}{100}$  of a mm is reached rapidly and precisely.

# SCHMIDT® ManualPress

## Options suitable for your application



**Mechanical counter**  
A four digit counter monitors the number of pieces produced. The counter is provided with a reset function.



**Collet**  
For the rack-and-pinion presses No. 1 and No. 2, collet bore diameter of 1 to 17 mm.



**Throat extension block**  
We offer various sizes for extended throat depths.



**Special fixture mounting plates**  
Special fixture tabletops, designed in conjunction with throat extension blocks, provide ram to table bore alignment when spacer is used.



**Ergonomic left-handed design**  
With most press types, lefthanded or left-/right-handed design is an available option.

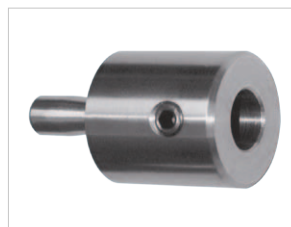

**Upper tooling adapter**  
Adapter for tools with a diameter of 5 - 20 mm.



**Nickel plated design**  
Press frames and cast parts are electroless nickel-plated, steel components are black oxide finished, aluminum parts are anodized, precision steel surfaces are untreated.



**Ergonomic handle**  
Swivelling handle for improved comfort; easy and flexible assembly on the hand lever.



**Press base**  
Plastic (250 x 340 mm), including fasteners.



**Stop clamp**  
For Toggle Presses.

### How to order

#### Order key for press options

R = incl. return stroke lock with emergency release  
F = incl. fine adjustment with micrometer scale  
Z = incl. mechanical counter  
RF= incl. return stroke lock with emergency release and fine adjustment

### Order example

No. 3 R = **SCHMIDT® Rack-and-Pinion Press No. 3**  
incl. return stroke lock with emergency release

or

No. 13 RFZ = **SCHMIDT® Toggle Press No. 13**  
incl. return stroke lock with emergency release, fine adjustment and mechanical counter

# SCHMIDT® ManualPress 300 Series

## Manual Presses with Process Monitoring

Process reliability, force/stroke monitoring of the joining process and EN ISO-compatible documentation of the results are becoming the major factors for small and medium production within the manual workplace.

**Process reliability – not just a slogan**

The system software allows easy setup of quality control criteria for 100 % in-process monitoring.

The **SCHMIDT® ManualPress 300 Series** system with **SCHMIDT® PressControl 700** includes:

- Integrated reliable measuring technology
- High resolution of the obtained process data
- Graphical and numerical output of the processing results
- Quality monitoring using freely selectable tolerances



Assembly system with patented return stroke lock and programmable clutch.

# SCHMIDT® ManualPress 300 Series

Process reliability for manual workplaces, force range 0.4 kN to 12 kN

## Characteristics

- Linear force progression for No. 305 and No. 307
- High force at the end of stroke for No. 311
- Precise adjustment of the press depth via micrometer fine adjustment
- Guides require little maintenance, have little wear and are locked against rotation. This results in precise working and a long service life
- Optimum guidance and clamping due to dovetail guide on the press head
- Quick set-up
  - Exact alignment of ram bore to the table within 0.05 mm
  - Height adjustment using a crank
  - Precision bores in ram and column base plate

## Functional components

- Electronic stroke lock
- Integrated transducer
  - Force sensor
  - Incremental encoder
- Integrated signal amplifier
- Programmable overload coupling

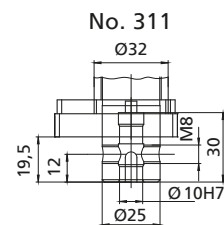
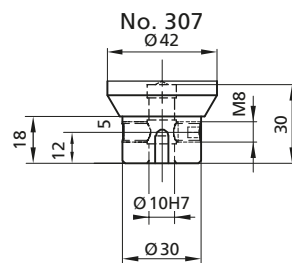
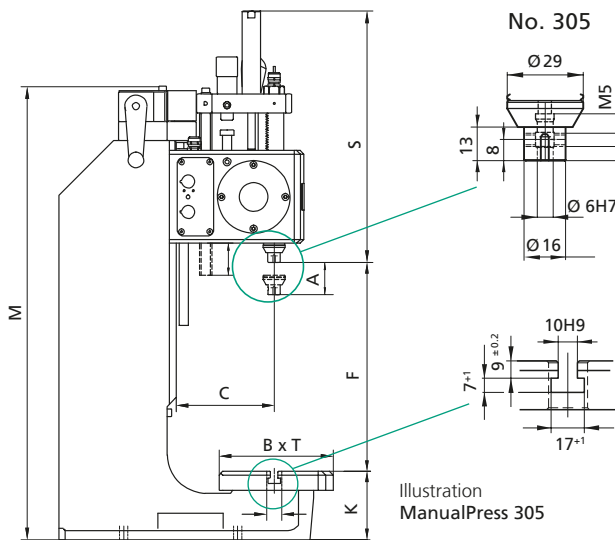
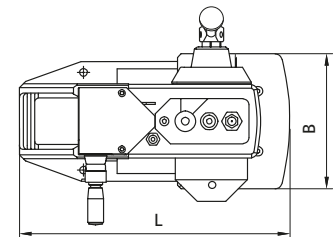

Press Type		305	307	311
Nominal force	kN	0.4	4	12
Force at the hand lever	approx. N	50	200	200
Working stroke	A mm	42	54	50
Throat depth	C mm	129	129	129
Press head height	S mm	310	417	555
Ram bore	Ø mm	6H7	10H7	10H7
Stroke fine adjustment	mm	0.02	0.02	0.02
Stroke resolution	mm	0.005	0.005	0.005
Angle of rotation/mm stroke		3.3°	4.8°	non linear
Resolution, process data acquisition	stroke µm/inc force N/inc	5 0.125	5 1.25	5 3.5
Working height <sup>4)</sup>	F			
Frame No. 7-420	mm	60-420	50-410	50-290
Frame No. 7-600 <sup>2)</sup>	mm	90-600	80-600	80-480
Max. weight upper tool <sup>3)</sup>	kg	0.6	1	1.3
Weight	approx. kg	41	41	60
Protection type		IP 54	IP 54	IP 54

Accessories			
Stronger return assist spring		o	o
Speed control		o	o
Throat depth frame <sup>1)3)</sup> (total depth)		o	o
		169, 209, 249 mm	

## ManualPress 311

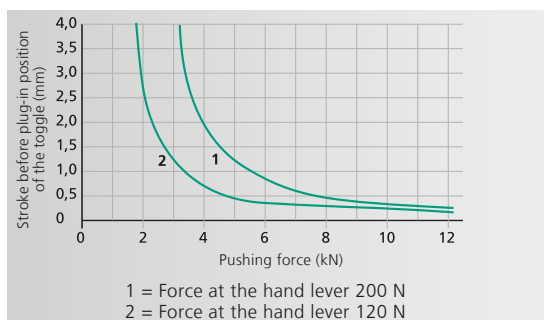

Maximum force will be reached just before extended position

Frame Overview	Press Type	Frame Height M (mm)	Table Size B x T (mm)	Table bore D Ø mm	Table Height K (mm)	Mounting Surface B x L (mm)
No. 7-420	305, 307, 311	740	180 x 150	20H7	90	220 x 362
No. 7-600 o	305, 307, 311	960	180 x 280	20H7	110	220 x 465

## Options

- o Additional charge applies
- <sup>1)</sup> Throat depth frame only available with frame No. 7-600
- <sup>2)</sup> Increased throat and higher frame lead to smaller nominal forces for No. 311
- <sup>3)</sup> The weight was determined with hand lever position 45° forward (guide)
- <sup>4)</sup> Typical values; can vary ± 3 mm due to casting and production tolerances

## Other available Options:

- Nickel plated – cast parts are electroless nickel plated, steel components black oxide finished, aluminum anodized, precision steel surfaces are untreated
- Custom paint – press and column can be painted to customer's color specification
- Bores for adapting tooling – customer specific sizes can be supplied

# SCHMIDT® ManualPress 300 Series

Options suitable for your application



## Control mounting bracket

Used for fastening the **SCHMIDT®** PressControl 700, either mounted to the table or to the wall. The mounting bracket permits the unit to pivot 70° (included with control).



## External reset button

We recommend an external reset button in rough production environments.



## Calibration tool

The calibration tool is a device with which a constantly defined force is applied to the load cell of the **SCHMIDT®** ManualPress Serie 300 Series. In order to complete calibration, either a **SCHMIDT®** LoadCheck or a customer supplied calibration device is required. Photo on left side shows the device for the **SCHMIDT®** ManualPress 305. The right side is for **SCHMIDT®** ManualPress 307. The **SCHMIDT®** ManualPress 311 is being calibrated by using the fine adjustment mechanism in BDC.



## EtherCAT Compact Box

8 digital channels, usable as inputs or outputs, signal connection by screwing via M8 plug connector, power supply (24 V) via EtherCAT-P, load currents of the outputs up to 0.5 A, total current of all outputs 3 A

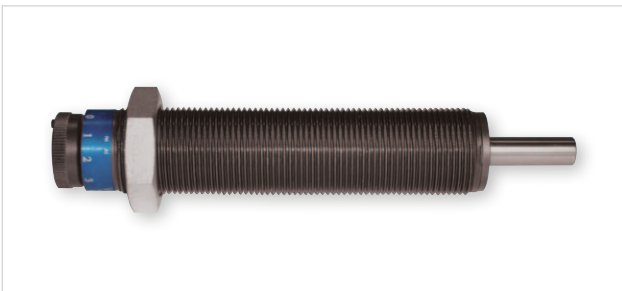

## Speed control

To achieve a very high repeatability when pressing to a force or stroke, the optional speed control can be added to provide hydraulic resistance to the ram movement over a targeted length at the end of the stroke.



## Ergonomic handle

Swivelling handle for improved comfort; easy and flexible assembly on the hand lever.



## Press base

Plastic (250 x 340 mm), incl. fasteners.

# SCHMIDT® PneumaticPress

## Maximum pressing force from 1.6 kN to 60 kN

The **SCHMIDT® PneumaticPress** range consists of a modular system suitable for transforming, joining and assembling operations optimally within the pressing capacities of 1.6 – 60 kN.

With the addition of the **SCHMIDT® PressControl 75** or **700** and the optional process monitoring, these presses become EC type-approved, CE-conformed workstations. Therefore these press systems can be used in either single cycle mode or automatic mode.

The application determines the selection of the press system. Consideration is given to the flexible design of the assembly location taking into account the ergonomic and safety aspects. These characteristics are achieved by means of a finely adjusted, modular type product range. The efficiency and increased process reliability of these press systems have been proven many thousands of times, in single applications, semi-automated assembly systems and have been integrated into automated production lines.



# SCHMIDT® PneumaticPress

Example of a system design with a direct acting press

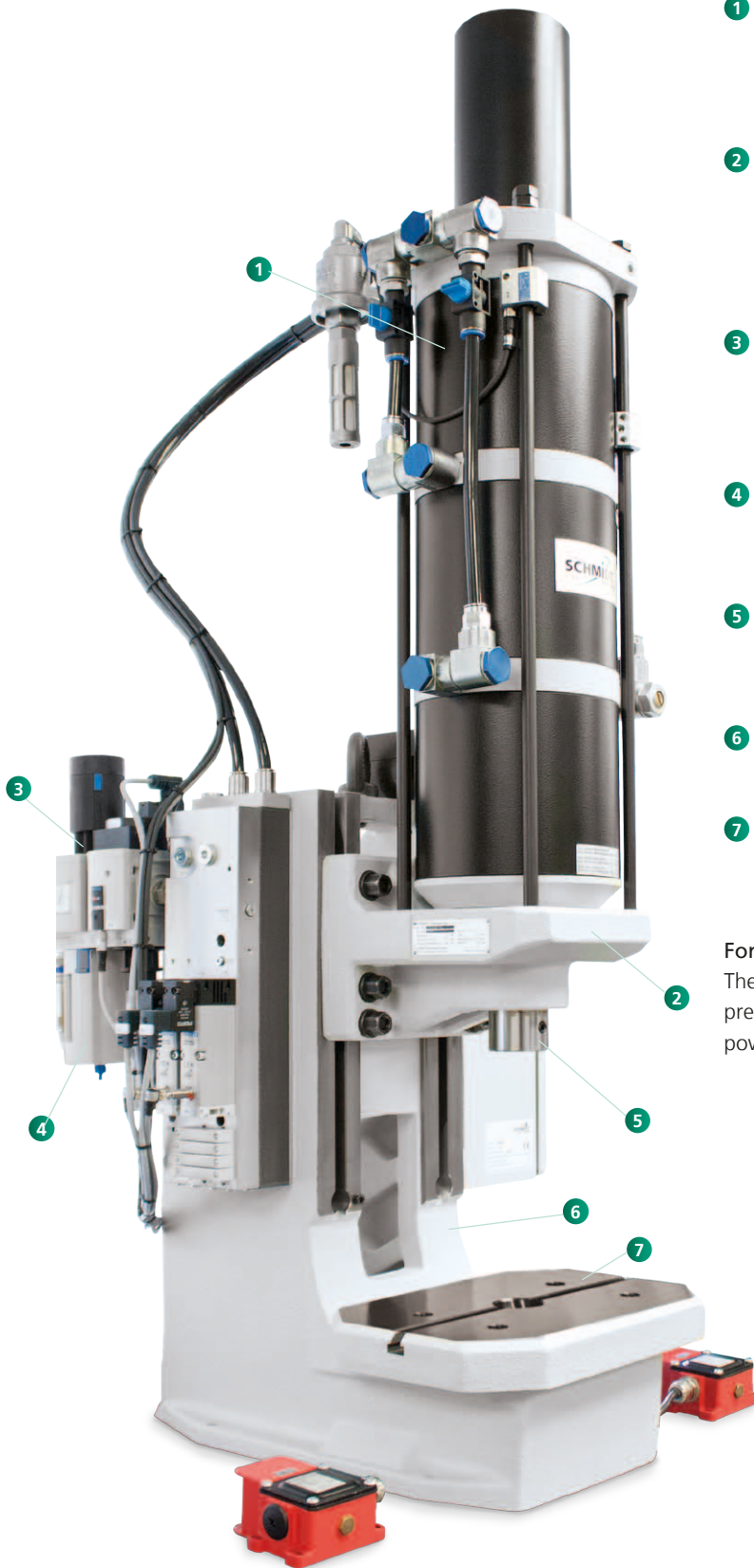

**1 Cylinder unit**

Maintenance-free specially developed for the assembly technology; with flow control for speed regulation of the down-stroke.

**2 Press Head unit**

The working height can be rapidly and accurately adjusted due to the height adjustment's ease of use. Can be used without the frame as processing station in automated installations.

**3 Pneumatic control package**

Two-channel pneumatic package (as shown) is based on a modular valve block, designed to operate with filtered, non-lubricated air, supply pressure range of 3 – 6 bar.

**4 Force control**

The press force output can easily be controlled via a separate pressure regulator and pressure gauge (not shown).

**5 Ram**

With precision bore for tool holding and built-in adjustable stop.

**6 Frame**

With precision machined press head guide rails.

**7 Fixture mounting plate**

With precision T-slot and bore for tool location.

**Force output preselector (optional)**

The press force output can easily be controlled via a separate pressure regulator and pressure gauge. The pressure for the power stroke can be reduced to 1 bar

# SCHMIDT® PneumaticPress

## Principle of operation

Functional description considering the example of a 3-chamber pneumatic cylinder

In working stroke, three pistons **7** connected by the piston rod **6** are pressurized with compressed air via the air connection **1** and move downward. The air below the pistons exhausts from the cylinder chambers via the depressurized connection **2** and the breather vents **3** and **4**. The ram **5** extends up to the maximum working stroke.

In return stroke, the upper cylinder chambers are depressurized via the connection **1** and only the bottom piston is pressurized with compressed air via the air connection **2**. Ambient air enters in both remaining cylinder chambers via the breather vents **3** and **4**. The ram with the three pistons moves upward.

This construction has the same effect as a parallel connection of three cylinders. Thus, a powerful working stroke is achieved with a compact design as well as an economic use due to the low air consumption in the return stroke.

The stroke can be limited by setting the Stroke Limit Block **8** to an approximate, desired position. The gap between Stroke Limit Block and Stroke Fine Adjustment **9** now determines the maximum stroke that the ram can travel. In order to fine-tune this stroke, the stop screw **9** can be adjusted.

All direct acting presses have a built-in permanent magnet **10**. This magnet facilitates sensing of the ram position via tie rod mounted sensors.

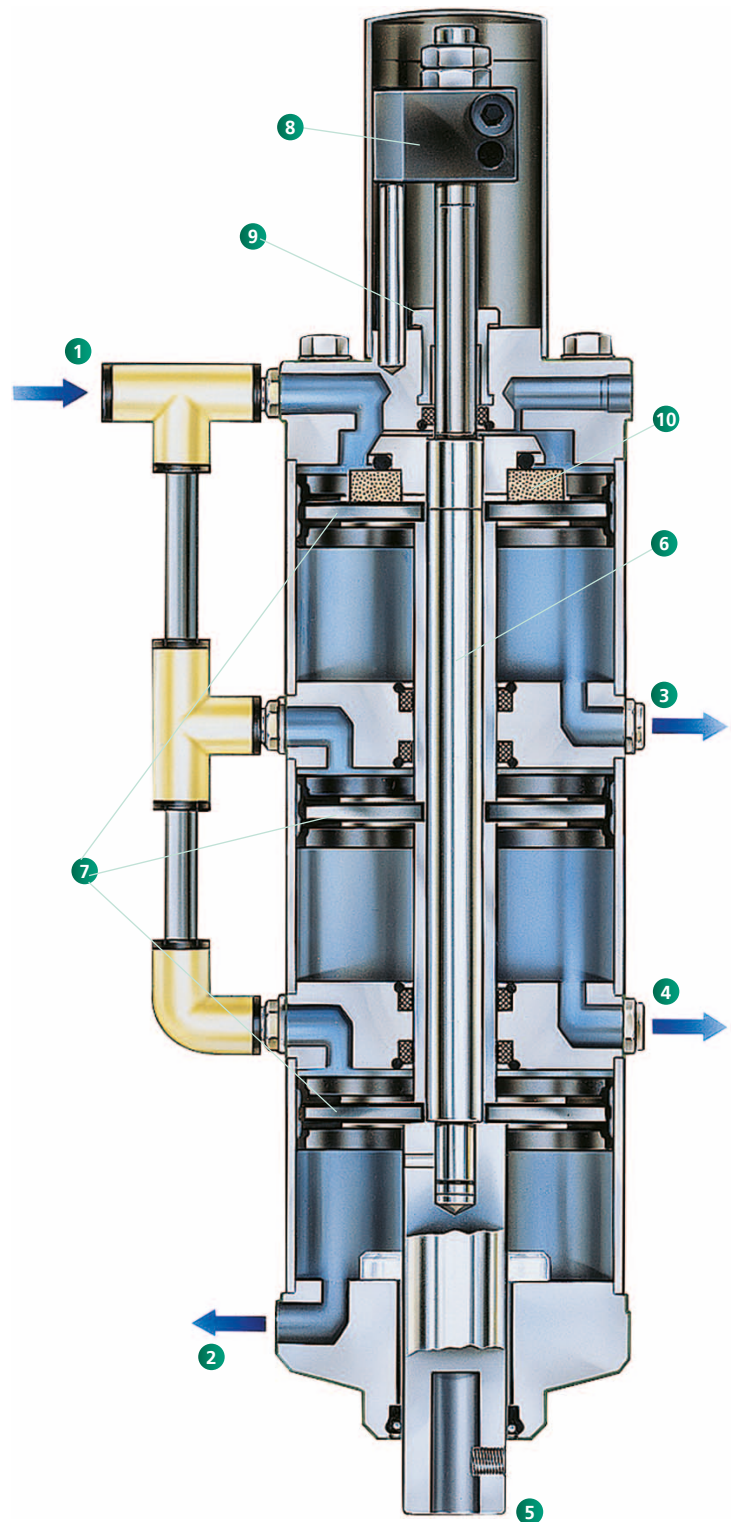

### Characteristics

- Optimally adapted to individual requirements due to its modular design
- Process optimization by means of adjustable parameters (stroke, force, speed)
- Easy adaptation to different tool and part heights because of simplistic stroke and height adjustment
- Additional safety measures when using heavy tools due to the optional device for retention of ram in home position
- End position control via cylinder switches as signal transmitter for peripheral processes
- Low noise level (< 75 dBA)
- Double-acting, wear-resistant cylinders with low air consumption for the return stroke
- High flexibility due to short changeover time
- Long service life and high precision due to wear-resistant Teflon coated bushings at top and bottom of cylinder
- Precision ground ram
- Precision double ram guides



# SCHMIDT® PneumaticPress

Direct acting with constant force over the entire stroke

## Characteristics

- Round anti-rotational ram
- Adjustable ram position in BDC by means of precision lower stop (1 division line = 0.05 mm) on scale
- T-slot with locking set screw in fixture mounting plate

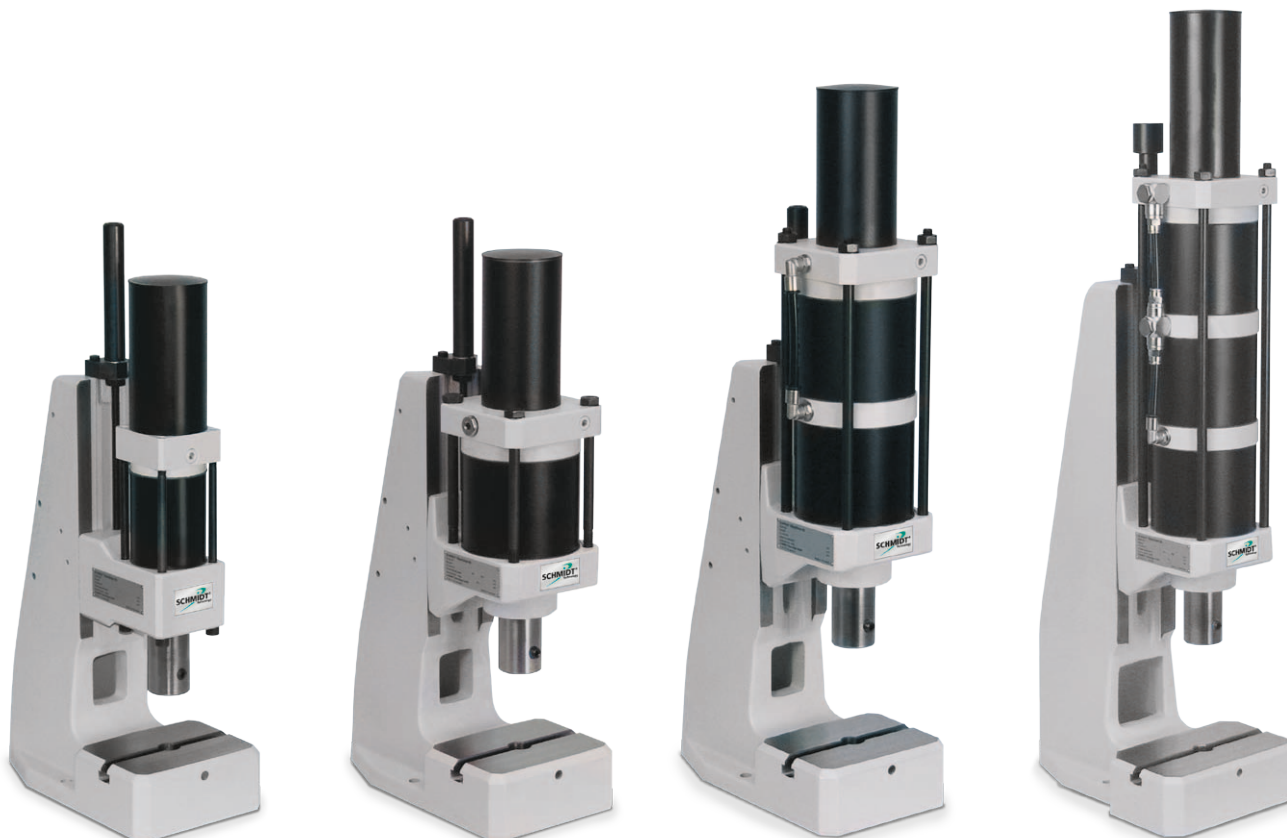

Press Type 20

Press Type 23

Press Type 24

Press Type 25



Pneumatic cylinder with piston and magnet kit for ram position via cylinder switch.

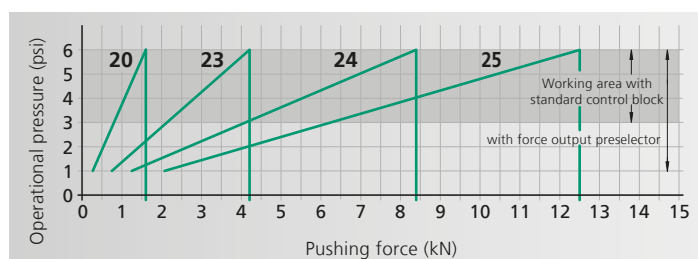

## From 1.6 kN to 12.5 kN

Press Type			20	23	24	25
Working stroke	<b>A</b>	mm	50, 75	50, 75	50, 75	50, 75
			100, 125	100, 125	100, 125	100
			160, 200	160, 200	160	
			250, 300	250, 300		
Nominal force at 6 bar		kN	1.6	4.2	8.4	12.5
Throat depth	<b>C</b>	mm	86	86	86	86
Throat depth frame $\circ$		mm	111, 131	111, 131	111, 131	111, 131
Additional fixture mounting plate suitable for throat depth frame			$\circ$	$\circ$	$\circ$	$\circ$
Ram bore	$\emptyset$	mm	20H7	20H7	20H7	20H7
Ram diameter	$\emptyset$	mm	40	40	40	40
Working height <sup>1)</sup>	<b>F</b>					
Frame No. 3		mm	80-220	90-210	90-210	90-210
Frame No. 2 $\circ$		mm	110-360	120-350	120-350	120-350
Frame No. 2-600 $\circ$		mm	200-600	210-580	210-580	210-580
Frame No. 2-1000 $\circ$		mm	330-1040	335-1020	335-1020	335-1020
Weight		approx. kg	30	35	40	45
<b>Flange model</b>			20-FL	23-FL	24-FL	25-FL
Cylinder	<b>Z</b>	$\emptyset$ mm	69	106	106	106
Flange	<b>FL</b>	$\emptyset$ mm	110	140	140	140
Width across flats	<b>SW</b>	mm	80	112	112	112
Centering shoulder	<b>ZA</b>	$\emptyset$ mm	60	68	68	68

Frame Overview	Press Type	Frame Height M (mm)	Table Size B x T (mm)	Table Bore D $\emptyset$ mm	Table Height K (mm)	Mounting Surface B x L (mm)
No. 3	20, 23, 24, 25	540	150 x 110	20H7	60	150 x 260
No. 2	20, 23, 24, 25	700	185 x 110	20H7	60	185 x 280
No. 2-600 $\circ$	20, 23, 24, 25	974	200 x 160	20H7	98	200 x 290
No. 2-1000 $\circ$	20, 23, 24, 25	1410	200 x 160	20H7	98	200 x 290

### Options

$\circ$  Additional charge applies

<sup>1)</sup> Typical values; can vary  $\pm 3$  mm due to casting and production tolerances

### Other available options

- Nickel plated – cast parts are electroless nickel plated, steel components black oxide finished, aluminum anodized, precision steel surfaces are untreated
- Custom Paint – press and column can be painted to customer's color specification
- Bores for adapting tooling – customer specific sizes can be supplied

### Bottom View of the Press Head, Flange Model

Mounting drill pattern flange/ram

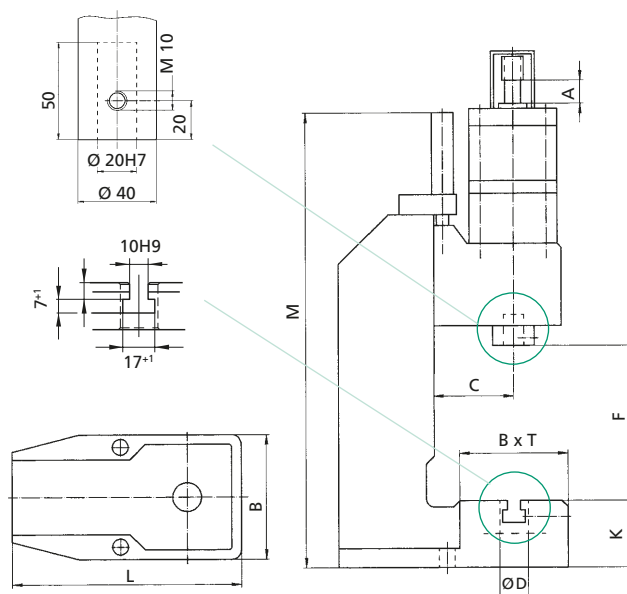
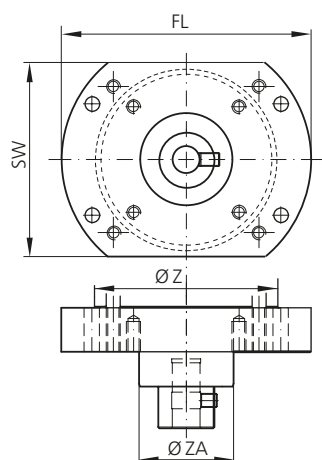

Detailed dimensional drawings can be downloaded: [www.schmidttechnology.de](http://www.schmidttechnology.de)

# SCHMIDT® PneumaticPress

Direct acting with constant force over the entire stroke

## Characteristics

- Round anti-rotational ram
- Adjustable ram position in BDC by means of precision lower stop (1 division line = 0.05 mm) on scale



Press Type 27



Press Type 29



Precision lower stop

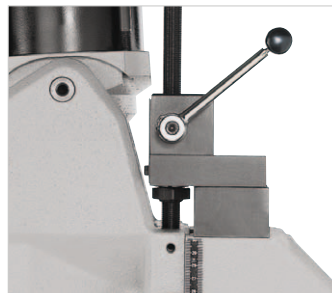

Height adjustment  
Fast, accurate setting of the work height.

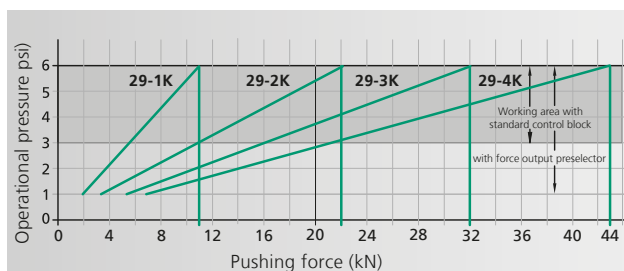
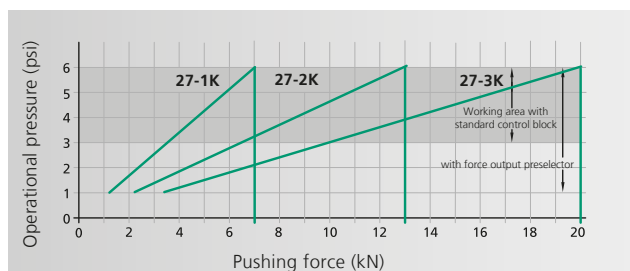

## From 7 kN to 43 kN

Press Type			27-1K	27-2K	27-3K	29-1K	29-2K	29-3K	29-4K
Working stroke	A	mm	50, 75, 100	50, 75	50, 75	50, 75	50, 75	50, 75	50, 75
			160, 200	100, 125	100, 125	100, 160	100, 125	100, 125	100, 125
			250, 300	160, 200	160	200, 300	160, 200	160	100
Nominal force at 6 bar		kN	7	13	20	11	22	32	43
Throat depth	C	mm	131	131	131	140	140	140	140
Throat depth frame $\circ$		mm	151	151	151	160, 185	160, 185	160, 185	160
Additional fixture mounting plate suitable for throat depth frame			$\circ$	$\circ$	$\circ$	$\circ$	$\circ$	$\circ$	$\circ$
Ram bore	$\emptyset$	mm	20H7	20H7	20H7	20H7	20H7	20H7	20H7
Ram diameter	$\emptyset$	mm	40	40	40	50	50	50	50
Working height <sup>1)</sup>									
Frame No. 34		mm	90-270	90-270	90-270				
Frame No. 301 $\circ$		mm	160-400	160-400	160-400				
Frame No. 301-500 $\circ$		mm	310-550	310-550	310-550				
Frame No. 29		mm				80-290	80-290	80-290	80-290
Frame No. 29-500 $\circ$		mm				150-500	150-500	150-500	150-500
Frame No. 29-600 $\circ$		mm				250-600	250-600	250-600	250-600
Weight (standard)		approx. kg	85	85	85	120	120	120	120
<b>Flange model</b>			27-1K-FL	27-2K-FL	27-3K-FL	29-1K-FL	29-2K-FL	29-3K-FL	29-4K-FL
Cylinder	Z	$\emptyset$ mm	132	132	132	170	170	170	170
Flange	FL	$\emptyset$ mm	180	180	180	220	220	220	220
Width across flats	SW	mm	140	140	140	180	180	180	180
Centering shoulder	ZA	$\emptyset$ mm	68	68	68	80	80	80	80

Frame Overview	Press Type	Frame Height M (mm)	Table Size B x T (mm)	Table Bore D $\emptyset$ mm	Table Height K (mm)	Mounting Surface B x L (mm)
No. 34	27	630	200 x 160	25H7	111	200 x 370
No. 301	27	830	250 x 200	40H7	145	250 x 460
Frame No. 301-500 $\circ$	27	990	250 x 200	40H7	145	250 x 480
Special fixture mounting plate with 3 longitudinal slots $\circ$			300 x 220 400 x 230	40H7 40H7		
Frame No. 29	29	690	300 x 220	40H7	141	300 x 460
Frame No. 29-500 $\circ$	29	990	300 x 220	40H7	166	300 x 540
Frame No. 29-600 $\circ$	29	1110	300 x 220	40H7	166	300 x 565
Special fixture mounting plate with 3 longitudinal slots $\circ$			355 x 225 400 x 230	40H7 40H7		

<sup>1)</sup> Typical values; can vary  $\pm 3$  mm due to casting and production tolerances

### Options

$\circ$  Additional charge applies

### Other available options

- Nickel plated – cast parts are electroless nickel plated, steel components black oxide finished, aluminum anodized, precision steel surfaces are untreated
- Custom Paint – press and column can be painted to customer's color specification
- Bores for adapting tooling – customer specific sizes can be supplied

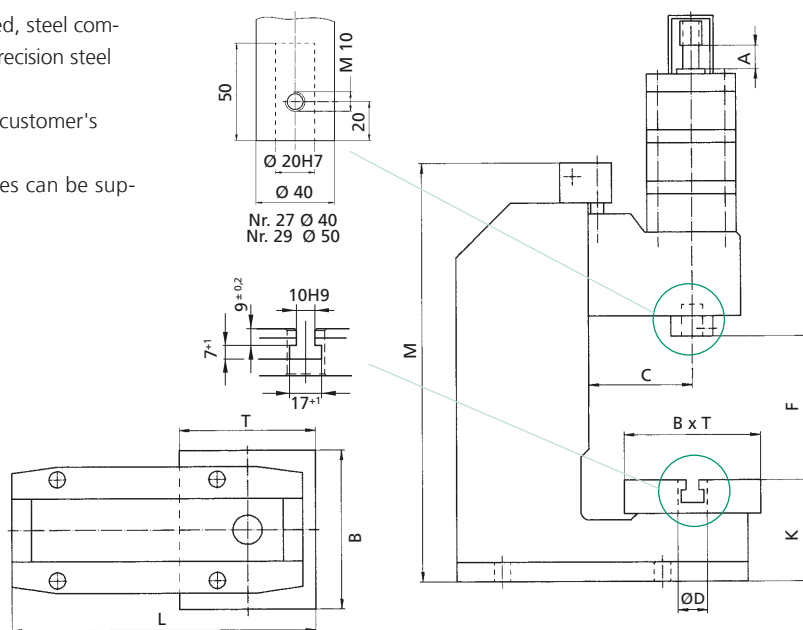
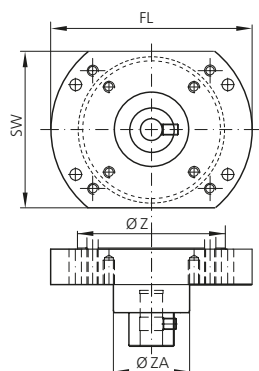

Detailed dimensional drawings can be downloaded: [www.schmidttechnology.de](http://www.schmidttechnology.de)

# SCHMIDT® PneumaticPress

Pneumatic Toggle Presses with maximum force at the end of stroke

## Characteristics

- Cross hole with locking screw in the press table for safe fixture of tool
- Accurate adjustable ram position via fine adjustment (type 33)
- T-slot with set screw in fixture mounting plate to secure bottom tool



Press Type 32



Press Type 33



Fine adjustment for press No. 33 with scale 1 division line = 0.02 mm.



Flexible stroke adjustment reduces the air consumption for shorter strokes.

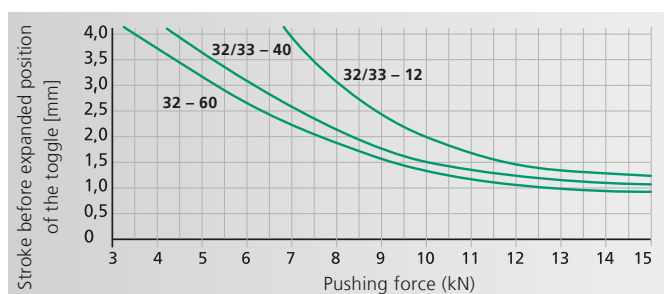

## Up to 15 kN

Press Type			32	33
Working stroke	<b>A</b>	mm	0-12 4-40 6-60	0-12 4-40
Nominal force at 6 bar		kN	15	15
Throat depth	<b>C</b>	mm	86	86
Throat depth frame $\circ$		mm	111, 131	111, 131
Additional fixture mounting plate suitable for throat depth frame			$\circ$	$\circ$
Ram bore	$\emptyset$	mm	20H7	20H7
External ram dimensions	$\emptyset$	mm	40	40
Fine adjustment				•
Working height <sup>1)</sup>	<b>F</b>			
Frame No. 3		mm	80 – 205	
Frame No. 5		mm	80 – 350	35 – 295
Frame No. 2-600 $\circ$		mm	200 – 575	155 – 520
Frame No. 2-1000 $\circ$		mm	330 – 1020	285 – 965
Weight		approx. kg	45	50

Frame Overview	Press Type	Frame Height M (mm)	Table Size B x T (mm)	Table Bore D $\emptyset$ (mm)	Table Height K (mm)	Mounting Surface B x L (mm)
No. 3	32	540	150 x 110	20H7	60	150 x 260
No. 5	32, 33	536	185 x 110	20H7	60	185 x 280
Frame No. 2-600 $\circ$	32, 33	810	200 x 160	20H7	98	200 x 290
Frame No. 2-1000 $\circ$	32, 33	1248	200 x 160	20H7	98	200 x 290

### Options

- Series standard with no additional charge
- Additional charge applies
- <sup>1)</sup> Typical values; can vary  $\pm 3$  mm due to casting and production tolerances

### Other available options

- Nickel plated – cast parts are electroless nickel plated, steel components black oxide finished, aluminum anodized, precision steel surfaces are untreated
- Custom Paint – press and column can be painted to customer's color specification
- Bores for adapting tooling – customer specific sizes can be supplied

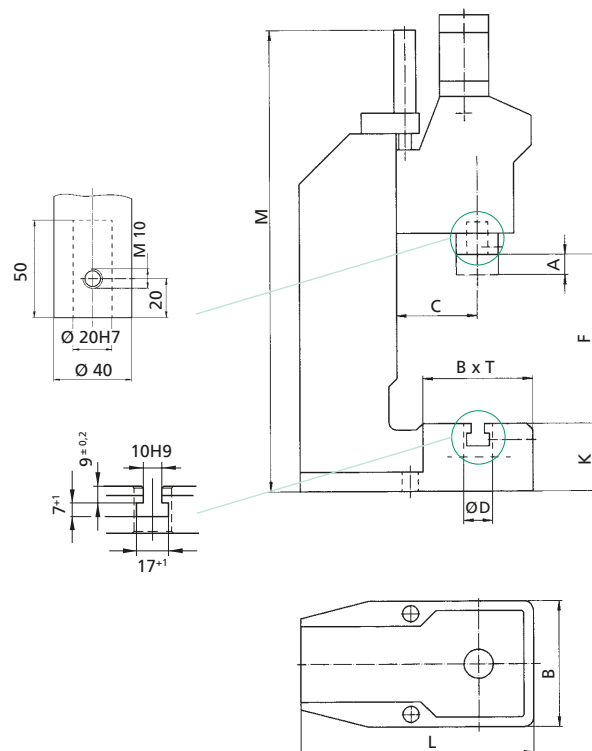

Detailed dimensional drawings can be downloaded: [www.schmidttechnology.de](http://www.schmidttechnology.de)

# SCHMIDT® PneumaticPress

Pneumatic Toggle Presses with maximum force at the end of stroke

## Characteristics

- Anti-rotational square ram with fully adjustable, Teflon lined gibs for precise travel, no die set required
- Exact positioning due to fine adjustment scale (1 division line = 0.05 mm)

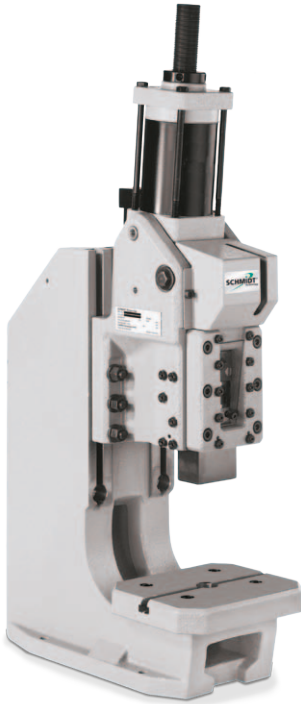

Press Type 34



Press Type 36

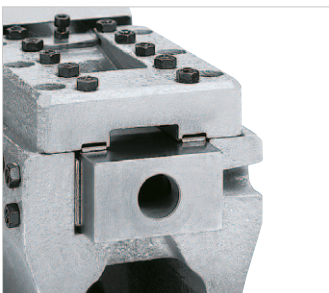

Square ram



Fine adjustment

## Pushing Force Diagram

Operational pressure: 6 bar

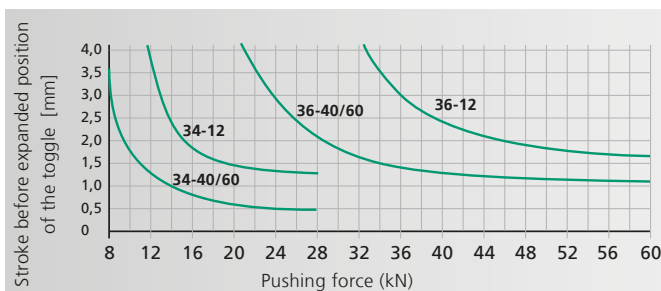

## From 28 kN to 60 kN

Press Type			34	36
Working stroke	<b>A</b>	mm	0-12 4-40 6-60	0-12 4-40 6-60
Nominal force at 6 bar		kN	28	60
Throat depth	<b>C</b>	mm	131	160
Throat depth frame $\phi$		mm	151, 170	185
Fixture mounting plate suitable for throat depth frame			$\phi$	$\phi$
Ram bore	$\phi$	mm	20H7	20H7
External ram dimensions	<b>G x H</b>	mm	36 x 63	46 x 86
Working height <sup>1)</sup>	<b>F</b>			
Frame No. 34		mm	100-250	
Frame No. 301		mm	160-400	
Frame No. 301-500		mm	310-550	
Frame No. 35		mm		100 - 250
Frame No. 35-500		mm		150-500
Frame No. 35-600		mm		250-600
Weight		approx. kg	90	150

Frame Overview	Press Type	Frame Height M (mm)	Table Size B x T (mm)	Table Bore D $\phi$ mm	Table Height K (mm)	Mounting Surface B x L (mm)
No. 34	34	630	200x160	25H7	111	200 x 370
No. 301	34	830	250x200	40H7	145	250 x 460
No. 301-500	34	990	250x200	40H7	145	250 x 480
Special fixture mounting plate with 3 longitudinal slots $\phi$			300 x 220 400 x 230	40H7		
No. 35	36	700	300 x 220	40H7	141	300 x 480
No. 35-500	36	990	300 x 220	40H7	166	300 x 560
No. 35-600	36	1110	300 x 220	40H7	166	300 x 585
Special fixture mounting plate with 3 longitudinal slots $\phi$			355 x 225 400 x 280	40H7		

### Options

$\phi$  Additional charge applies

<sup>1)</sup> Typical values; can vary  $\pm 3$  mm due to casting and production tolerances

### Other available options

- Nickel plated – cast parts are electroless nickel plated, steel components black oxide finished, aluminium anodized, precision steel surfaces are untreated
- Custom Paint – press and column can be painted to customer's color specification
- Bores for adapting tooling – customer specific sizes can be supplied

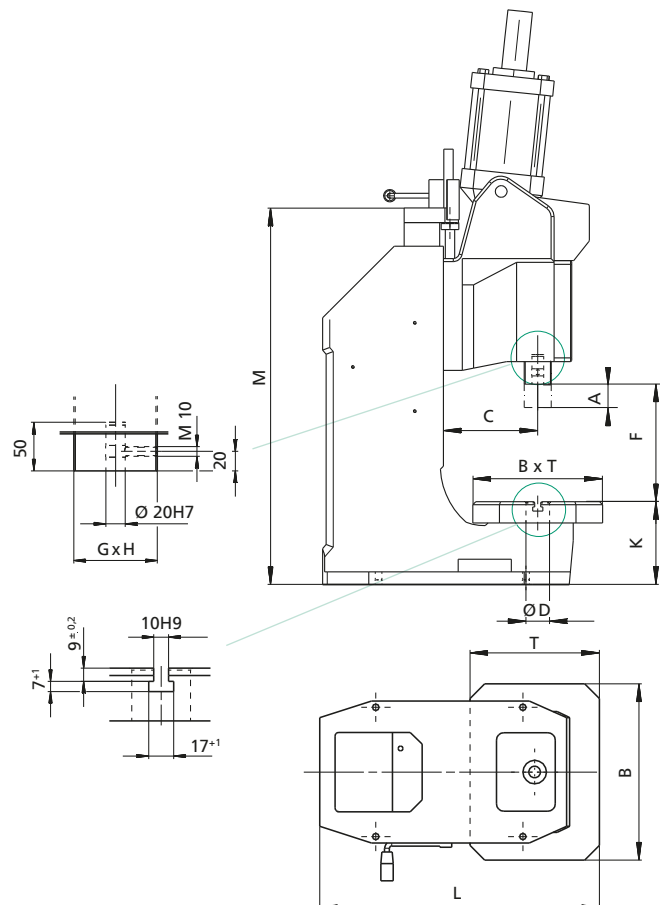

Detailed dimensional drawings can be downloaded: [www.schmidttechnology.de](http://www.schmidttechnology.de)



# SCHMIDT® PneumaticPress

## Direct acting Pneumatic Presses with force/stroke monitoring

SCHMIDT® PneumaticPresses with force/stroke monitoring are offered as complete system with control unit SCHMIDT® Press-Control 700. These systems are characterized by sensors and signal amplification integrated in the press head. These signals are evaluated in real time.

### Characteristics

- Direct forces are measured due to the force sensor integrated in the ram. Insensitive against side loads
- Force and displacement sensors are immune to EMI and environmental conterminaton
- A measuring data amplification integrated in the press head provides short transmission paths of unamplified signals
- Anti-rotational square ram with two fully adjustable guiding gibs for precise work, also with tools without guide (not for type 320, here special anti-twist protection in the roller-guided round ram)



Press Type 323, 327, 329



Press Type 320

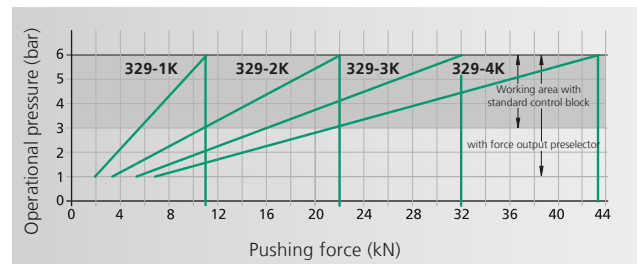
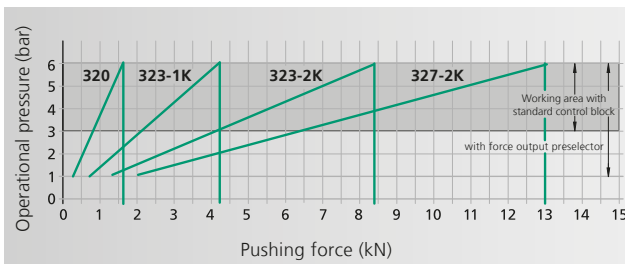

## From 1.6 kN to 43 kN

Press Type			320	323-1K	323-2K	327-2K	327-3K	329-2K	329-3K	329-4K
Working stroke	<b>A</b>	mm	100	50, 75, 100, 125, 150	50, 75, 100	50, 75, 100, 125, 150	50, 75, 100	50, 75, 100, 150	50, 75, 100, 125, 150	50, 75, 100
Nominal force at 6 bar		kN	1.6	4.2	8.4	13	20	22	32	43
Resolution, process data acquisition										
- stroke		µm/inc	5	5	5	5	5	5	5	5
- force		N/inc	0.5	1.25	2.5	4	6.25	6.25	10	12.5
Throat depth	<b>C</b>	mm	129	131	131	131	131	160	160	160
Throat depth frame $\phi$		mm		151	151	151	151			
Fixture mounting plate suitable for throat depth frame				o	o	o	o			
Ram bore	$\phi$	mm	20H7	20H7	20H7	20H7	20H7	20H7	20H7	20H7
External ram dimensions	<b>G x H</b>	mm	$\phi$ 40	70 x 50	70 x 50	70 x 50	70 x 50	90 x 60	90 x 60	90 x 60
Working height <sup>1)</sup>	<b>F</b>									
Frame No. 7-420		mm	50-420							
Frame No. 7-600 $\phi$		mm	85-600							
Frame No. 301		mm		140-350	140-350	140-350	140-350			
Frame No. 301-500 $\phi$		mm		310-500	310-500	310-500	310-500			
Frame No. 329		mm						130-300	130-300	130-300
Frame No. 329-460 $\phi$		mm						190-460	190-460	190-460
Weight (standard)		approx. kg	70	170	170	170	170	320	325	330

Frame Overview	Press Type	Frame Height M (mm)	Table Size B x T (mm)	Table Bore D $\phi$ mm	Table Height K (mm)	Mounting Surface B x L (mm)
No. 7-420	320	740	180 x 150	20H7	90	220 x 362
No. 7-600	320	960	180 x 280	20H7	110	220 x 465
No. 301	323, 327	830	250 x 200	40H7	145	250 x 460
No. 301-500	323, 327	990	250 x 200	40H7	145	250 x 480
Special fixture mounting plate with 3 longitudinal slots <sup>2)</sup> $\phi$			300 x 220 400 x 230	40H7		
No. 329	329	810	300 x 230	40H7	147	300 x 550
No. 329-460	329	990	300 x 230	40H7	147	300 x 620
Special fixture mounting plate with 3 longitudinal slots <sup>2)</sup> $\phi$			400 x 280 500 x 280	40H7		

### Options

$\phi$  Additional charge applies

<sup>1)</sup> Typical values; can vary  $\pm 3$  mm due to casting and production tolerances

<sup>2)</sup> With Press type **320** only in combination with frame type No. **7-600** with 168 mm, 208 mm or 248 mm

### Other available options

- Nickel plated – cast parts are electroless nickel plated, steel components black oxide finished, aluminium anodized, precision steel surfaces are untreated
- Custom Paint – press and column can be painted to customer's color specification
- Bores for adapting tooling – customer specific sizes can be supplied

### Bottom view of the press head

Fastening drill pattern flange/ram

#### Press Type 323/327

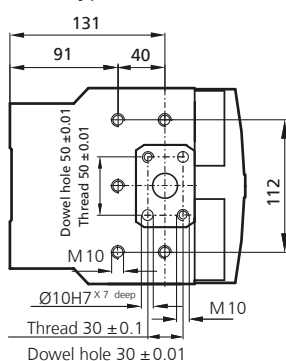

#### Press Type 329

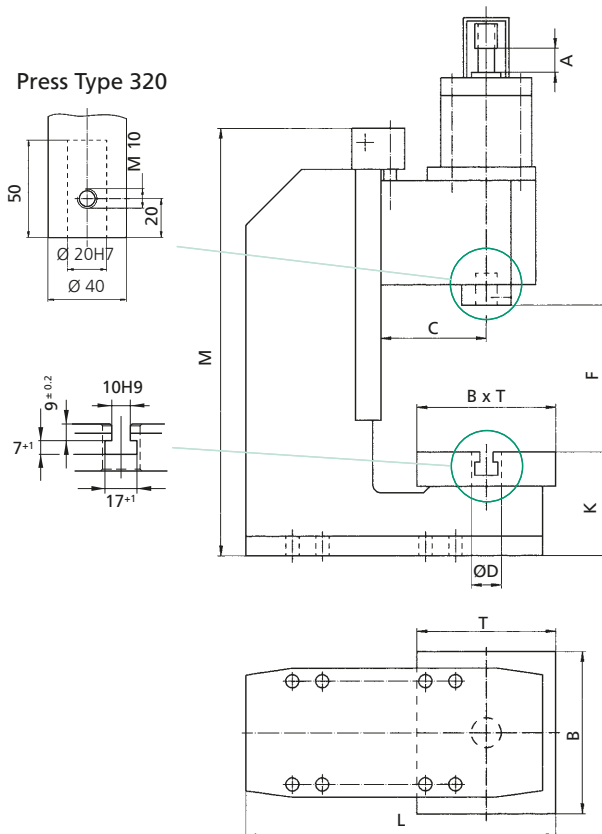
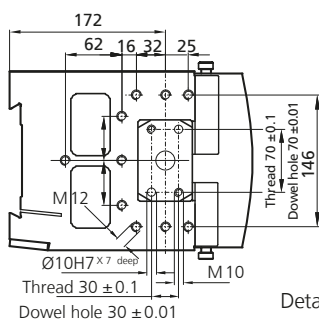

Detailed dimensional drawings can be downloaded: [www.schmidttechnology.de](http://www.schmidttechnology.de)



**SCHMIDT®** PneumaticPress 323 with PressControl 700 and two-hand release on height-adjustable PU40 and transparent protective housing as EC type-examination approved single workstation.

# SCHMIDT® HydroPneumaticPress

## Maximum force range from 15 kN to 220 kN

The **SCHMIDT® HydroPneumaticPress** range consists of a modular system suitable for transforming, joining and assembling optimally within the pressing force range 15 – 220 kN.

With the addition of the **SCHMIDT® PressControl 75** or **700** and the optional process monitoring, these presses become EC type-approved, CE-conformed workstations. Therefore these press systems can be used in either single cycle mode or automatic mode.

The application determines selection of the press system. Consideration is given to the flexible design of the assembly location taking into account the ergonomic and safety aspects. These characteristics are achieved by means of a finely adjusted, modular type product range. The efficiency and increased process reliability of these press systems have been proven many thousands of times, in single applications, semi-automated assembly systems and have been integrated into automated production lines.



# SCHMIDT® HydroPneumaticPress

## System design



- 1 Cylinder unit**  
Hydro pneumatic
- 2 Air throttle rapid approach stroke**  
For speed control of the downstroke
- 3 Press head unit**  
The working height can be rapidly and accurately adjusted due to the height adjustment's ease of use. Can be used without the frame as processing station in automated installations
- 4 Pneumatic control package**  
Two-channel pneumatic package (as shown) is based on a modular valve block
- 5 Force output preselector**  
The press force output can easily be controlled via a separate pressure regulator and pressure gauge. The pressure for the power stroke can be reduced to 1 bar
- 6 Square ram**  
Square ram with fully adjustable, Teflon lined gibs for precise travel, precision machined bore
- 7 Frame**  
With precision machined press head guide rails (for No. 68 and 368 designed as dovetail guide)
- 8 Fixture mounting plate**  
With precision T-slot and bore for tool location



### Stroke feedback

Ram with key-ways for switch target pieces for an inductive position feedback. Optional: Stroke-dependent activation of the power stroke by means of the proximity switch.

# SCHMIDT® HydroPneumaticPress

## Principle of operation

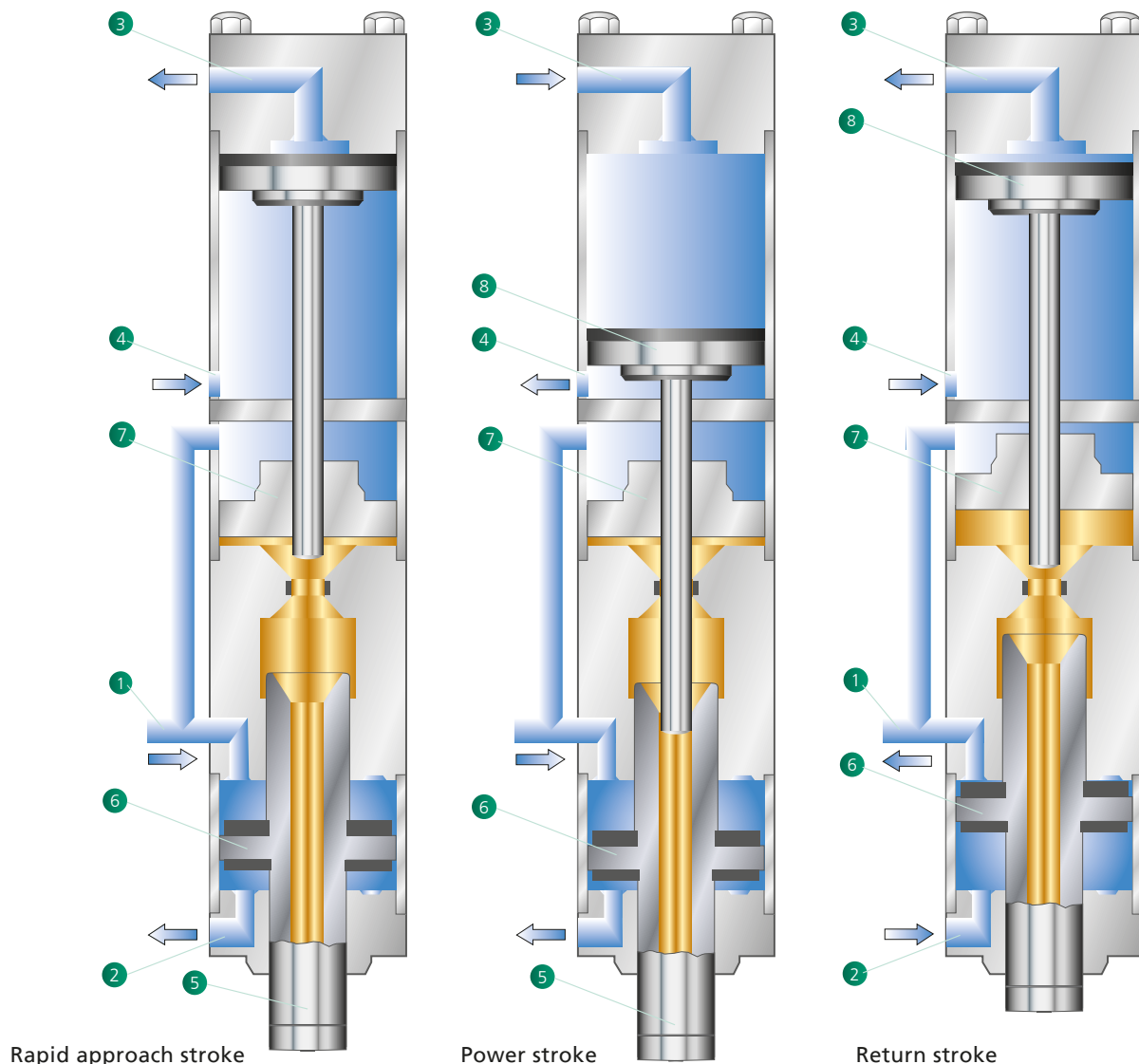

### Rapid approach stroke

In rapid approach stroke, the air connections 1 and 4 are pressurized with compressed air. The air connections 2 and 3 are depressurized. The approach stroke piston 6 and the reservoir piston 7 are moving with low force until the ram 5 encounters resistance.

### Power Stroke

If the ram 5 encounters resistance, a valve switches the compressed air from 4 to connection 3, and the power stroke piston 8 moves downwards. A rod enters the high pressure cylinder, separating the hydraulic oil between reservoir piston 7 and approach stroke piston 6. The ram 5 moves out with boosted force.

### Return Stroke

For the return stroke, the connections 1 and 3 are depressurized, and the connections 2 and 4 are pressurized. Approach stroke 6 and power stroke piston 8 move back simultaneously. After the hydraulic connection between approach 6 and reservoir piston 7 oil flows back into the reservoir, moving the reservoir piston into its home position.

### Characteristics

- Optimally adapted to individual requirements due to its modular design
- High flexibility and economic efficiency due to short changeover times
- Easy and accurate positioning of tools due to the precise alignment between ram bore and the ground fixture mounting plate.
- The force output preselector allows reducing the pressure for the power stroke to 1 bar. This reduces the nominal press force to 1/6 of the maximum force.
- The end positions of the ram can be sensed via the inductive proximity switches.
- No mechanical compression spring in the cylinder of the hydro-pneumatic system, providing a long service life
- Low maintenance resulting in high productivity
- Long service life and precision due to maintenance-free guides
- Tool protection due to smooth switchover from rapid approach stroke to power stroke
- Additional safety when using heavy tools due to the optional ram drift lock device for retention of ram in home position.
- Low noise level (< 75 dBA)

# SCHMIDT® HydroPneumaticPress

## C-Frame design

### Characteristics

- The C-Frame design offers full accessibility when manually inserting and removing parts
- Easy adaptation to different tool and part heights because of simplistic height adjustment with angular gear
- Anti-rotational square ram with fully adjustable, Teflon lined gibs for precise travel. No die set required
- High precision due to long precise guides of the square ram



Press type 61/62



Press type 65

Adjustable switch target pieces for position detection via an inductive position sensor

### Rapid approach stroke

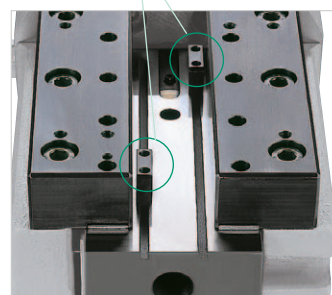
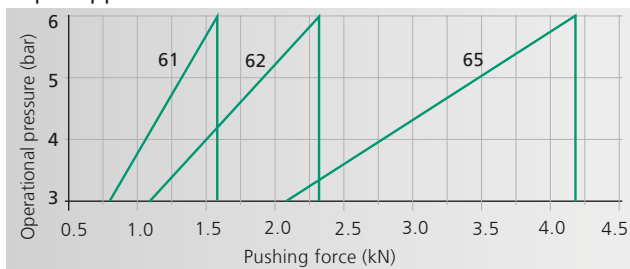

**Square ram** with bilaterally adjustable, play-free gibs, precision machined bore with set screw for mounting of tooling.

### Power stroke

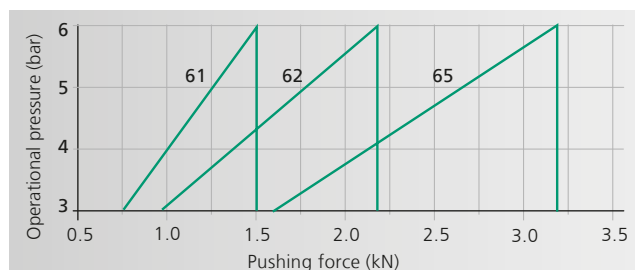
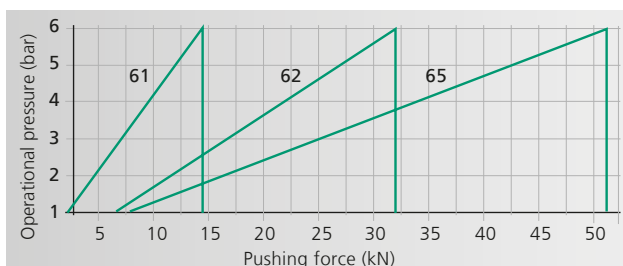

Operational pressure < 3 bar: can only be operated with press force preselector!

## From 15 kN to 52 kN in power stroke

Press Type			61	62	65
Total stroke - Power stroke <sup>1)</sup>		mm	50 – 6, 100 – 12	50 – 6, 100 – 12	50 – 6, 100 – 12
Nominal force at 6 bar		kN	15	30	52
Throat depth	<b>C</b>	mm	131	131	160
Throat depth frame $\circ$		mm	151	151	185
Fixture mounting plate suitable for throat depth frame			$\circ$	$\circ$	$\circ$
Ram bore	$\emptyset$	mm	20H7	20H7	20H7
External ram dimensions	<b>G x H</b>	mm	36 x 63	36 x 63	46 x 86
Working height <sup>2)</sup>	<b>F</b>				
Frame No. 34		mm	100 – 250	100 – 250	
Frame No. 301 $\circ$		mm	160 – 400	160 – 400	
Frame No. 301-500 $\circ$		mm	310 – 550	310 – 550	
Frame No. 35		mm			80 – 270
Frame No. 35-500 $\circ$		mm			150 – 500
Frame No. 35-600 $\circ$		mm			250 – 600
Weight (standard)	approx. kg		95	110	160

Frame Overview	Press Type	Frame Height M (mm)	Table Size B x T (mm)	Table Bore D $\emptyset$ mm	Table Height K (mm)	Mounting Surface B x L (mm)
No. 34	61, 62	630	200 x 160	25H7	111	200 x 370
No. 301	61, 62	830	250 x 200	40H7	145	250 x 460
No. 301-500	61, 62	990	250 x 200	40H7	145	250 x 480
Special fixture mounting plate with 3 longitudinal slots $\circ$			300 x 220 400 x 230	40H7		
No. 35	65	700	300 x 220	40H7	141	300 x 480
No. 35-500	65	990	300 x 220	40H7	166	300 x 560
No. 35-600	65	1110	300 x 220	40H7	166	300 x 585
Special fixture mounting plate with 3 longitudinal slots $\circ$			355 x 225 400 x 280	40H7		

### Options

$\circ$  Additional charge applies

<sup>1)</sup> Stroke variants on request

<sup>2)</sup> Typical values; can vary  $\pm 3$  mm due to casting and production tolerances

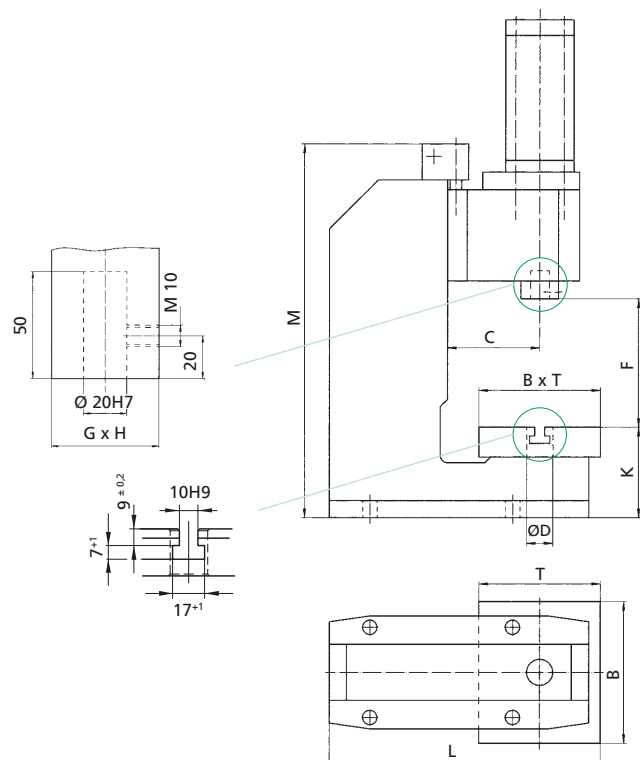

Detailed dimensional drawings can be downloaded: [www.schmidttechnology.de](http://www.schmidttechnology.de)



# SCHMIDT® HydroPneumaticPress

## C-Frame design with welded press frame

### Characteristics

- The welded press frame offers highest stability
- Space-saving and compact due to separate working cylinder for press No. 68



Press type 68



Press type 64



### Square ram

with bilaterally adjustable, play-free gibs, precision machined bore with set screw for mounting of tooling. Some models feature additional provisions for tooling adaption.

### Rapid approach stroke

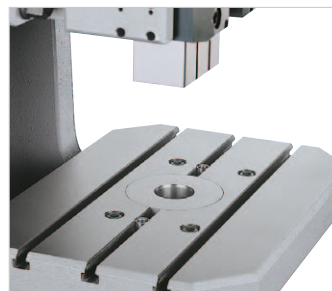
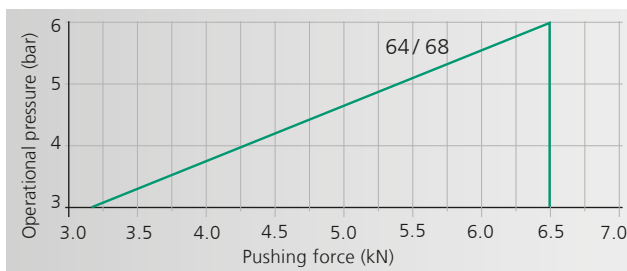

### Fixture mounting plate

(for Press No. 64) with 3 T-slots and precision machined bore for tool location.

### Power stroke

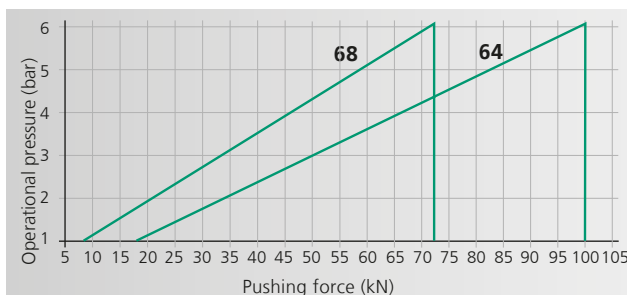

### Return stroke

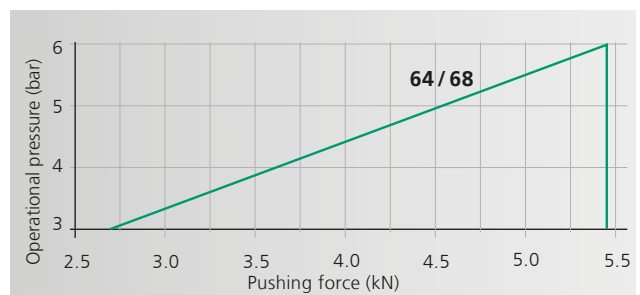

Operational pressure < 3 bar: can only be operated with press force preselector!

## From 72 kN to 100 kN in power stroke

Press Type			64	68
Total stroke - Power stroke <sup>1)</sup>		mm	50-6, 100-12	50-6, 100-12
Nominal force at 6 bar		kN	100	72
Throat depth	<b>C</b>	mm	160	160
Ram bore	<b>E</b>	Ø mm	25H7	20H7
External ram dimensions	<b>G x H</b>	mm	60 x 90	60 x 90
Working height <sup>2)</sup>	<b>F</b>			
Frame No. 64		mm	180-350	
Frame No. 64-600 o		mm	430-600	
Frame No. 68 <sup>2)</sup>		mm		130-300
Frame No. 68/5 <sup>2)</sup> o		mm		190-460
Weight (standard)		approx. kg	420	350

Frame Overview	Press Type	Frame Height M (mm)	Table Size B x T (mm)	Table Bore D Ø mm	Table Height K (mm)	Mounting Surface B x L (mm)
No. 64	64	940	400 x 290	40H7	185	400 x 625
No. 64-600 o	64	1200	400 x 290	40H7	185	400 x 685
No. 68 <sup>2)</sup>	68	810	300 x 230	40H7	147	300 x 550
No. 68/5 <sup>2)</sup> o	68	990	300 x 230	40H7	147	300 x 620
Special fixture mounting plate with 3 longitudinal slots o			400 x 280 500 x 280	40H7		

### Options

- o Additional charge applies
- <sup>1)</sup> Stroke variants on request
- <sup>2)</sup> Frame 68/5 required for 30 mm power stroke
- <sup>3)</sup> Typical values; can vary ± 3 mm due to casting and production tolerances

Bottom view of the press head  
Mounting drill pattern flange/ram

Press type 64

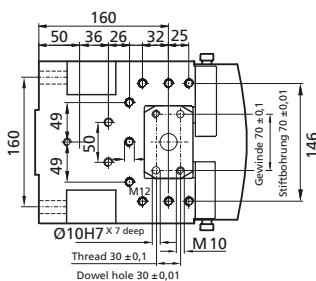

Press type 68

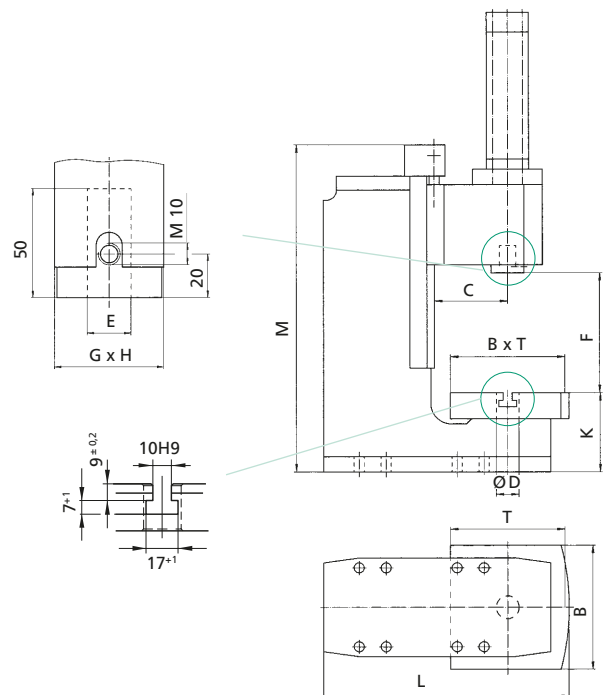
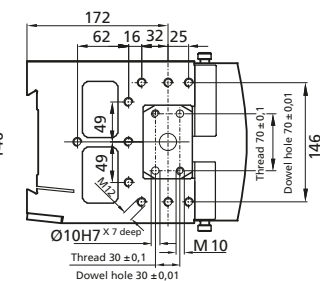

Detailed dimensional drawings can be downloaded: [www.schmidttechnology.de](http://www.schmidttechnology.de)

# SCHMIDT® HydroPneumaticPress

## C-Frame design with force/stroke monitoring

SCHMIDT® HydroPneumaticPresses with force / stroke monitoring are offered as complete system with control unit SCHMIDT® PressControl 700. These systems are characterized by sensors and signal amplification integrated in the press head. These signals are evaluated in real time.

### Characteristics

- Direct forces are measured due to the force sensor integrated in the ram. Insensitive against side forces
- Signal readings are not affected by outside interference
- A measuring data amplification integrated in the press head provides short transmission paths of unamplified signals
- Precision guide rails for precise working. Bilaterally adjustable, play-free gibs, precision machined bore for tool location. No die-set required



Press type 361

Press type 362

Press type 365

### Rapid approach stroke

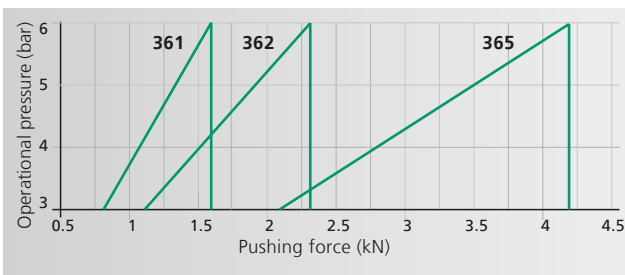

### Power stroke

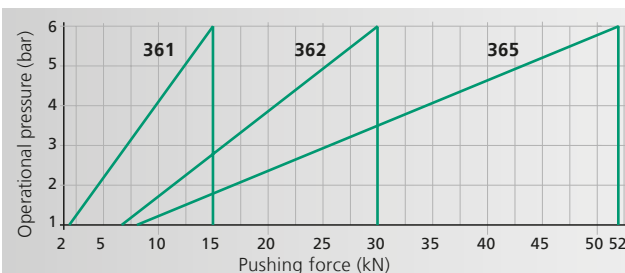

### Return stroke

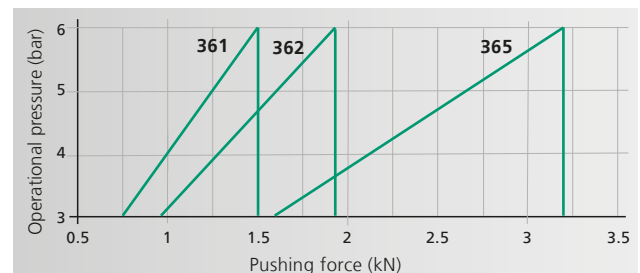

Operational pressure < 3 bar: can only be operated with press force preselector!

## From 15 kN to 52 kN in power stroke

Press Type		361	362	365
Total stroke - Power stroke <sup>1)</sup>	mm	50-6, 100-12	50-6, 100-12	50-6, 100-12
Nominal force at 6 bar	kN	15	30	52
Process data acquisition stroke force	µm/inc	5	5	5
	N/inc	4.5	9	15
Throat depth	<b>C</b> mm	131	160	160
Throat depth frame $\circ$		151		
Fixture mounting plate suitable for throat depth frame		$\circ$		
Ram bore	$\emptyset$ mm	20H7	20H7	20H7
External ram dimensions	<b>G x H</b> mm	70 x 50	90 x 60	90 x 60
Working height <sup>2)</sup>	<b>F</b>			
Frame No. 301	mm	160-355		
Frame No. 301-500 $\circ$	mm	310-500		
Frame No. 329	mm		130-300	130-300
Frame No. 329-460 $\circ$	mm		190-460	190-460
Weight (standard)	approx. kg	170	320	330

Frame Overview	Press Type	Frame Height M (mm)	Table Size B x T (mm)	Table Bore D $\emptyset$ mm	Table Height K (mm)	Mounting Surface B x L (mm)
No. 301	361	830	250 x 200	40H7	145	250 x 460
No. 301-500 $\circ$	361	990	250 x 200	40H7	145	250 x 480
Special fixture mounting plate with 3 longitudinal slots $\circ$			300 x 220 400 x 230	40H7		
No. 329	362, 365	810	300 x 230	40H7	147	300 x 550
No. 329-460 $\circ$	362, 365	990	300 x 230	40H7	147	300 x 620
Special fixture mounting plate with 3 longitudinal slots $\circ$			400 x 280 500 x 280	40H7		

### Options

$\circ$  Additional charge applies

<sup>1)</sup> Stroke variants on request

<sup>2)</sup> Typical values; can vary  $\pm 3$  mm due to casting and production tolerances

### Bottom view of the press head

Mounting drill pattern flange/ram

#### Press Type 361

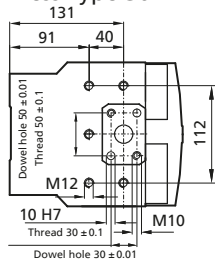

#### Press Type 362/365

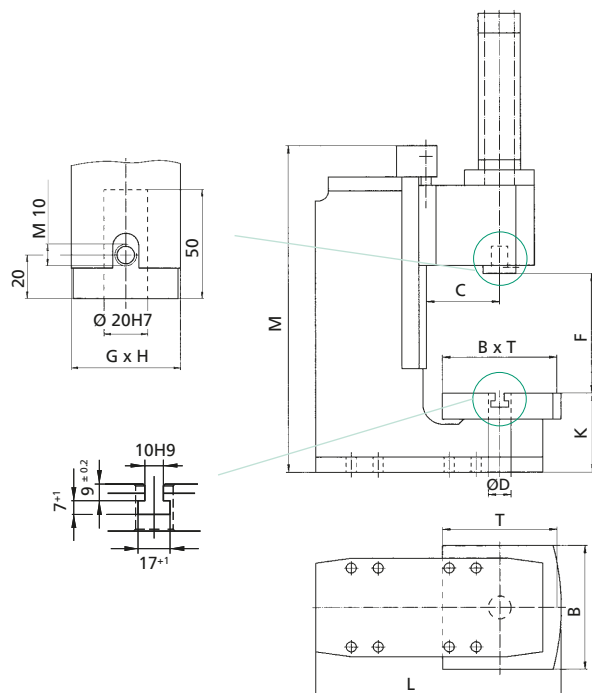
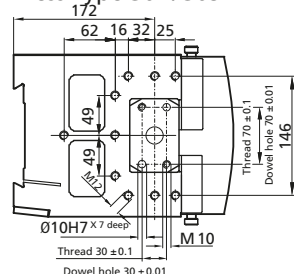

Detailed dimensional drawings can be downloaded: [www.schmidttechnology.de](http://www.schmidttechnology.de)

# SCHMIDT® HydroPneumaticPress

## In C-Frame design with force/stroke Monitoring

SCHMIDT® HydroPneumaticPress with force/stroke monitoring are offered as complete system with control unit SCHMIDT® PressControl 600. These systems are characterized by sensors and signal amplification integrated in the press head. These signals are evaluated in real time.

### Characteristics

- Direct forces are measured due to the force sensor integrated in the ram. Insensitive against side forces
- Signal readings are not affected by outside interference
- A measuring data amplification integrated in the press head provides short transmission paths of unamplified signals
- Precision bilaterally adjustable, play-free gibs, precision ground bore for tool location. No die-set required



Press type 364



Press type 368

### Rapid approach stroke

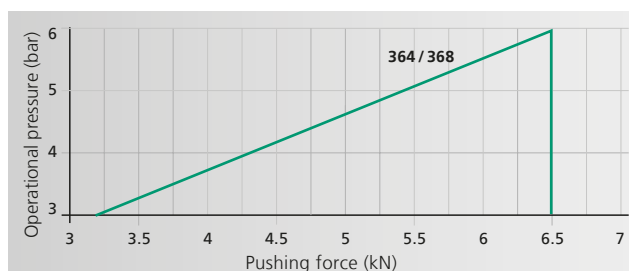

### Power stroke

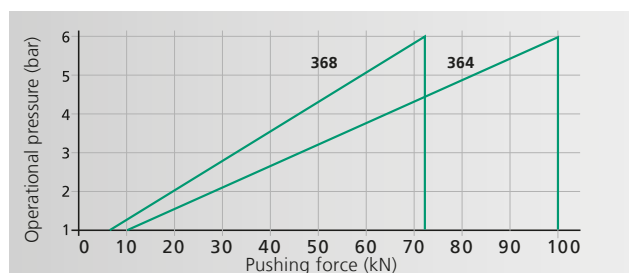

### Return stroke

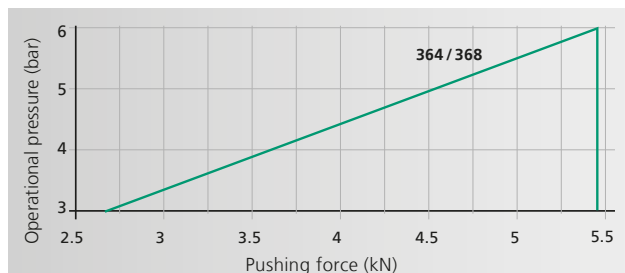

## From 72 kN to 100 kN in power stroke

Press Type		364	368
Total stroke - Power stroke <sup>1)</sup>	mm	50-6, 100-12	50-6, 100-12
Nominal force at 6 bar	kN	100	72
Process data acquisition			
Stroke	µm/inc	5	5
Force	N/inc	32	20
Throat depth	<b>C</b> mm	160	160
Ram bore	<b>E</b> Ø mm	25H7	20H7
External ram dimensions	<b>G x H</b> Ø mm	90 x 60	90 x 60
Working height <sup>3)</sup>	<b>F</b>		
Frame No. 64	mm	180-350	
Frame No. 64-600 o	mm	430-600	
Frame No. 68 <sup>2)</sup>	mm		130-300
Frame No. 68/5 <sup>2)</sup> o	mm		190-460
Weight (standard)	approx. kg	420	350

Frame Overview	Press Type	Frame Height M (mm)	Table Size B x T (mm)	Table Bore D Ø mm	Table Height K (mm)	Mounting Surface B x L (mm)
No. 64	364	940	400 x 290	40H7	185	400 x 625
No. 64-600 o	364	1200	400 x 290	40H7	185	400 x 685
No. 68 <sup>2)</sup>	368	810	300 x 230	40H7	147	300 x 550
No. 68/5 <sup>2)</sup> o	368	990	300 x 230	40H7	147	300 x 620
Special fixture mounting plate with 3 longitudinal slots o			400 x 280 500 x 280	40H7		

### Options

o Additional charge applies

<sup>1)</sup> Stroke variants on request

<sup>2)</sup> Frame 68/5 required for 30 mm power stroke

<sup>3)</sup> Typical values; can vary ± 3 mm due to casting and production tolerances

Bottom View of the Press Head  
Mounting drill pattern flange/ram

Press Type 364

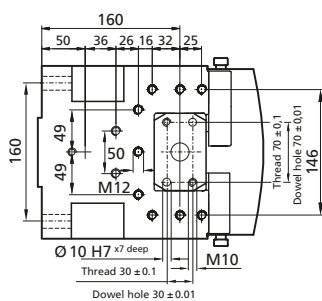

Press Type 368

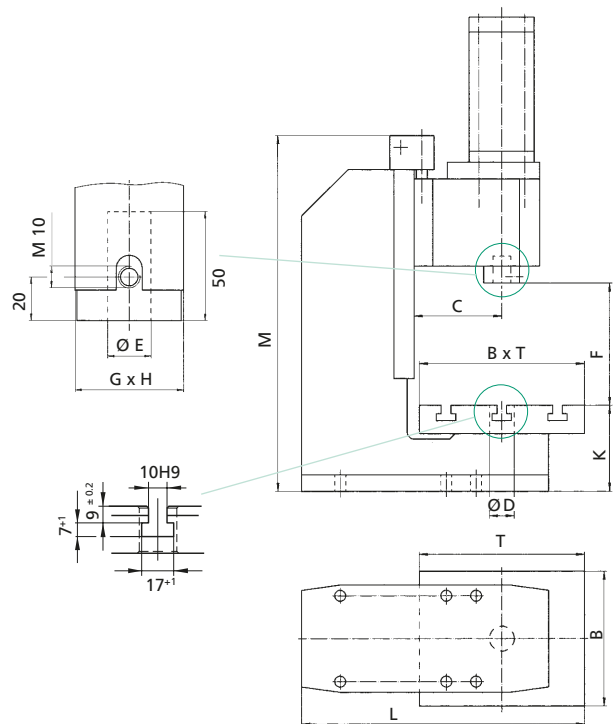
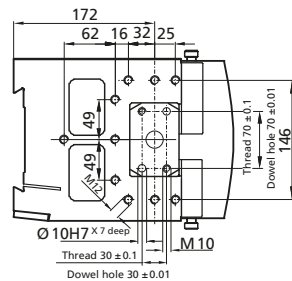

Detailed dimensional drawings can be downloaded: [www.schmidttechnology.de](http://www.schmidttechnology.de)

# SCHMIDT® HydroPneumaticPress

## H-Frame design with and without force/stroke monitoring



Press type 74/76  
374/376 (with force/stroke monitoring)

### Characteristics

- Stable frame with low bending for the absorption of high forces
- Flexible tool location in the fixture mounting plate due to replaceable centering bushing with precision bore
- The large working area offers sufficient space for large tools
- The force is determined via a pressure transducer with force/stroke monitored presses



Round ram locked against Rotation with TDC switch (74/76) or position measuring system (374/376) on the rotational guide rod.

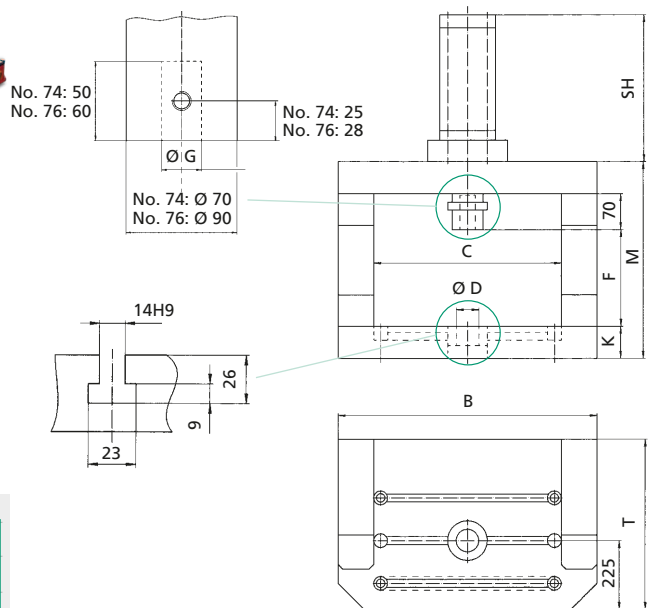

### Rapid approach stroke

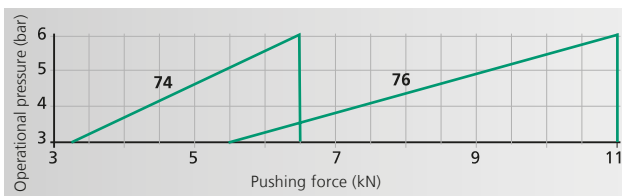

### Power stroke

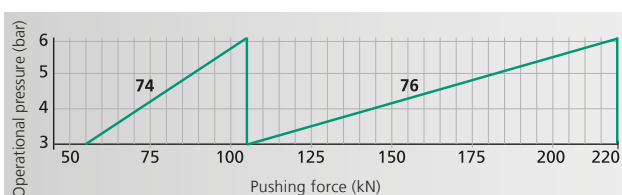

### Return stroke

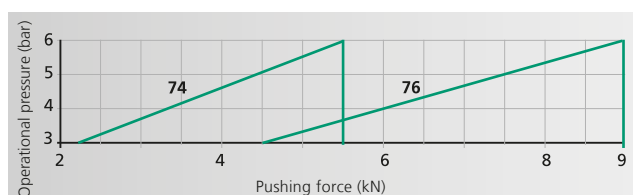

## From 100 kN to 220 kN in power stroke

Press Type			74	76
Total stroke - Power stroke <sup>1)</sup>		mm	100 - 12	100 - 12
Nominal force at 6 bar		kN	100	220
Ram bore	<b>G</b>	Ø mm	25H7	32H7
External ram dimensions		Ø mm	70	90
Working height <sup>2)</sup>	<b>F</b>		350	350
Table height	<b>K</b>	mm	95	95
Frame height	<b>M</b>	mm	640	640
Table size	<b>B x T</b>	mm	640 x 480	640 x 480
Table bore	<b>D</b>	Ø mm	40H7	40H7
Clearance	<b>C</b>	mm	420	420
Clearance o		mm	520	520
Weight (standard)		approx. kg	730	760

Press Type			374	376
Total stroke - Power stroke <sup>1)</sup>		mm	<b>100 - 12</b>	<b>100 - 12</b>
Nominal force at 6 bar		kN	100	220
Process data acquisition				
Stroke		µm/inc	5	5
Force		N/inc	32	62.5
Ram bore	<b>G</b>	Ø mm	25H7	32H7
External ram dimensions		Ø mm	70	90
Working height <sup>2)</sup>	<b>F</b>		350	350
Table height	<b>K</b>	mm	95	95
Frame height	<b>M</b>	mm	640	640
Table size	<b>B x T</b>	mm	640 x 480	640 x 480
Table bore	<b>D</b>	Ø mm	40H7	40H7
Clearance	<b>C</b>	mm	420	420
Clearance o		mm	520	520
Weight (standard)		approx. kg	730	760

### Options

o Additional charge applies

<sup>1)</sup> Stroke variants on request

<sup>2)</sup> Typical values; can vary  $\pm 3$  mm due to casting and production tolerances

### Accessories



#### High-pressure switch

After switching from rapid approach stroke to power stroke, the oil pressure rises in the hydraulic chamber of the cylinder. The high-pressure switch can be adjusted to reach a determined press force through the output generated by the oil pressure in the press.

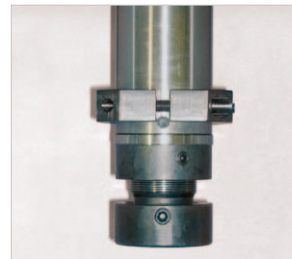

#### Adjustment bushing for SCHMIDT® HydroPneumatic-Press No. 74 and 76

For a simplistic adjustment of the working height with a setting range of 100 mm. This greatly reduces the need for spacers to accommodate different working heights during setup changes.



#### Oil pump

For an air-free refilling of the SCHMIDT® HydroPneumatic-Press with hydraulic oil, including 1 liter Hydraulic oil.



# SCHMIDT® Cylinder Units

For flexible use

**SCHMIDT®** Double-acting cylinder units are useful components for the construction of special machines. They can be mounted independently and are equipped with a magnet kit for detecting

the corresponding end position using a cylinder switch. As flange or side-mount model, with toggle transmission or as hydropneumatic cylinder unit in the force range up to 100 kN.



Press head (side-mount) model



Flange model



Technical Data	SCHMIDT® Cylinder Units	
Typ No.	Press head model	Flange model
20 - 29	•	•
32 - 36	•	
61 - 68	•	• (not for No. 61, 62, 65)
323 - 368	•	•

For the performance data, please refer to the chapters **SCHMIDT® PneumaticPress** and **SCHMIDT® HydroPneumaticPress**, optional with force/stroke monitoring.

## Order indications

Key for design options

<p>Cylinder Unit / Stroke / Design</p> <p>Order Example 65 - 50 - 6</p> <p>Press no. _____</p> <p>Total stroke _____</p> <p>Power stroke _____</p> <p>= <b>SCHMIDT®</b> Cylinder Unit No. 65 with total stroke 50 mm and power stroke 6 mm as press head model</p>	<p>Cylinder unit / stroke / design</p> <p>Order Example 20 - 50 - FL</p> <p>Press no. _____</p> <p>Stroke _____</p> <p>Model _____</p> <p>= <b>SCHMIDT®</b> Cylinder Unit no. 20 with stroke 50 mm as flange model</p>
--	--

# SCHMIDT® ElectricPress

## A new approach to assembly technology

To use electric drives instead of pneumatic or hydropneumatic driven cylinders, is a modern advancement in assembly technology. **SCHMIDT Technology** combined its proven rugged mechanics with the latest electric drive technology to create assembly presses for industrial production applications. The high efficiency of electric drives may not be the only reason to choose them. The individual process, the infrastructure and the quality of the compressed air should also have a bearing on that decision.

The key advantages of the **SCHMIDT® ElectricPress**:

- Easy programming of parameters reduces set-up time
- Stored press ram motion profiles allow for quick changeover
- Enhanced flexibility
- Reduced tooling costs and wear due to precise positioning
- The stick-slip effect does not occur due to our design. As a result the assembly process will be optimized compared to pneumatic drives, especially at low speeds
- Low noise level reduces operator fatigue and stress

An efficient and reliable assembly process is the key to the success of your products and hence success in competitive markets. The new **SCHMIDT® ElectricPress 345** with **SCHMIDT® PressControl 75** or **PressControl 700** improves production significantly:

- reduced assembly cost, due to the innovative electrical drive technology
- trustworthiness of its precise monitoring

The **SCHMIDT® ElectricPress 345** comes now with up to **10 kN** force and is based on proven system components. Designed for a durable automation technology the new **SCHMIDT® ElectricPress 345** will safeguard your success.

To meet the highest quality standards expected of a **SCHMIDT® Press**, the **SCHMIDT® ElectricPress 345** press system underwent a rigorous press-stroke test cycle continuously over a period of 4 months at a maximum force of 10 kN. All mechanical, electrical and motor elements have passed that stress test with flying colours.

- Process monitoring in real-time
- Extremely energy efficient
- Integration friendly
- Drive profile repeatability
- All-electric



# SCHMIDT® ElectricPress 43/45 with PressControl 75



SCHMIDT® ElectricPress manual workstation with SafetyModule on PU 20

SCHMIDT® PressControl 75 for quick set-up or rapid change-over and easy programming of press parameters; stores up to 24 datasets.

This combination can be used both in manual workstations as well as in automation solution.

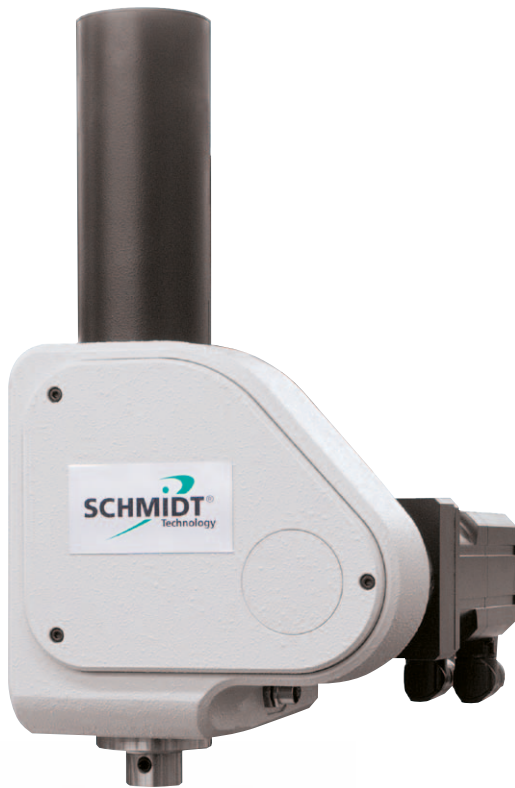

SCHMIDT® ElectricPress 43 automation

## Characteristics:

- Reproducible values for position, velocity, acceleration and deceleration
- Combination of up to 14 individual ram motion profiles into one complete profile by using a standard PLC
- Press to exact position (closed loop control stroke)
- Press to force (determined by motor current) to
  - press to final force
  - press to position but interrupt if force is exceeded
  - touch force to determine position of workpiece



# SCHMIDT® ElectricPress 343/345 with PressControl 700

In conjunction with the **SCHMIDT® PressControl 700**, the **SCHMIDT® ElectricPress** becomes a force/stroke monitored system. The continuous force control provides maximum precision and allows for realization of individual and complex displacement profiles for assembly processes.

**SCHMIDT® ElectricPress** utilises an integrated load cell. That means:

- Quickly reaching the nominal values
- No overshooting of the target values
- Precise positioning in the 1/100 mm range, even with dynamically changing force outputs
- The system works with predefined optimum acceleration values (no incorrect entries possible)
- Optimization of the processing times is possible due to an additional graphical display force/time [F/t], stroke/time [s/t] for an analysis of the behaviour of the process.



**SCHMIDT® ElectricPress 343 and 345** with the **SCHMIDT® PressControl 700** can be used both in manual workstations as well as in automation solutions.

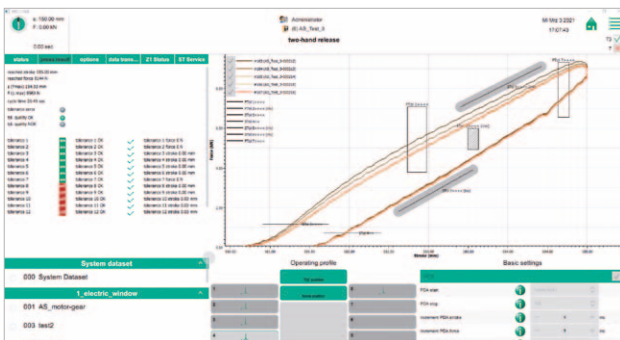

Process visualization



Optional:  
Integrated remote hand-wheel for set-up of  
- stroke control  
- force control

**SCHMIDT® ElectricPress 345**

Press Type			43	343	45	345
Force F max. <sup>1)</sup>		kN	4	4	10	10
Force F at 100 % duty cycle <sup>2)</sup>		kN	2,5 <sup>3)</sup>	2,5 <sup>3)</sup>	6 <sup>3)</sup>	6 <sup>3)</sup>
Ram stroke	A	mm	100	100	150	150
Ram speed max.		mm/s	200	200	200	200
Drive resolution		µm	< 1	< 1	< 1	< 1
Resolution PDA						
- Stroke		µm/inc		1,69		2,4
- Force		N/inc		1,25		3,0
Throat depth	C	mm	129	129	129	129
Decibel level		dB(A)	60	60	60	60
Power supply						
- Motor power			200 – 240 V AC / < 6 A	200 – 240 V AC / < 6 A	200 – 240 V AC / < 10 A	200 – 240 V AC / < 10 A
- Logic unit			24 V DC / 0,5 A	24 V DC / 0,5 A	24 V DC / 0,5 A	24 V DC / 0,5 A
Working height frame 7-420 <sup>4)</sup>			62 – 420	62 – 420	50 – 360	50 – 360
Working height frame 7-600 <sup>4)</sup>	F	mm	100 – 610	100 – 610		
S-H x S-B x S-T		mm	402 x 207 x 385	402 x 240 x 385	530 x 245 x 410	530 x 275 x 410
Weight		kg	35	35	59	59
PRC Gateway, number of I/O's				16 inputs / 16 outputs		16 inputs / 16 outputs

Frame Overview	Press Type	Frame Height M (mm)	Table Size B x T (mm)	Table Bore D Ø (mm)	Table Height K (mm)	Mounting surface (mm)
No. 7-420	43, 343, 45, 345	740	180 x 150	20 <sup>H7</sup>	90	220 x 362
No. 7-600	43, 343	960	180 x 280	20 <sup>H7</sup>	110	220 x 465

- 1) Temporary peak load
- 2) Nominal power in continuous operation
- 3) Minimum force for free positioning application is 400 N
- 4) Typical values; can vary ± 3 mm due to casting and production tolerances
- 5) Max. dimensions

Ram press type 43

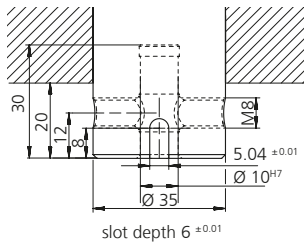

Ram press type 343

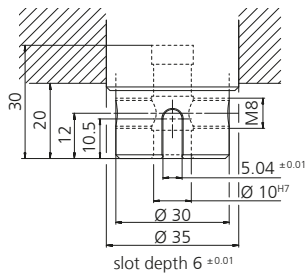

Ram press type 45

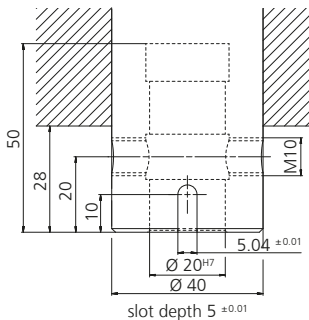

Ram press type 345

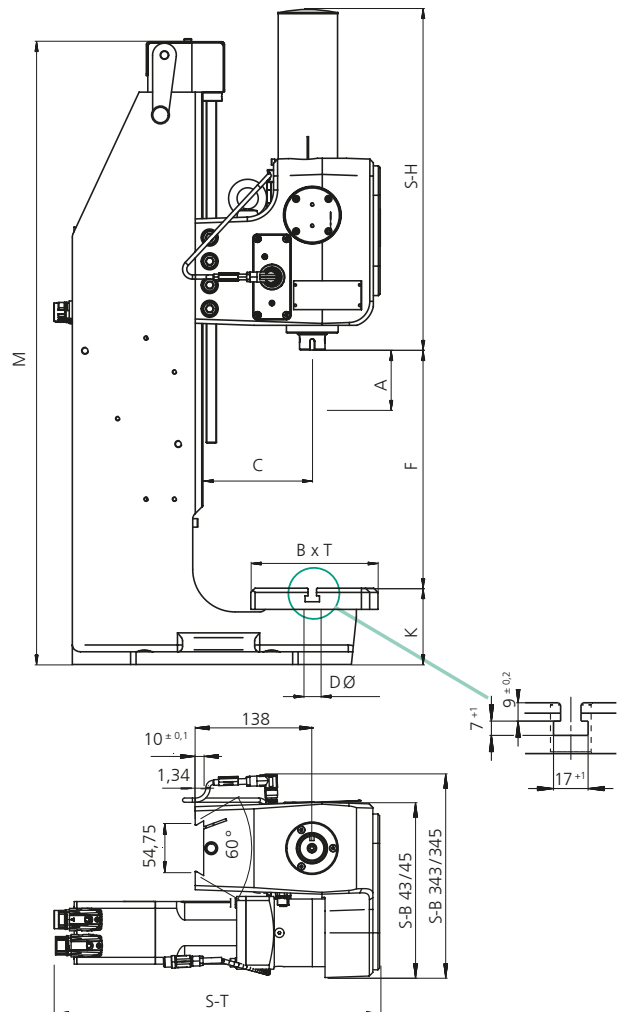
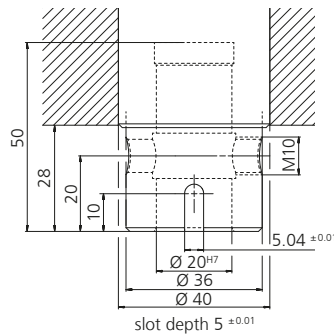

# SCHMIDT® ServoPress

Forces from 1 kN bis 250 kN



Press type 605

Press type 616

Press type 617

Press type 620

Press type  
650/655/660/680

Economical assembly is a decisive factor for the success of your product. The goal is to join precise assemblies from inexpensive individual components with high tolerances. Electrically driven presses – servo presses – are ideally suited for such tasks in terms of precision. The high-precision **SCHMIDT® ServoPress** systems offer them the perfect solution in the interaction of **SCHMIDT® ServoPress** modules and the **SCHMIDT® PressControl 700** or **PressControl 7000** control system developed for this purpose. These meet the most complex requirements, as "stand alone" machines or in automated production lines.

The full load resistant modules of the **SCHMIDT® ServoPress** series are **EC type tested** in combination with the safety technology options **SmartGate**, **SmartGuard** and **light curtain**. Furthermore, the servo presses have an integrated automatic spindle lubrication system and are protected by overload clutch from type 616 onwards.

# SCHMIDT® ServoPress

## Quality without compromise

The solid, unparalleled mechanics of the **SCHMIDT® ServoPress** are a basic prerequisite for precise joining results, even in the toughest industrial environments.

### Bench test

Before series production, new modules are subjected to a stress test under the toughest conditions. Not least, these tests result in many properties that benefit the applications.

Test over 20 million load cycles over the full working stroke with nominal force and lateral force components at full travel speed with a cycle time of approx. 2 seconds.

### Absolute, direct stroke measurement system

- Precise repeatability due to high system resolution
- Compensation of mechanical compressions under full load
- Compensation of pitch errors of the spindle
- Material length changes are eliminated as far as possible

### Full load resistant modules

- With nominal force at 100% duty cycle
- Over the complete ram stroke
- With short process times
- Via precise, low-backlash guidance of the ram
- Peak force in S3 mode

### Machine self-protection

- Fully automatic spindle lubrication
- Mechanical clutch as overload protection of the ServoPress in case of "crash"
- Active cooling with thermal monitoring of mechanics and electronics
- Current limitation when exceeding permissible load capacities
- Destruction by faulty operation is impossible

### Service friendly

- Low maintenance
- Easy module change due to a high precision ram 0-position.
- Module is automatically detected
- No changes to existing data sets

Built-in safety in the light curtain system, workplace protection with SmartGate or equipped with protective enclosure SmartGuard and of course EC type approved. From ServoPress 650/655/660/680 integrated energy management, intermediate storage of braking energy.

As a result, this means the following for your application:

- ✓ Excellent efficiency
- ✓ Maximum capacity
- ✓ High production safety



# Modules

With force outputs of 1 kN to 250 kN

Press type		605	616	617	620	650	655	660	680
Force F max. S3 25 %, 20 s	kN	1	5	14	35	75	110	160	250
Force F 100 % continuous run	kN	0.5	3	7.5	20	50	80	110	200
Ram stroke	mm	150	200	300	400	500	500	350	350
Resolution position control	µm	0.1	0.1	0.1	0.1	0.1	0.1	0.1	0.1
Ram speed	mm/s	0 – 300	0 – 200	0 – 200	0 – 200	0 – 200	0 – 100	0 – 100	0-50
Resolution PDA force	N/inc	0.3	1.5	3.75	10	24	32	48	75
Resolution PDA stroke	µm/inc	2.2	3.2	4.6	6.1	7.6	7.6	5.4	5.4
Overload protection		none	mechanical	mechanical	mechanical	mechanical	mechanical	mechanical	mechanical
Drive		ball screw			planetary roller screw				
Weight appr.	kg	11.6	25	64	113	225	225	283	283
Tool weight max.	kg	5	15	25	50	100	100	100	100
Power supply (50-60Hz)	VAC	200 – 240	200 – 240	400 – 480, 3~	400 – 480, 3~	400 – 480, 3~	400 – 480, 3~	400 – 480, 3~	400 – 480, 3~
Dimension H / W / D	mm	636 / 89 / 155	599 / 124 / 258	892 / 144 / 318	1077 / 190 / 384	1250 / 243 / 561	1250 / 243 / 561	1249 / 249 / 552	1249 / 249 / 552
Ram bore	mm	6 <sup>H7</sup>	10 <sup>H7</sup>	20 <sup>H7</sup>	20 <sup>H7</sup>	20 <sup>H7</sup>	20 <sup>H7</sup>	20 <sup>H7</sup>	20 <sup>H7</sup>
Ram dimension	mm	Ø 25	Ø 40	□ 42	□ 55	□ 65	□ 65	Ø 90	Ø 90

Overall dimensions with frame			605	616	617	620	650	655	660	680
Throat depth	<b>C</b>	mm	130	130	150	160	160	160	160	160
Table bore	<b>D</b>	mm	Ø 20 <sup>H7</sup>	Ø 20 <sup>H7</sup>	Ø 40 <sup>H7</sup>	Ø 40 <sup>H7</sup>	Ø 40 <sup>H7</sup>	Ø 40 <sup>H7</sup>	Ø 40 <sup>H7</sup>	Ø 40 <sup>H7</sup>
Working height (SP 680 in H-frame-version)	<b>F</b>	mm	246	300	387	518	612	507	500	500
Table height	<b>K</b>	mm	93	113	128	155	190	220	220	178
Table size	<b>B x T</b>	mm	160 x 140	220 x 175	250 x 200	300 x 200	370 x 230	370 x 230	370 x 230	370 x 230
Frame depth (SP 680 in H-frame-version)	<b>SL 6</b>	mm	365	405	460	563	636	725	761	614
Frame height (SP 680 in H-frame-version)	<b>SH 1</b>	mm	510	630	780	1080	1050	1050	1097	942
Total height	<b>SH 2</b>	mm	1015	1062	1467	1810	2012	2032	2036	2062
Weight appr.		kg	45	101	166	334	553	757	805	867

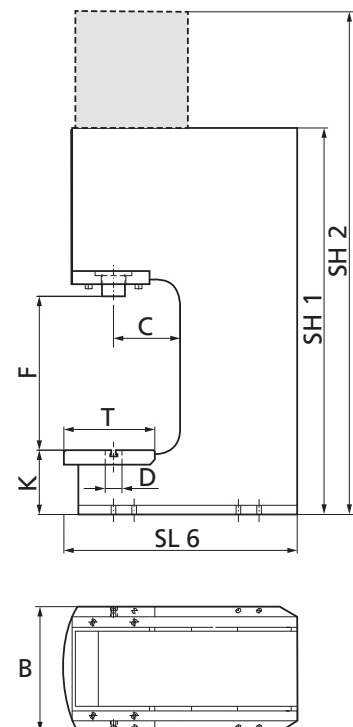



# SCHMIDT® ServoPress/TorquePress

## Superior controlled behaviour

The combination of a spindle with a servo drive is not sufficient to achieve optimum joining results. The key for intelligent assembly is quick and exact controlled behaviour of the press. This requires an integrated system consisting of drive unit, process measure-

ment technology and control unit. These requirements have been taken into account in the system architecture of a **SCHMIDT® ServoPress /TorquePress**.

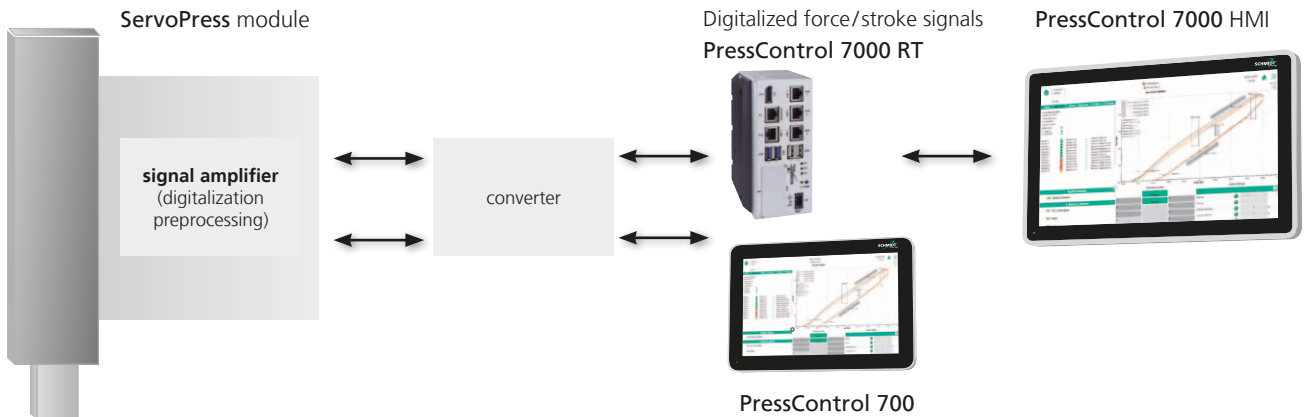

**SCHMIDT® ServoPress/TorquePress** modules operate with a true force control loop (force as a command variable).

That means:

- fast approach of the target values
- no overshooting of the target values
- precise positioning in the 1/100 mm range even with strongly fluctuating press-in forces
- highly accurate, continuous force control
- the control parameters can be adjusted
  - optimal adaptation to your application
  - no programming necessary
  - the system works with pre-set optimal acceleration values (no incorrect inputs possible)
- optimization of process times possible by additional graphical display. Force / time [F/t], and stroke / time [s/t] for analysis of the control behavior. The classic force / stroke [F/s] display of conventional electric axes is not comparable with the convenient recording and visualization options of the ServoPress / TorquePress
- stable closed loop force control over a long period of time
- no over or under oscillation (no vibrations) during the control process

These properties are achieved by combining the following features:

- integrated measurement technology (Sample rate 2000 Hz)
  - backlash-free displacement recording, force measurement without transverse forces
- amplification of the process signals at the **SCHMIDT® ServoPress** module
  - insensitive to electromagnetic interference (EMI)
  - closed-loop control takes place in **SCHMIDT® PressControl 700** or **PressControl 7000RT**, i.e. servo amplifier and motor receive the targets from the control system
  - optimized PLC control algorithm for external references
  - force [F], stroke [s] or other external reference parameters are processed simultaneously during the process.
  - the reference variables can be freely defined
- fast signal processing on software-based PLC with integrated CNC

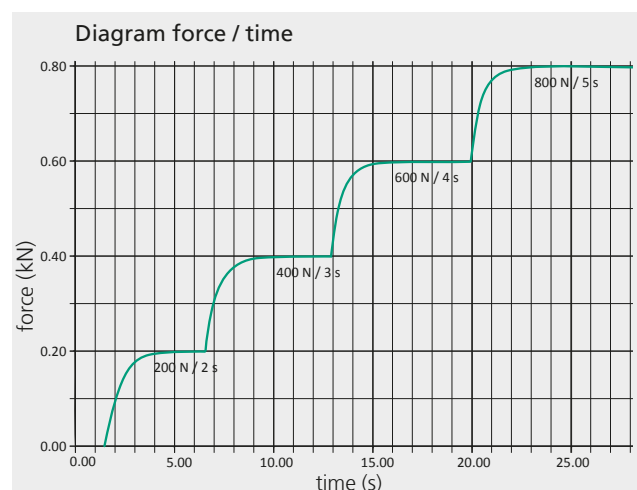

# SCHMIDT® TorquePress

## Precise dynamic

A number of special features characterizes the **SCHMIDT® TorquePress** in addition to the ServoPress series. Among other things, a hollow-shaft torque motor is used, which enables very high pressing forces due to the high motor torque without additional mechanical ratios.

Noise levels also remain remarkably low at all load conditions compared to other electric presses. The spindle nut, which is driven directly without the use of additional gears, enables very high efficiencies. Thanks to the hollow-shaft motor, the TorquePress is particularly compact and allows short overall lengths.

**SCHMIDT® TorquePress** are EC type approved in combination with the safety technology options SmartGate, SmartGuard and light curtain as well as optionally with the particularly economical 2-hand operation.

The solid, unparalleled mechanics of the **SCHMIDT® TorquePress** are a basic prerequisite for precise joining results, even in the toughest industrial environments.

### Bench test

Before series production, new modules are subjected to a stress test under the toughest conditions. Not least, these tests result in many properties that benefit the applications.

Test over 20 million load cycles over the full working stroke with nominal force and lateral force components at full travel speed with a cycle time of approx. 2 seconds.

### Absolute, direct stroke measurement system

- Precise repeatability due to high system resolution
- Compensation of mechanical compressions under full load
- Compensation of pitch errors of the spindle
- Material length changes are eliminated as far as possible

### Full load resistant modules

- With nominal force at 100 % duty cycle
- Over the complete ram stroke
- With short process times
- Via precise, low-backlash guidance of the ram
- Peak force in S3 mode

### Machine self-protection

- Fully automatic spindle lubrication
- Mechanical clutch as overload protection of the ServoPress in case of "crash"
- Active cooling with thermal monitoring of mechanics and electronics
- Current limitation when exceeding permissible load capacities
- Destruction by faulty operation is impossible

### Service friendly

- Low maintenance
- Easy module change due to a high precision ram 0-position.
- Module is automatically detected
- No changes to existing data sets

Built-in safety in the light curtain system, workplace protection with SmartGate or equipped with protective enclosure SmartGuard and of course EC type approved.

TorquePress 560 with **integrated energy management**, intermediate storage of braking energy

As a result, this means the following for your application:

- ✓ highest efficiencies
- ✓ maximum machine availability
- ✓ very high production reliability



TorquePress 520



TorquePress 560

# Modules

With force outputs of 20 kN to 100 kN

Pressentyp		TorquePress 520	TorquePress 560
Force F max. S3 25%, 20 s	kN	20	100
Force F 100 % continuous run	kN	10	50
Ram stroke	mm	250	300
Resolution position control	µm	< 1	< 1
Ram speed	mm/s	0 – 260	0 – 200
Resolution PDA force	N/inc	6,25	30
Resolution PDA stroke	µm	4	4,6
Overload protection		electrical	mechanical
Drive		ball screw	planetary roller screw
Weight appr.	kg	95	230
Tool weight max.	kg	25	100
Power supply (50 – 60Hz)	VAC	400 – 480, 3~ / 16 A	400 – 480 V 3~ / 32 A
Dimension H / W / D	mm	1132 / 163 / 315	1438 / 304 / 255
Ram bore	mm	∅ 20 <sup>H7</sup>	∅ 20 <sup>H7</sup>
Ram dimension	mm	∅ 50 <sup>H6</sup>	∅ 60 <sup>H6</sup>



TorquePress 560 with SmartGuard and PressControl 7000 RT/HMI on PU40

Overall dimensions with frame			TorquePress 520	TorquePress 560
Throat depth	C	mm	160	160
Table bore	D	mm	∅ 40 <sup>H7</sup>	∅ 40 <sup>H7</sup>
Working height	F	mm	340	420
Table height	K	mm	132	180
Table size	B x T	mm	300 x 230	370 x 230
Frame depth	SL 6	mm	530	620
Frame height	SH 1	mm	670	880
Total height	SH 2	mm	1662	2098
Weight approx.		kg	222	584

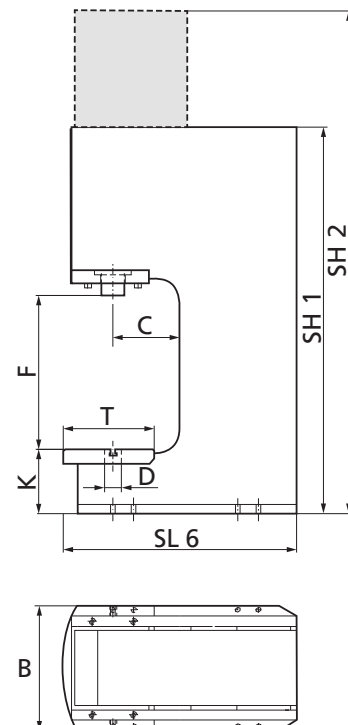

Detailed dimensional drawings can be downloaded:  
[www.schmidttechnology.de](http://www.schmidttechnology.de)

# Dynamic bend up compensation

## Patented feature

In order to achieve assembly requirements in the 1/100 mm range, compensation of the system yield is required. Work piece, tooling and machine are elastically deformed by the varying forces induced during the pressing process. Once the operation is complete and the press force is removed, this deformation disappears. The result is that the assemblies are not joined to their programmed dimensions. This yielding effect makes it impossible to produce high precision joints regardless of a systems positioning accuracy.

First, a complete process representation of the force characteristic in loaded and unloaded state is necessary so that the system can carry out the required compensation.

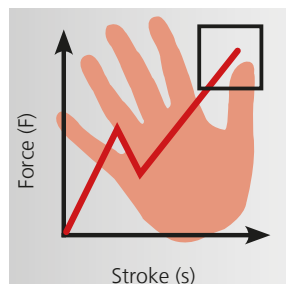

Conventional procedures end in the block position – but the process is not finished yet. The system is under force.

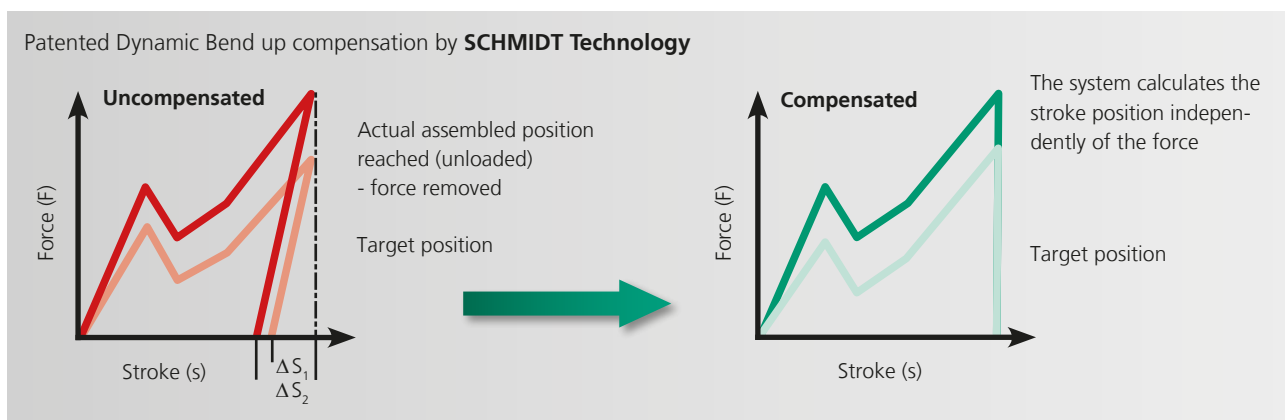

In typical applications, the force required to complete an assembly varies up to 40 % from part to part. When freely positioning, such as without a positive stop, the press ram extends to the same target position, regardless of load. But a closer inspection of the completed assembly and the force/distance curve generated, shows that the final pressed position will vary due to the

forces in the operation. (figure 1) In order to overcome this effect, **SCHMIDT® ServoPress/TorquePress** systems compensate dynamically to the changing forces. This compensation allows for the assembly to be pressed to the target position, regardless of force (figure 2)

- The **SCHMIDT® ServoPress/TorquePress** system determines easily and precisely the system elasticity and compensates it dynamically in real time
- Only with dynamic bend up compensation, the end position can be reached to an accuracy of the 1/100 mm range
- Free positioning with compensation of the system elasticity is more accurate than pressing on effect tool stop
- Dynamic bend up compensation does not reduce the process speed
- Dynamic bend up compensation in connection with other intelligent functions, such as offset of tolerance data, has been patented

### Example: Press in a Pin in a Bushing

The elasticity of an assembly depends on the equipment, process and the component geometries. This effect becomes significant for assemblies with which the assembly forces of the individual components differ strongly from one another. This can particularly be seen in the example shown.

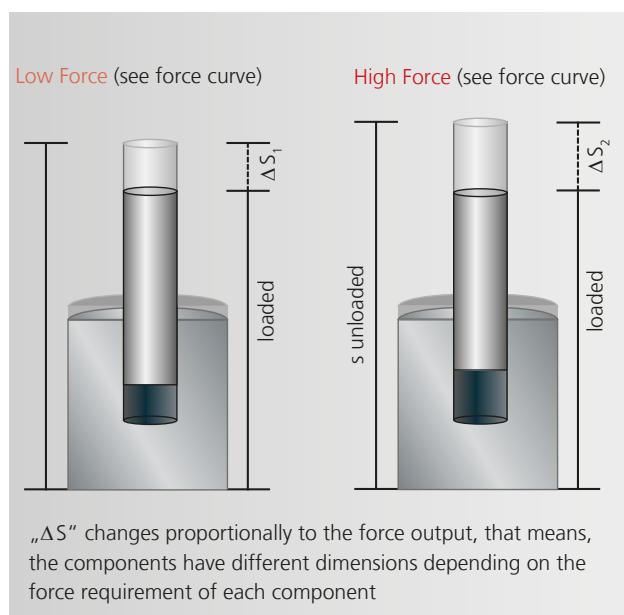

# SCHMIDT® Single Workstations

## Ergonomics with certified safety technology

SCHMIDT® workstations are supplied ready for purpose with certified safety technology and corresponding operating elements. Depending on customer requirements, workstations can be equipped with the following security concepts:

- SCHMIDT® SmartGuard protection cover
- SCHMIDT® SmartGate protective housing with automatic doors
- light curtain
- two-hand safety

The delivery includes:

- Module SCHMIDT® presses mounted on stand or pedestal
- SCHMIDT® PressControl 75 (in two-hand release and light curtain versions), 700 or PressControl 7000 with pendant arm system
- Press base PU 20 / PU 40 in rigid or height-adjustable design, depending on the safety concept optional or as standard

All systems are EC type-approved!

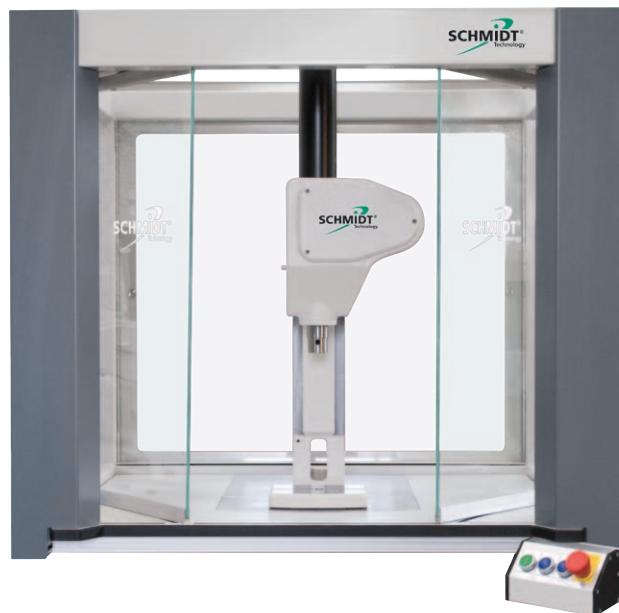

# SCHMIDT® SmartGate

## Shorter process cycles and increased safety standards

SmartGate is a protective enclosure with automatic doors. The access to the process area is via two transparent, horizontally guided door elements. Key benefits of SmartGate over other safety concepts, such as light curtain or two-hand systems, are the significant increase in ergonomics and workflow efficiency through reduction of required safety margins and the excellent accessibility of the process space.

SmartGate sets new standards in the field of safety by completely closing of the process area, completely eliminating unintentional third-party intervention or fragmentation. SmartGate is particularly suitable for processes with the risk of splintering due to protection against flying parts or spalling.

When designing SmartGate, we ensured that all surfaces are as easy to clean as possible and that there are no areas where residues or particles can accumulate. High demands on purity and cleanliness, as they occur, for example, in applications in medical technology can therefore be easily met.

SmartGate		
Max. opening width	720	mm
Variable speed	50 – 350	mm/s
Typical opening time	2.2 s	
Typical closing time	1.8 s	
Noise emission	< 60	dB(A)
Cell size 1	1010 x 883	mm
Cell size 2	1010 x 1049	mm
Protective door	laminated safety glass (VSG)	
Safety category	Ple	



### Characteristics

- Protection of the working area from unintentional intervention
- Splinter protection from chipping of parts
- Visible working space
- Optimization of the safety distances to the complete danger area
- Consideration of quality assurance requirements (NIO behaviour)
- Cycle time and process optimization through programmable opening and closing speed (<2 s)
- Very high energy efficiency due to linear motor drive
- Type approved

# SCHMIDT® Safety Technology

## Smart Safety Concept for Servo and Torque presses

The transparent protective housing entirely encloses the working area during the press process. It thus prevents the user and a third person from getting their hands into the danger area and efficiently protects against the particles or splinters that may be ejected. The distances to the working zone are minimized which considerably improves the ergonomics and the efficiency of the workstations. The high dynamics of the protective housing with numerical control and its variable positioning capability and traversing velocity optimize the process cycle. The smart construction prevents any trap points in the enclosure.

**SCHMIDT® SmartGuard** is a protective shield for **TorquePress 520**, **TorquePress 560** and **ServoPress 605 to 620**.

SmartGuard	type	SP 605	SP 616	SP 617	SP 620	TP 520
Variable opening stroke	mm	280	350	410	500	390
Speed opening	mm/s	200 - 1000				
Speed closing	mm/s	200 - 500				
Drive	type	linear motor				
Min. cycle	s	6				
Deep	mm	434	485	573	644	599
Wide	mm	232	286	312	359	343
Height	mm	1018	1111	1440	1840	1640
Locking position <i>closed</i>		active				
Material guard	PC	antistatic / transparent				
Electr. safety lock		Ple				

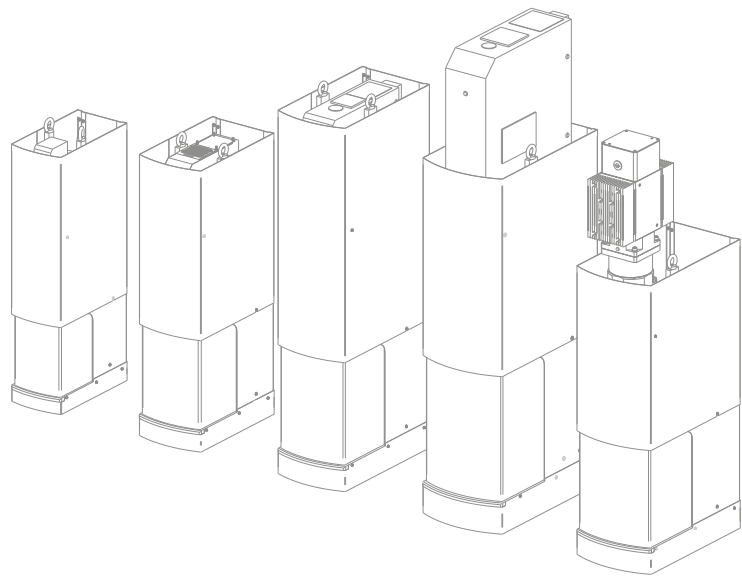

### Characteristics

- Protection of the working area from unintentional intervention
- Splinter protection from chipping of parts
- Visible working space
- Optimization of the safety distances to the complete danger area
- Consideration of quality assurance requirements (NIO consideration)
- Cycle time and process optimization through programmable opening and closing speed (<2 s) and the opening height
- Very high energy efficiency due to linear motor drive
- Type approved
- ESD version possible

# SCHMIDT® PressControl Machine control units

SCHMIDT® PressControl 75, 700 and 7000 are control units of the latest generation, which allow the design of modern production processes – from the single workstation to complete automation. You benefit from our competence in:

- safety technology – EC type approved machines
- process measurement technology – simultaneous measurement technology in the process
- process documentation

The control systems have the following features:

- efficient due to intuitive user interfaces on touch / multi-touch screen
- fast and safe setup of processes in a clearly arranged window, simple parameterization for manual ram movement and transfer of the actual parameters force and path to the motion blocks (teach-in) for the PressControl 700 and 7000 controls in combination with ServoPress/TorquePress/ElectricPress
- the integrated PLC allows the control of additional inputs/ outputs or sensors/actuators and thus the application-specific set-up of the workstation or system
- the integrated measurement data acquisition is insensitive to interferences (EMC). This results in a high measurement reliability of the entire system
- with the integrated safety technology, the entire system becomes an EC type-approved single workstation
- service functions enable simple and efficient maintenance
- guarantee of complete process documentation with clearly traceable component assignment

SCHMIDT® PressControl 75



SCHMIDT® PressControl 7000 RT



SCHMIDT® PressControl 700



SCHMIDT® PressControl 7000 HMI





# SCHMIDT® PressControl 75

## Compact functionality

Highly compact yet multifunctional **SCHMIDT®** PressControl 75 available for these press systems:

- **SCHMIDT®** ElectricPress
- **SCHMIDT®** PneumaticPress
- **SCHMIDT®** HydroPneumaticPress

Its easy and intuitive touchscreen allows for quick and efficient process set-up or change-over. Process specific data can be stored in up to 24 datasets.

The **SCHMIDT®** SafetyModule allows the design of single workstations with safety technology that meets the latest global standards for two-hand cycle initiation, guarding or light-curtain protection.



Technical Data	
Supply voltage	24 V DC
Current	< 3 A
Operating temperature	0 – 40 °C
Protection class	IP 54
Interfaces	<ul style="list-style-type: none"> <li>■ CANopen for PRC -Gateway or CANopen Compact Box IP 2401</li> </ul>
Electrical connections	All connections are pluggable
Display	<ul style="list-style-type: none"> <li>■ 2.8" touch screen</li> <li>■ Process information</li> </ul>
Operation	<ul style="list-style-type: none"> <li>■ 4 function keys</li> <li>■ 3 languages, switchable</li> </ul>
Modes of operation	<ul style="list-style-type: none"> <li>■ Two-hand release with SafetyModule</li> <li>■ Light curtain with SafetyModule</li> <li>■ Start button for operation without SafetyModule</li> <li>■ Workpiece control</li> <li>■ Activation of sliding table</li> <li>■ Return stroke initiation with external signal</li> <li>■ Blow-out/blow-off</li> </ul>
Operating functions	<ul style="list-style-type: none"> <li>■ Piece- or preselection counter</li> <li>■ Set-up mode</li> <li>■ BDC dwell time</li> <li>■ User Management</li> </ul>
Dimensions	90x120x60 (h x w x d)
Mounting	Fastening screws, optional magnet holder

>>press parameter<<
presstime endposition 0,5 s
>>counter<<
preselect counter off
preselect quantity 10 pcs

Data input

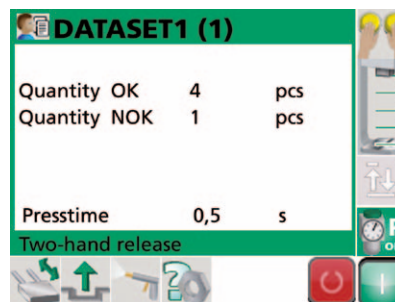

Data output

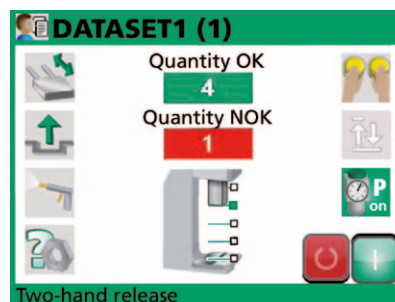

Data output

# SCHMIDT® PressControl 700

## "All in one" control and visualization for the single workstation

The **SCHMIDT® PressControl 700** for single workstations for the control and monitoring of pressing and joining processes. In addition to precise assembly tasks, the fast acquisition of extensive process data and bidirectional data exchange is becoming more and more important.

The **SCHMIDT® PressControl 700** real-time controller communicates with the process components via the high-performance and fast field bus EtherCAT with a transmission rate of 100 Mbit/s and a transmission speed of 0.5 ms. With this the press control meets the requirements for fast processing of large data volumes. The leap into other fieldbus worlds is realized by using optional fieldbus gateways.

Process visualization takes place directly on the PressControl 700. Via the Ethernet interface, the control communicates with MES systems and external PCs as well as PRC DataBase and PRC FileX-change software.

The press control system is optimally designed for **SCHMIDT® press systems**. Thanks to the integrated PLC, process visualization, the best possible compatibility and performance is achieved. All components are tested and matched to each other in the network and are therefore ready for immediate use.

### User Surface

- 10,1" Full HD multi-touch-screen
- setup and setting of parameters via "drag & drop"
- compact display of the entire process in the home view
- individual sizing of the process windows (splitter function)
- language switchable

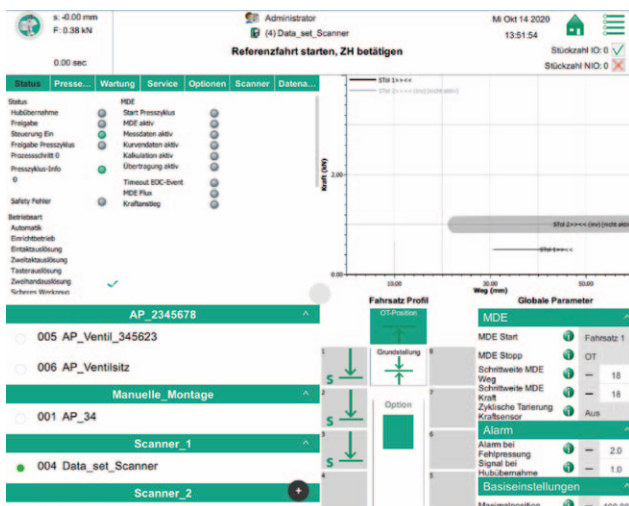

### Technical Data

Industrial PC	Intel E3990 processor 2 GB main memory 16 GB on-board Flash (eMMC) 4 GB CFAST Linux operating system
Schnittstellen	2 x USB 2.0 2 x USB 3.0 1 x Ethernet, M12 (LAN1) 1 x Ethernet, M12 (LAN2) 1 x EtherCAT-P, M8
Power supply	24 V DC (EtherCAT-P)
Stromaufnahme	max. 1,3 A
Weight	ca. 1,9 kg
Umgebungstemperatur	0 °C ... +40 °C
Luftfeuchtigkeit	0 ... 90 % relative Feuchte (nicht kondensierend)
Schutzart	IP 54

# SCHMIDT® PressControl 7000

## Compact system control for intelligent process control

The **SCHMIDT® PressControl 7000 RT** for single workstations for the control and monitoring of pressing and joining processes. In addition to precise assembly tasks, the fast acquisition of extensive process data and bidirectional data exchange is becoming more and more important.

The **SCHMIDT® PressControl 7000 RT** real-time controller communicates with the process components via the high-performance and fast field bus EtherCAT with a transmission rate of 100 Mbit/s and a transmission speed of 0.5 ms. With this the press control meets the requirements for fast processing of large data volumes. The leap into other fieldbus worlds is realized by using optional fieldbus gateways.

Process visualization takes place directly on the PressControl 7000. Via the Ethernet interface, the control communicates with MES systems and external PCs as well as **PRC DataBase** and **PRC FileXchange** software.

The press control system is optimally designed for **SCHMIDT® press systems**. Thanks to the integrated PLC, process visualization, the best possible compatibility and performance is achieved. All components are tested and matched to each other in the network and are therefore ready for immediate use.

### SCHMIDT® PressControl 7000 HMI

- 21.5" Full HD multi-touch screen
- Multi-axis applications can be visualized
- Setup and setting of parameters via "drag & drop"
- Installation of optional software tools such as **SCHMIDT® PRC DataBase** or **PRC FileXchange** is prepared



Technical Data PressControl 7000 RT	
Industrial PC	Intel E3990 Processor 2 GB main memory 16 GB on-board flash (eMMC) 4 GB CFAST Linux operating system
Interfaces	1 x display port 2 x USB 2.0 2 x USB 3.0 3 x Ethernet, RJ45 (LAN1 via integrated switch on 3 ports) 1 x Ethernet, RJ45 (LAN2) 1 x EtherCAT, RJ45 Universal Fieldbus, integrated compartment for installation
Power supply	24 V DC (via 3-pin plug)
Current consumption	1 A
Weight	approx. 0.73 kg
Ambient temperature	0 °C ... +65 °C
Storage temperature	-20 °C ... +70 °C
Humidity	0 ... 90 % relative humidity (non-condensing)
Protection class	IP 20; PressControl 7000RT in the switch cabinet

Technical Data PressControl 7000 HMI	
Industrial PC	Intel i5-7xxx Processor 64 GB CFAST operating system 512 GB HDD data memory Operating system Windows 10
Monitor	21.5" full HD monitor (1920 x 1080) with capacitive multi-touchscreen
Interfaces	1 x HDMI 2 x USB 2.0 2 x GBit Ethernet, M12, X-coded (LAN1, LAN2) 2 x integrated speaker
Power supply	24 V DC (via 4-pin M12 plug, T-coded)
Current consumption	2 A
Weight	approx. 9.5 kg
Ambient temperature	0 °C ... +40 °C
Storage temperature	-20 °C ... +60 °C
Humidity	5 ... 90 % relative humidity (non-condensing))
Protection class	IP 54
Mounting	VESA 75

# User surface for professional assembly

## For PressControl 700 and 7000

The user interface for professional assembly is installed in the **SCHMIDT® PressControl 700 and 7000**. The functionality has been developed specially for assembly operations with immediate reaction in the process.

The following functions are available

- process visualization
- process data management
- development tool (PLC editor)
- **SCHMIDT® PRC DataBase, PRC FileXchange, PRC OPC** optional

### Process Monitoring

- high graphical curve resolution for detailed view of curve segments
- three graphic displays; force/stroke, force/time and stroke/time for process analysis and optimization
- extensive tool library
- result visualization OK/NOK (green/red)
- tolerance observers

### Process Output

Actual system statuses are displayed both text-oriented and graphically and thus enable a transparent process overview for quick analysis and troubleshooting.

### Software Options

The comprehensive software packages for process data management and process optimization can be activated individually and specifically stored in data sets.

### Characteristics

- easy and fast setting of parameters for the processes
- definition of data sets and motion profiles by parameter setting
- process optimization by switching the process display (F/s, F/t, s/t)
- easy definition and evaluation of processes via quality observers
- 12 QA observers can be defined as F/s windows or stroke tolerances as required
- safe detection of bad parts (NOK)
- Clear documentation and part assignment
- software PLC to freely program sequences
- service functions for diagnosis and system updates

### User Interface SCHMIDT® PressControl 700

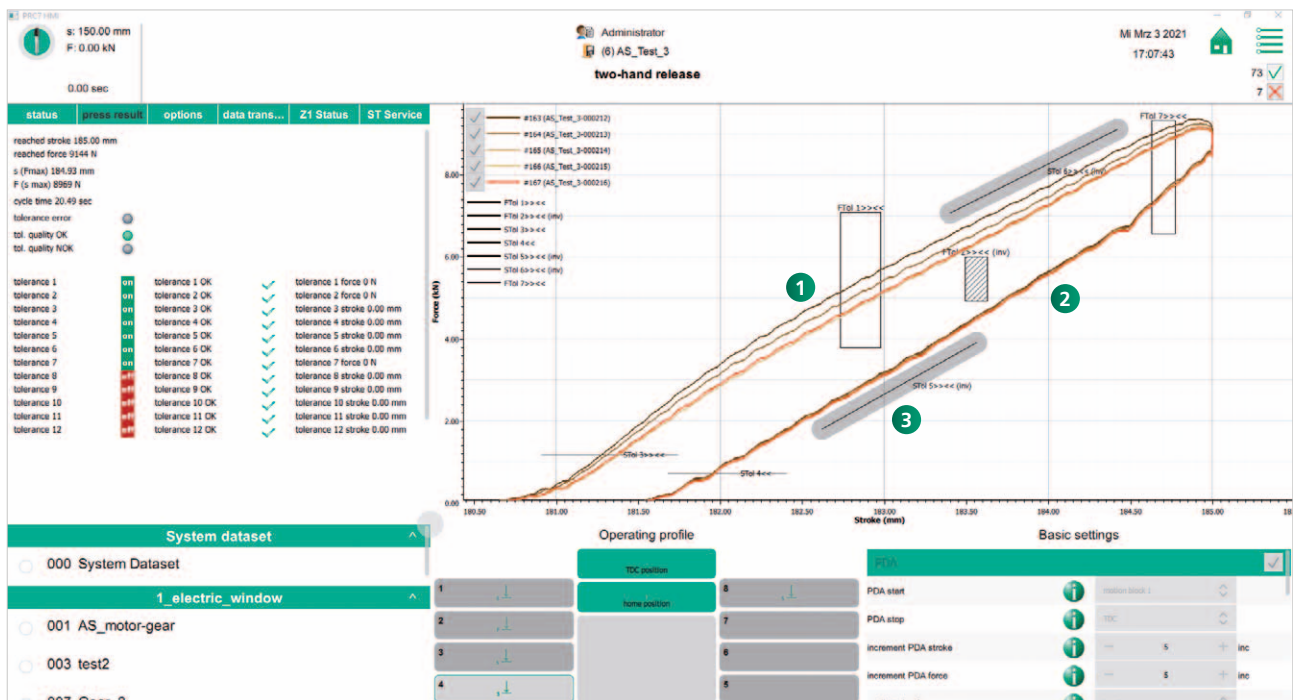

1 + 2 All tolerances can also be used inverted (blocking ranges) 3 Stroke tolerances can be adapted to curve gradient

# SCHMIDT® ServoPress/TorquePress

## Driving profiles and applications

SCHMIDT® ServoPress / TorquePress enable simple configuration of the driving profiles with motion blocks. In order to realize a quick setup, different standard driving profiles are available.

Experience shows that these standard driving profiles and combinations cover most applications. Up to 8 motion blocks can be combined as desired.

### Positioning to "stroke"

Normal driving profile, typically combined with bending compensation.

### Closed loop "force" control

For processes in which the force achieved is a measure of the process quality, e.g. material compressing processes.

### Driving on touch force and "delta stroke"

For processes in which component tolerances must be reached. The press scans the surface and presses in to a specific differential dimension as soon as the defined force is reached.

### Driving on "Force increase"

The return stroke is initiated at a defined force increase (slope)

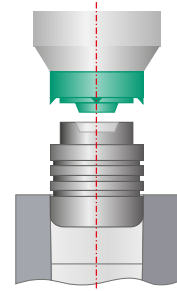
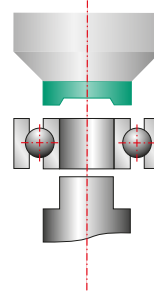
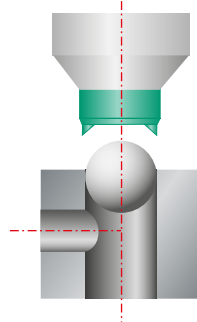
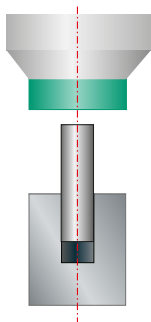
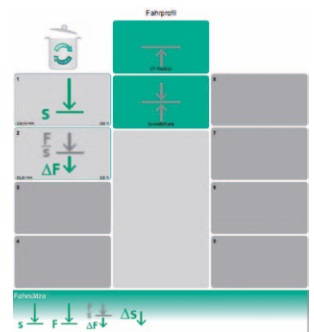
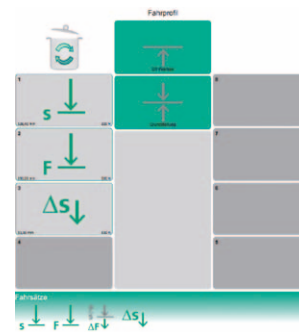

Pressing until reaching a specified position leads to precise results in connection with bend up compensation.

Plugging blind bores – a sphere is pressed in and crimped. Force output correlates to material displacement to determine density and retain force independent of stroke or the safe seating of bearings on shafts

Pressing to a functional dimension with force-controlled touching of the body edge and subsequent relative movement (delta stroke)

Pressing in expanders or crimping cable shoes. The sealing or holding function depends on the correlation of force and displacement.

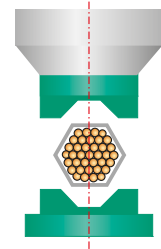
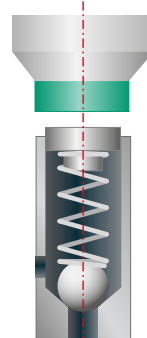
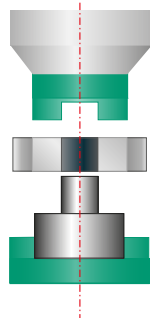
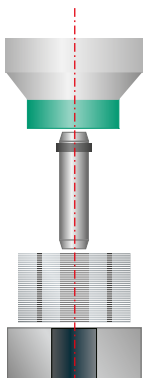

# Visualization and process analysis for PressControl 700 and 7000

## Visualization user surface

Important parameters for assessing the quality of press fits are the press force and the press stroke. The data of these measured variables are recorded during the process and displayed by the software as a force-displacement curve  $F/s$  or  $F/t$  or  $s/t$ .

For quality assurance of the joining process, freely definable tolerances are provided in the form of force-stroke windows and stroke tolerances. With the help of these criteria, the quality-critical areas can be precisely monitored. If the tolerances are not adhered to in the monitored curve areas, appropriate application-specific reactions can take place (e.g. selection measures).

Tolerance criteria can be created very easily and progression curves can be displayed exactly. Not only the working stroke but also the return stroke are important for the evaluation of the curves. The high resolution of our measuring systems allows a large number of measuring points, which are necessary for a process-reliable evaluation. Integrated zoom and measurement functions allow detailed statements on the joining processes.

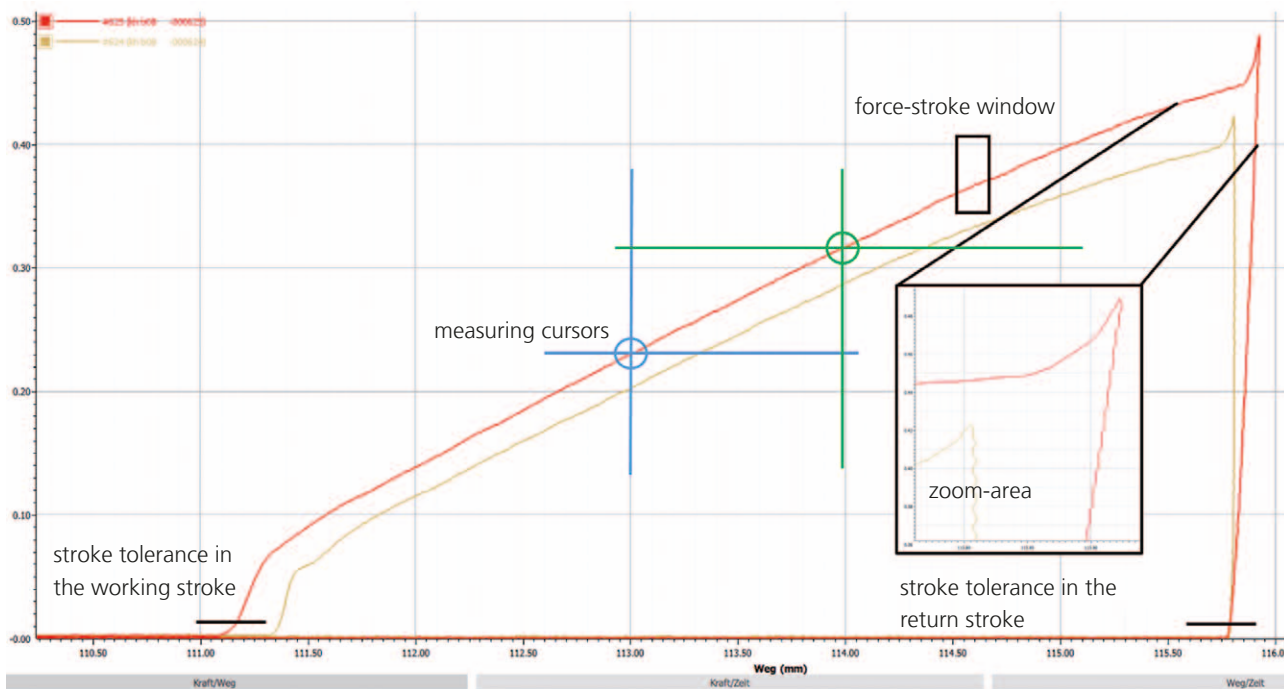

Process analysis – graphic display force over stroke

## SCHMIDT® MoveTol

Patented offset of tolerance, data software for PressControl 700 and 7000

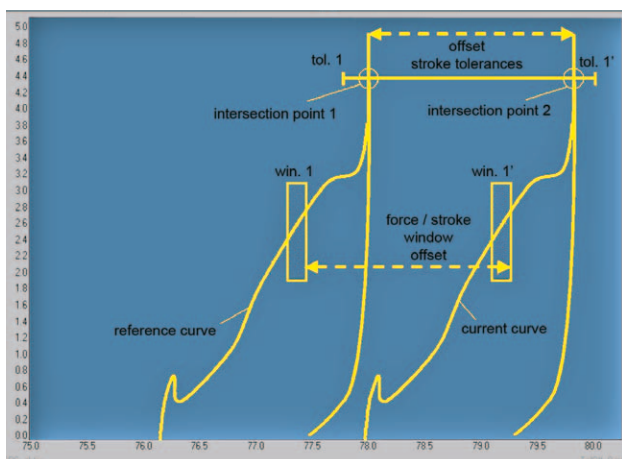

Assembly parts are subject to certain manufacturing tolerances. Height deviations of the parts result in an offset of the curves in the curve window. The curves of the parts with larger tolerance deviations can then lie outside the created tolerance limits and are declared as bad parts.

The height tolerances of the parts can be taken into account with the "Tolerance data offset" function. The defined tolerance windows and stroke tolerances are shifted by the distance to a reference position. The good/bad evaluation is then performed.

Offset of the tolerance data is relative to freely selectable references.

# SCHMIDT® Software-Tools

## Interface for data evaluation and control

To cover the versatile requirements in the field of data management, **SCHMIDT Technology** offers modular software tools. It includes possibilities in the area of machine control, data storage and exchange as well as visualization and analysis. This enables versatile requirements of quality assurance, traceability and optimization of production processes can be realized. A large number of up-to-date interfaces are available at Fieldbus level and allow the press system to be easily integrated into higher-level systems.

The data obtained during the pressing process allows conclusions to be drawn about quality fluctuations in components or even preliminary processes in production. Therefore, not only data acquisition and storage, but also analysis and but also analysis and evaluation play a central role. **SCHMIDT® PRC DataBase** and **PRC FileXchange** offer a wide range of options for this purpose. An evaluation can be carried out either with on-board tools or by user IT systems to which the process results are transferred.

### Ethernet

### Fieldbus



# SCHMIDT® PRC DataBase

## Database software for PressControl 700 and 7000

**SCHMIDT® PRC DataBase** is an optional software for the modular control system **SCHMIDT® PressControl 7000** or **SCHMIDT® PressControl 700**. The database software is used for storing and analysing the data of the control system – process specifications and process results – particularly under quality assurance aspects.

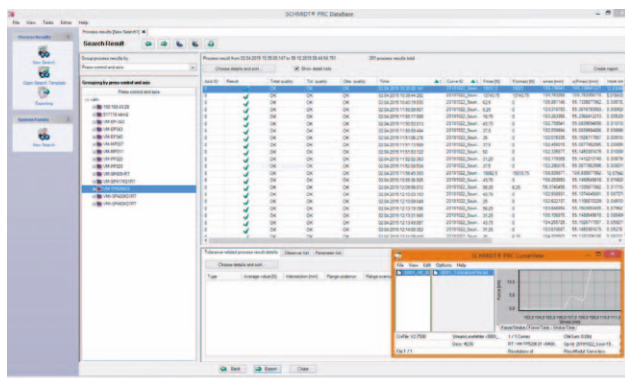
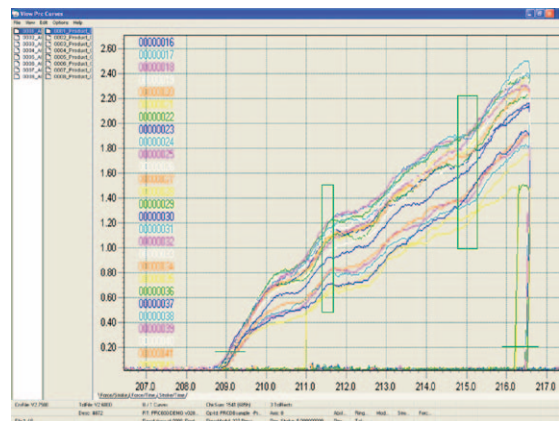

- Characteristics**
- Documentation
  - Analysis
  - Quality assurance
  - Traceability
  - Data export in CSV format
  - Q-DAS interface with certification

# SCHMIDT® PRC FileXchange

## Safe exchange of process data

In addition to data exchange within an automation solution via Fieldbus, data exchange can also be performed via data files. For every press process all relevant process results, tolerances, observer, and parameters are written into a file whose format and content can be configured via an intuitive user interface.

The following output formats are available:

- Microsoft Excel (CSV)
- Q-DAS
- SCHMIDT® CRV/TOL
- XML

The transmission of production data is synchronized from PressControl to PC (File System). That means if the connection between PressControl and PC is interrupted the process is stopped, the event is recorded and the process is stopped. Once the connection is re-established the data of the last press process will be transmitted again.

It is also possible to import default values for press processes from a configuration file. A production range which comprises several different products can for example be managed via standard PC application and thus be used as production data base.

The respective product-specific configuration file can be created by the SCHMIDT® PressControl HMI for all relevant process parameters and transferred to the customer's management software via xml file.

### export

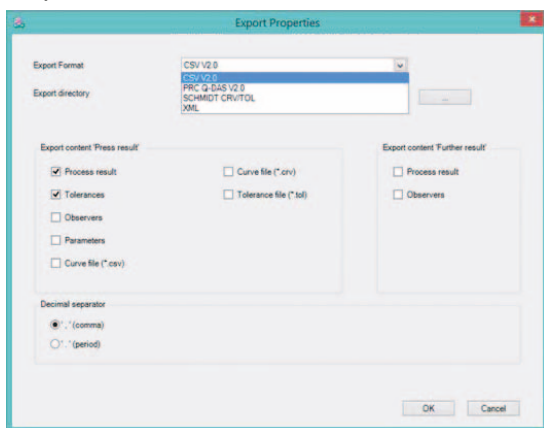

Configuration of output format and content

Storage of the results in a dedicated directory

Transfer to the target system for evaluation and further processing

▼

visualization example

user

### import

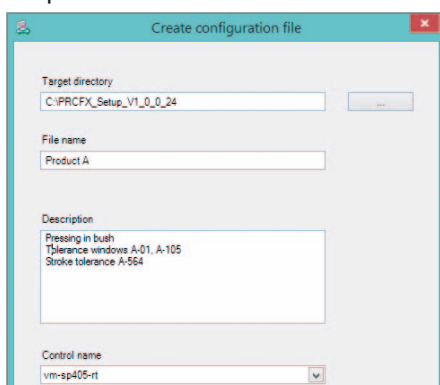

Generating configuration files  
(Parameters for particular joining processes)

Management of product configuration files

▼

Transfer of process parameters via xml-file

user

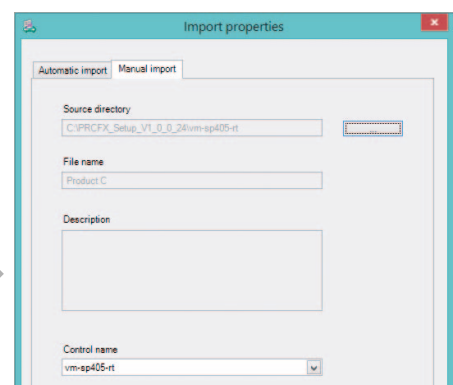

Automatic or manual import into the press control



# SCHMIDT® PRC DataXchange

## Bi-directional data exchange with higher-level controls

The **PRC DataXchange** interface is available for communication between a **SCHMIDT® press system** and a higher-level control system.

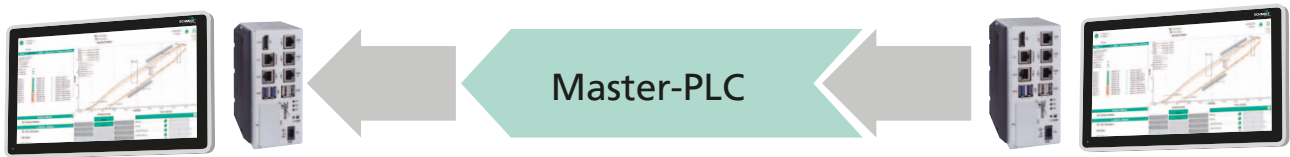

### DataXchange Input

Parameter-Transfer to PressControl  
Dynamic adaptation of processes

- Control type (force, stroke, ext. signal, relative position, ...)
- Position
- Speed
- Force
- Motion block change (stopping, flying, ext. trigger signal)
- Dwell time

### DataXchange Output

Data-Transfer to Master PLC  
for connection to MES and ERP systems

- Reached position
- Reached force
- Actual values position and force
- Curve results
- Tolerance values
- Status signals of the system
- Error states
- Press axis information

# SCHMIDT® PRC OpenFieldBus

**OpenFieldBus** allows a completely free specification and programming of driving profiles and sequences by a master control as well as the bidirectional transmission of all relevant data. To implement individual requirements in the press process, the complete command set can be accessed. At the same time, the advantages of the integrated force-stroke monitoring and control of the press system with all evaluation functions can be utilized

### Characteristics

- Access to the entire command set of the **SCHMIDT® press control**
- Transmission of process results to the master controller
- Individual definition of joining processes, driving sets and data exchange

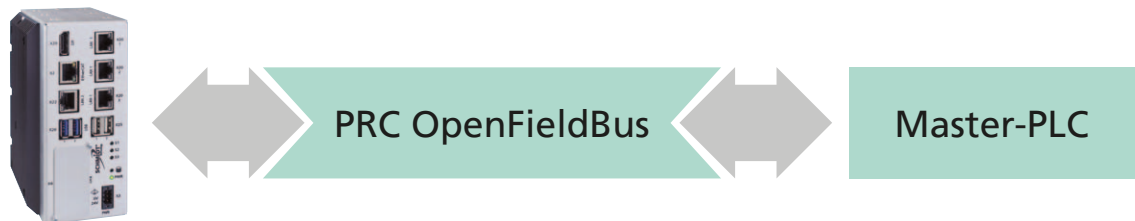

# Data exchange via SCHMIDT® PRC OPC

OPC represents a universal and manufacturer-independent possibility for data transmission used for industrial applications.

The OPC server retrieves relevant process data via Ethernet based on the communication protocol of the **SCHMIDT® PressControl** and makes it available as OPC objects. The OPC client can use all the relevant data items provided by the server and use it for analysis or control according to customer requirements.

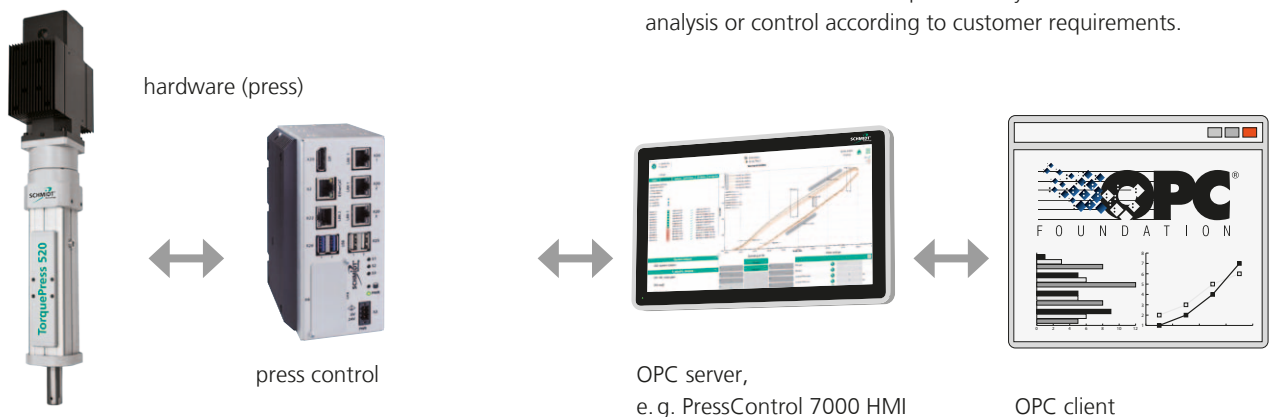

# SCHMIDT® Hardware-Tools

## Proven components for system integration

**SCHMIDT® PressControl 700 and 7000** communicate with higher-level control systems via a standardized interface program. All relevant system states as well as bad part detection performed by simple signal exchange from one control to the other.



### SCHMIDT® PRC Gateway

- EtherCAT-connections to PressControl (Master) und PDA (Slave), with 24V-power supply via EtherCAT-P
- 24 V-Interface with 16 inputs and 16 outputs (up to 0,5A / output)
- short circuit proof and overload protected
- status-LEDs for EtherCAT-Bus and In- / outputs
- encoder-interface
- interface for external hand wheel as handheld
- top-hat rail mounting



External handwheel as handheld for **SCHMIDT® PressControl 700 and 7000 RT** in combination with **SCHMIDT® ElectricPress** with process monitoring or **SCHMIDT® ServoPress/TorquePress**, connection via **SCHMIDT® PRC Gateway**

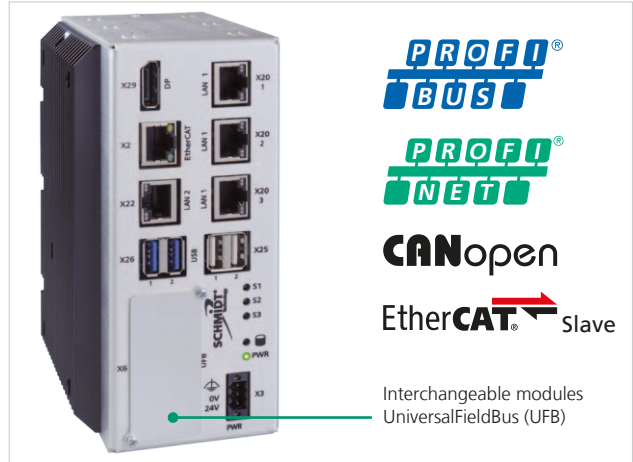

### Communication via fieldbus-systems

All common physical interfaces can be used for signal exchange with the automation environment.

- interchangeable modules UniversalFieldBus (UFB)
- further fieldbus interfaces via external gateway
- USB



### EtherCAT-P Compact Box

- 8 digital channels, usable as inputs or outputs
- signal connection by screwing via M8 plug connector
- power supply (24 V) via EtherCAT-P
- load currents of the outputs up to 0.5 A
- total current of all outputs 3 A

# SCHMIDT® PressControl

## System architecture

SCHMIDT® PressControl does work as a system control and takes over the process monitoring. The hard- and software components forming a system concept with real time characteristics. This is guaranteed by a system architecture with CANopen fieldbus. Press force monitored SCHMIDT® ManualPress,

SCHMIDT® (Hydro-)PneumaticPress, SCHMIDT® ElectricPress or SCHMIDT® ServoPress/TorquePress will be activated via fieldbus. The collected measuring data as well as in-/output data will be exchanged by the fieldbus.

## SCHMIDT® PressControl 700

### system architecture

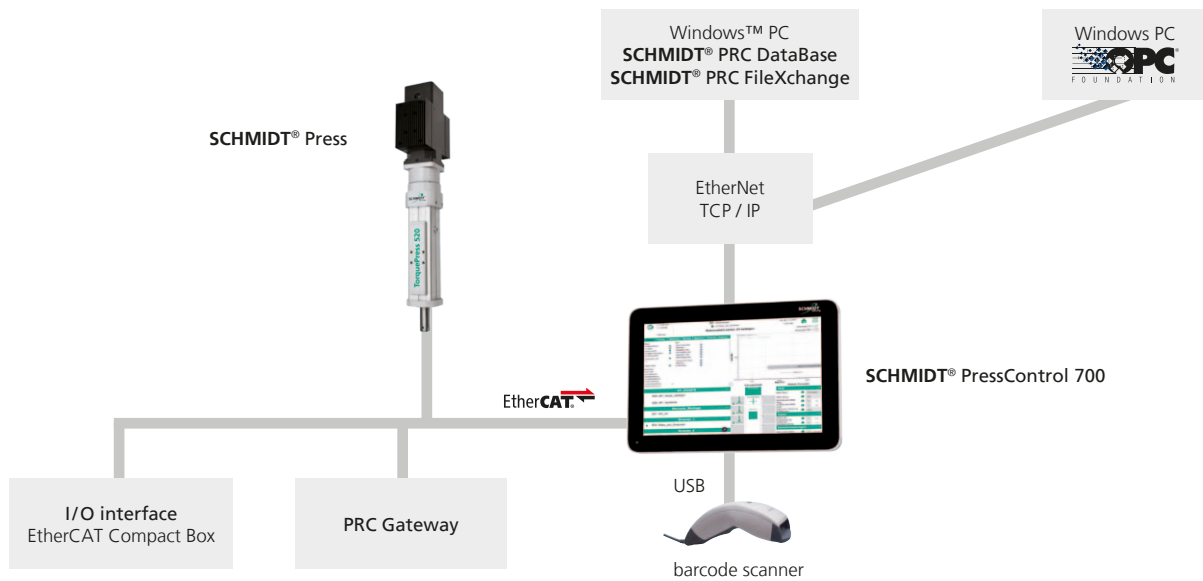

## SCHMIDT® PressControl 7000 RT mit 7000 HMI oder 700 HMI

### system architecture

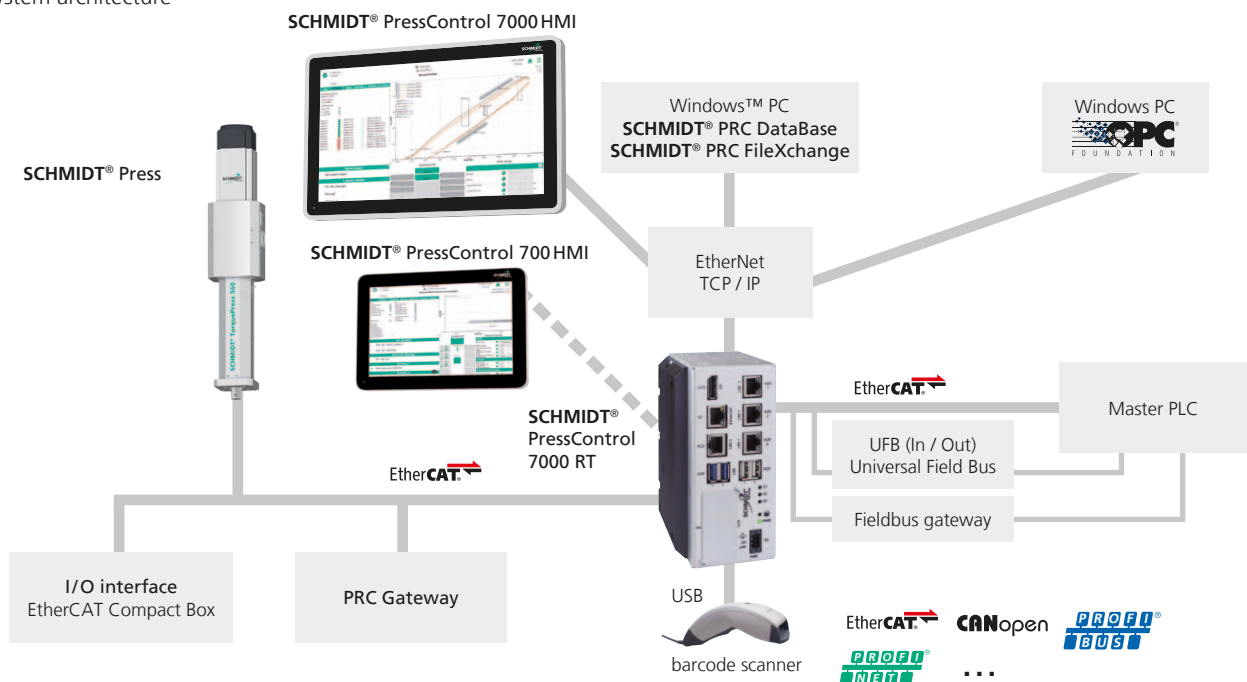

# SCHMIDT® Single Workstations

## Ergonomics with certified safety technology

SCHMIDT® workstations are supplied ready for purpose with certified safety technology and corresponding operating elements. Depending on customer requirements, workstations can be equipped with the following security concepts:

- SCHMIDT® SmartGuard protection cover
- SCHMIDT® SmartGate protective housing with automatic doors
- light curtain
- two-hand safety

The delivery includes:

- Module SCHMIDT® presses mounted on stand or pedestal
- SCHMIDT® PressControl 75 (in two-hand release and light curtain versions), 700 or PressControl 7000 with pendant arm system
- Press base PU 20 / PU 40 in rigid or height-adjustable design, depending on the safety concept optional or as standard

All systems are EC type-approved!

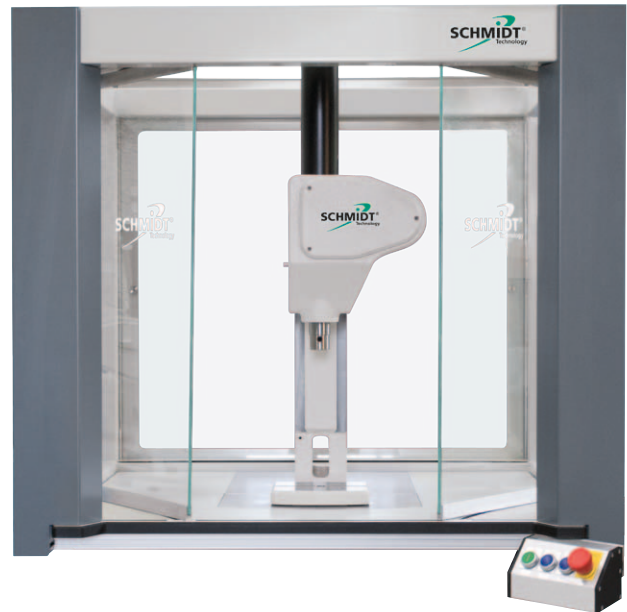

# SCHMIDT® SmartGate

## Shorter process cycles and increased safety standards

SmartGate is a protective enclosure with automatic doors. The access to the process area is via two transparent, horizontally guided door elements. Key benefits of SmartGate over other safety concepts, such as light curtain or two-hand systems, are the significant increase in ergonomics and workflow efficiency through reduction of required safety margins and the excellent accessibility of the process space.

SmartGate sets new standards in the field of safety by completely closing of the process area, completely eliminating unintentional third-party intervention or fragmentation. SmartGate is particularly suitable for processes with the risk of splintering due to protection against flying parts or spalling.

When designing SmartGate, we ensured that all surfaces are as easy to clean as possible and that there are no areas where residues or particles can accumulate. High demands on purity and cleanliness, as they occur, for example, in applications in medical technology can therefore be easily met.

SmartGate		
Max. opening width	720	mm
Variable speed	50 – 350	mm/s
Typical opening time	2.2 s	
Typical closing time	1.8 s	
Noise emission	< 60	dB(A)
Cell size 1	1010 x 883	mm
Cell size 2	1010 x 1049	mm
Protective door	laminated safety glass (VSG)	
Safety category	Ple	



### Characteristics

- Protection of the working area from unintentional intervention
- Splinter protection from chipping of parts
- Visible working space
- Optimization of the safety distances to the complete danger area
- Consideration of quality assurance requirements (NIO behaviour)
- Cycle time and process optimization through programmable opening and closing speed (<2 s)
- Very high energy efficiency due to linear motor drive
- Type approved

# SCHMIDT® Safety Technology

## Smart Safety Concept for Servo and Torque presses

The transparent protective housing entirely encloses the working area during the press process. It thus prevents the user and a third person from getting their hands into the danger area and efficiently protects against the particles or splinters that may be ejected. The distances to the working zone are minimized which considerably improves the ergonomics and the efficiency of the workstations. The high dynamics of the protective housing with numerical control and its variable positioning capability and traversing velocity optimize the process cycle. The smart construction prevents any trap points in the enclosure.

**SCHMIDT® SmartGuard** is a protective shield for **TorquePress 520**, **TorquePress 560** and **ServoPress 605 to 620**.

SmartGuard	type	SP 605	SP 616	SP 617	SP 620	TP 520
Variable opening stroke	mm	280	350	410	500	390
Speed opening	mm/s	200 - 1000				
Speed closing	mm/s	200 - 500				
Drive	type	linear motor				
Min. cycle	s	6				
Deep	mm	434	485	573	644	599
Wide	mm	232	286	312	359	343
Height	mm	1018	1111	1440	1840	1640
Locking position <i>closed</i>		active				
Material guard	PC	antistatic / transparent				
Electr. safety lock		Ple				



### Characteristics

- Protection of the working area from unintentional intervention
- Splinter protection from chipping of parts
- Visible working space
- Optimization of the safety distances to the complete danger area
- Consideration of quality assurance requirements (NIO consideration)
- Cycle time and process optimization through programmable opening and closing speed (<2 s) and the opening height
- Very high energy efficiency due to linear motor drive
- Type approved
- ESD version possible

# Classic Safety Concepts

## Light curtain with transparent protective housing

The light curtain control provides optimum safety to the user. The process area is protected with Makrolon windows against contact. A light curtain protects the access to the hazard area on the side of insertion. The working process is immediately interrupted and the press is stopped when intervening. The cycle can be continued automatically after leaving the danger area. In combination with **SCHMIDT® ServoPress**, the light curtain control is the basic version. The press can be activated via the light curtain. Depending on the application, it can be selected between 1-cycle and 2-cycle activation.



## Two-hand safety technology

In basic design, **SCHMIDT® PneumaticPress**, **SCHMIDT® Hydro-PneumaticPress** as well as **SCHMIDT® ElectricPress** are operated with **two-hand safety technology**. The user must keep both switches in release position. If one switch is released ahead of time, the press stroke is interrupted. This applies to all positions above the automatic stroke takeover that is started from the point where the dangerous closing movement is finished. From the stroke takeover, the stroke is continued automatically.



# SCHMIDT® Press Bases

## Ergonomic in focus

SCHMIDT® Press Base PU 20 and PU 40 for a safe and vibration-proof installation of all SCHMIDT® Press Systems.

Both press bases are available in two versions:

- Fixed columns with height adjustable in 10 mm (0.4") increments from 780 to 1080 mm (30.7" – 42.5")
- Infinitely variable motorized height adjustment from 725 to 1075 mm (28.5" – 42.3")

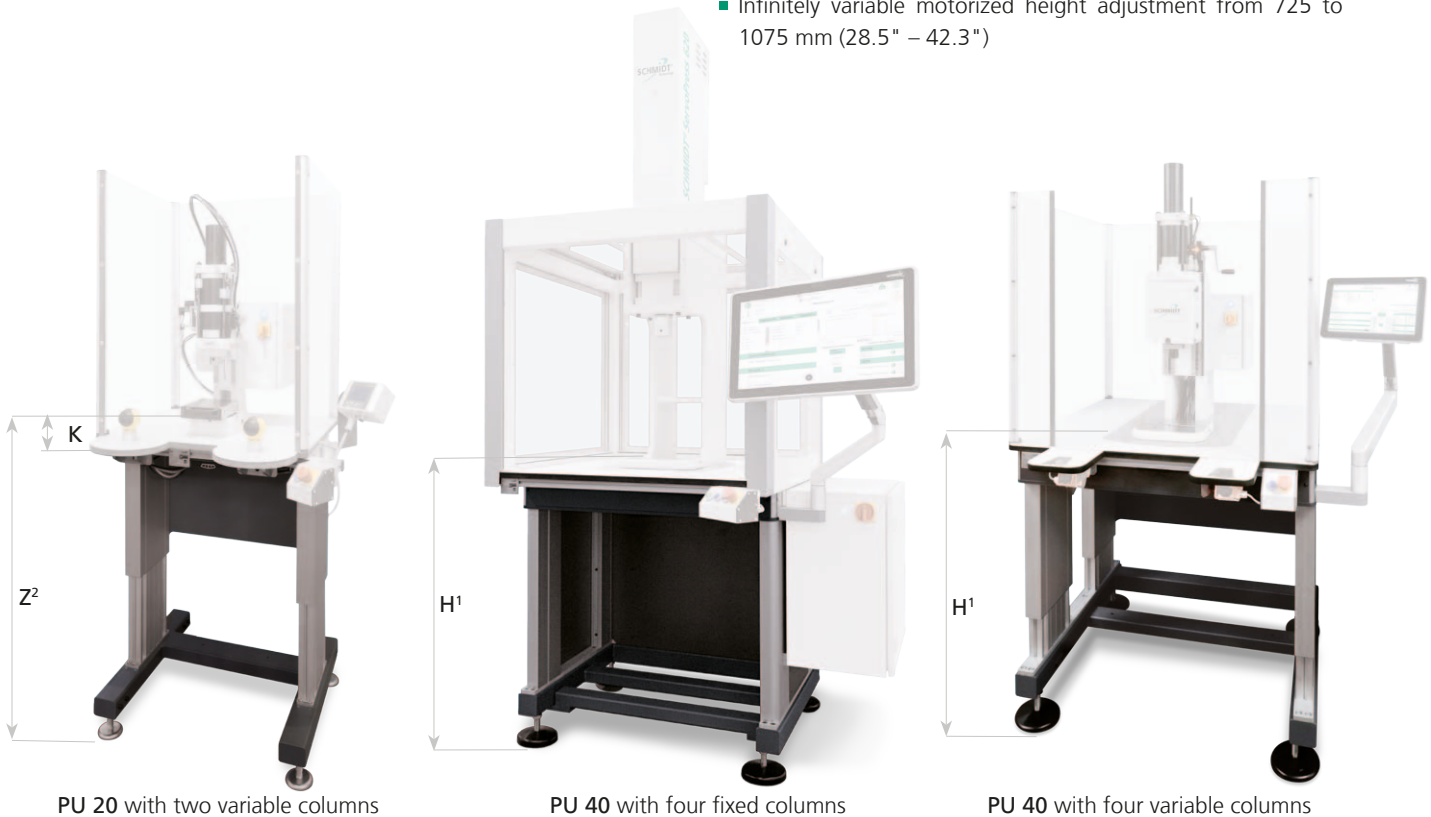

PU 20 with two variable columns

PU 40 with four fixed columns

PU 40 with four variable columns

Technical Data			PU 20 (2 columns)	PU 40 (4 columns)
Fixed columns	H	individually	780 – 1200 mm	780 – 1200 mm
Motorized variable columns	Z	stepless	725 – 1075 mm	725 – 1075 mm
Lifting capacity		kg	600	1200
Width x depth			on request	on request
Foot rest			–	✓

<sup>1)</sup> Height H measured from floor space to press table top

<sup>2)</sup> Fixing dimension Z stand on PU20, resulting height of the press table depends on frame type (see dimension K in the respective press chapters). Example: frame type 3 for press No. 25 K = 60 mm, PU20 (725 mm to 1075 mm) and press table height 60 mm results in total press table infinitely adjustable from 785 mm to 1135 mm

# SCHMIDT® Four-column Gantry

SCHMIDT® Four-column gantries used in manual workstations, and automated assembly lines, are suitable for all SCHMIDT® Presses with extraordinary requirements in all working area.

In order to consider the large number of applications and cases, the design is adapted specifically to your requirements. All individual requirements can be taken into account. Short delivery times are realized because of in-house production. Contact us with dimensions (see table), and we can supply you with a proposal.

### Characteristics base plate

- Coated: RAL 7035 (light-grey)
- Cross T-slot 45° 14<sup>H7</sup>
- Central bore 40<sup>H7</sup>, other bores on request

### Characteristics cover plate

- Coated: RAL 7035 (light-grey)
- Connection drill pattern for the required press
- Chromium-plated columns

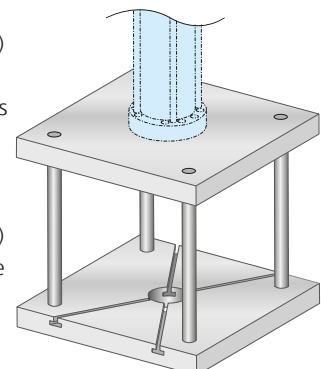



# SCHMIDT® Slide Tables

## For efficient production

SCHMIDT® Slide Tables are specially designed for the high forces of press systems and where a position requires high precision against an adjustable stop. It is an economic solution for tall parts and for placement of parts outside of the danger area. They can be mounted, depending on the type, both in longitudinal and lateral positions, and can be adapted for automated processes.

### Characteristics

- Cross roller bearings for high-precision guidance
- Play-free adjustment of the table guidance is possible
- Maintains its working position via pneumatic cylinders
- Position detection of the slide table via integrated sensors
- Integrated shock absorbers cushion impact at end positions
- Positioning via pneumatic cylinders in automatic mode
- The press stroke is activated only when the slide is in its proper position



**SCHMIDT® Slide Table ST 100M longitudinal with handle**

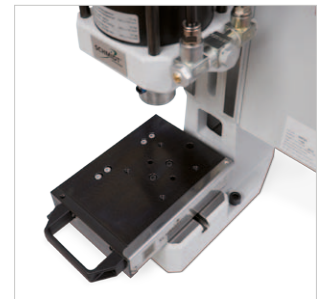

**ST 100M / ST 100P**

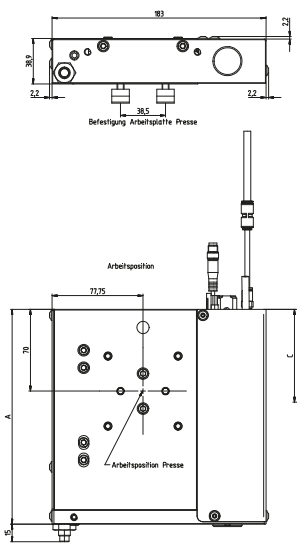

**ST 150M / ST 150P**

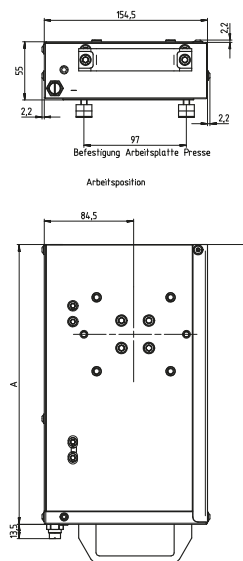

**SCHMIDT® Slide Table ST 100M cross mounting with adapter plate for fastening on the fixture mounting plat**



Type		ST 100M	ST 100P	ST 150M	ST 150P
Pressure load	kN	100	100	150	150
Max. stroke V1	mm	79	80	129	130
Max. stroke V2	mm	159	160	199	200
Repeatability working position	mm	±0.01	±0.01	±0.01	±0.01
Repeatability loading position	mm	±0,2	±0,01	±0,2	±0,01
Dimensions B/H/T V1	mm	142 / 39 / 220	188 / 39 / 211	159 / 55 / 301	159 / 55 / 279
Dimensions B/H/T V2	mm	142 / 39 / 300	188 / 39 / 291	212 / 55 / 271	212 / 55 / 349
Weight V1	kg	3.6	4.2	10.8	12.7
Weight V2	kg	6.9	7.6	11.8	14.1
Max. tool weight	kg	10	10	10	10
Operating mode		manual	pneumatic	manual	pneumatic

# SCHMIDT® Customer-Specific Solutions

Standard 'out of the catalog' products, customized or complete turn key solutions. **SCHMIDT Technology** is an invaluable source for your assembly needs, with the center point being a press. We welcome the opportunity to evaluate your application, perform feasibility studies, process sample parts to determine process capability from a control, as well as monitoring standpoint.

We can take your applications from process development and manufacturing of prototype tooling to provide you with custom designed, turn-key solutions.

**SCHMIDT®** engineers and sales force have gained a wealth of experience while working on a wide array of applications.

**SCHMIDT Technology** products are suitable for a broad variety of industries and can be tailored to the specific requirements and challenges that applications present, from very basic and simple pressing operations to intelligent, precise and complex processes, combined with monitoring.

The ever rising need to log and exchange process data with third party systems can easily be addressed by the various ways our control systems can be interfaced.

Your need is our challenge. We look forward to the opportunity to be of service.



## SCHMIDT® ElectricPress 43/343 Automation

Integrates easily and quickly into an automated system; ideal for new design concepts, integration or as a replacement in an existing production line.



# SCHMIDT® Customer-Specific Solutions



## „Compliant Pin” application

**SCHMIDT® ServoPress Systems** are the ideal tool for press-fit applications. Their integrated process data and closed-loop force control is perfect for the assembly and disassembly of electronic components. In contrast to soldering, press-fit contacts on a circuit board requires precisely defined and closely monitored assembly processes at very slow speeds. A **SCHMIDT® Press** can be the solution.

All **SCHMIDT® Press Types** can be integrated in a rotary indexing system. Depending on the requirements of the customer, an individual design is planned.

Hybrid Assembly Cell Configuration with

- a monitored PneumaticPress
- a monitored ServoPress
- a conventional HydroPneumaticPress

A single **SCHMIDT® PressControl 7000 RT** can control all of these presses as well as an indexing table. It acquires all stroke/force process data, which can then be transmitted to the **SCHMIDT® DataBase** software for storage and analysis.



## SCHMIDT® Support

Close to the customer thanks to a perfect service

### SCHMIDT® DemoBus

Our press technology will come to your premises. The **SCHMIDT® DemoBus** contains a selection of fully functional presses and accessories.

- See the innovative news and trends
- Get a wide overview over our products
- Do not lose time and save travel costs
- Discuss your assembly applications with our experts
- Conduct trials (by prior arrangements)



### SCHMIDT® CompetenceCenter

We have a large number of presses and press systems in our exhibition and testing area at your disposal. Visitors are welcome to our Competence Center to discuss at first hand their specific requirements with our team of experts, who will be pleased to conduct trials on their tools and offer advice and best solutions for all applications.



### SCHMIDT® TrainingCenter

Our training packages prepare the participants fully in theory and practice for their daily work with **SCHMIDT® Press Systems**, by offering comprehensive user training courses and seminars on complex technological products. These training courses deal with the handling of the products as well as the correct use of the control and process software. **SCHMIDT Technology** stands for high quality products and their efficient use on site.



# SCHMIDT® Services portfolio

We support you either on site and from in-house

In order to meet the high quality standards of modern production, to comply with legal requirements periodic calibrations and safety tests of the press systems according to DIN ISO 9000, safety measures are required.

**SCHMIDT Technology** assists you by means of a strong service package in meeting these requirements.

## SCHMIDT® Calibration

for force-monitored press systems

## SCHMIDT® PressControl

- Checking the measurement system
- Calibration
- Issue of a test certificate incl. test report
- Calibration sticker on the machine

## SCHMIDT® SafetyCheck

for all **SCHMIDT® PressSystems** with type approval

- Test according to the relevant standards
- Measurement and test of the two-hand switching
- Follow-up measurement
- Functional safety check
- General functional check
- Issue of a test report
- Test sticker on the machine

## For Light Curtain Systems

- Additional test according to the relevant standards



## Telephone support

Our service is available Monday through Friday from 7:30 am to 4:30 pm (GMT +1). Emergency telephone assistance and a reaction time within 24 hours are our standard.

## Service Center world wide

### Head Quarter

#### SCHMIDT Technology GmbH

Feldbergstr. 1  
78112 St. Georgen im Schwarzwald  
Germany  
support@schmidttechnology.de  
Phone +49 7724 899 300

### Service Center US – 24/7 Hotline

#### SCHMIDT Technology Corp.

280 Executive Drive  
Cranberry Township, PA 16066  
USA  
service@schmidtpresses.com  
Phone +1 (724) 814-5241

### Service Centre Asia

#### NIXMA TECHNOLOGY CO., LTD.

9/79 Moo 5, Phaholyothin Road, T. Klong Nueng,  
A. Klong Luang, Pathum Thani 12120  
Thailand  
www.schmidt-servicecenter.asia  
Phone +66 2902 2394  
Fax +66 2902 2396

### Service Centre UK

#### APS Ltd

Unit 21, Easter Park  
Benyon Road  
Reading  
Berkshire, RG7 2PQ  
UK  
vincent.small@aps-ltd.co.uk  
Phone +44 777 358 9201

# Our Representations Worldwide

## Addresses of the Subsidiaries and Representations



**Australia, New Zealand**  
Bliss & Reels Co. Pty.  
9 Kim Close  
AU-3105 Bulleen, Victoria  
Fon +61 (3) 98 50 66 66  
sales@blissandreels.com.au

**Austria**  
Maxxom Automation GmbH  
Gewerbegebiet  
Salzweg 1  
A-4894 Oberhofen am Irsee  
Fon +43 6213 20053 0  
office@maxxom-automation.at

**BeNeLux**  
Germo Techniek BV  
Rotterdamseweg 382 A  
NL-2629 HG Delft  
Fon +31 (15) 251 11 10  
pbos@germotechniek.nl

**China**  
Team Tech Auto System (Suzhou) Co., Ltd.  
Sun yuxiang  
Manager for Press Division  
No.12 Li Tang Road, Industrial Park  
Suzhou City of China  
Fon: +86 189 625 11 262  
yuxiang.sun@tt-autos.com

**Czech Republic**  
Presston spol. s.r.o.  
Bozetechova 50  
CZ-61200 Brno  
Fon +420 541 248 853  
presston@presston-stroje.cz

**Denmark**  
HCT Tool A/S  
Baltorpbakken 10  
DK-2750 Ballerup  
Fon +45 70 20 84 84  
tmb@hct.dk

**Finland, Estonia**  
Pneumacon Oy  
Palo-ojantie 5  
05810 Hyvinkää  
Fon +35 810 7781 400  
harri.lindroos@pneumacon.fi

**France**  
SCHMIDT Technology SAS  
6 rue des Frères Lumières  
67170 Brumath  
Fon +33 (0) 3 88 62 68 53  
info@schmidttechnology.fr

**Hungary, Bulgaria, Romania**  
Eckerle Industrie Kft.  
Dózsa György út 44  
HU-6200 Kiskörös  
Fon +36 (78) 511 400  
info@hu.eckerle-gruppe.com

**India**  
LEAPTECH CORPORATION  
812 Cosmos, Sector 11  
CBD Belapur,  
New Mumbai 400 614  
India  
Fon +91(22) 2756 2822  
leaptech@vsnl.net

**Indonesia**  
PT Supra Engineering  
Jl. Pecenongan No. 17 D  
ID-10120 Jakarta  
Fon +62 (21) 345 7469  
atsupra@supra.co.id

**Italy**  
Seica Automation Srl  
Via Kennedy 24  
10019 Strambino (TO), Italia  
Fon +39 0362 1572606  
sales@seica.com

**Israel**  
Tamir Eran Engineering &  
Development Ltd  
7 Hamifalim St. Kiriat-Arie  
48179 Petach-Tikva  
Fon +972 3 922 9422  
tamireng@netvision.net.il

**Japan**  
Naka Seiki Co. Ltd.  
1-2-17 Kinda-cho, Moriguchi-shi  
JP-570-0011 Osaka  
Fon + 81 (06) 69 01 18 75  
honsha@nakaseiki.co.jp

**Malaysia, Philippines, Singapore, Vietnam**  
Preston Technology SDN BHD  
1-12-16, SUNTECH @ Penang  
Cybercity  
Lintang Mayang Pasir 3, Bayan Lepas  
11950 Pulau Pinang, Malaysia  
Fon +60 4-6 38 1701 / 1702  
chang@preston.com.my

**Norway**  
Stang Maskin AS  
Åsveien 2  
N-3475 Sâtre  
Fon +47 66 77 73 10  
post@stang-maskin.no

**Poland**  
Przedsiębiorstwo AMS Sp. z o.o.  
Jagodnik 17C  
PL-58-100 Swidnica  
Fon +48 (74) 853 4715  
ams@ams-at.pl

**Slovakia**  
MTS, spol. s.r.o.  
Krivá 53  
SK-02755 Krivá  
Fon +421 (435) 819 111  
mts@mts.sk

**Slovenia, Croatia, Bosnia, Serbia**  
MB-Naklo d.o.o.  
Ulica Toma Zupana 16  
SI-4202 Naklo  
Fon +386 (0) 4 277 17 00  
mb-naklo@mb-naklo.si

**South Korea**  
Tae Jin Industry Co. Ltd.  
#A - 909 Doksan Hyundai  
Knowledge Industry Center, 70  
Doosan-ro, Geumcheon-gu,  
Seoul, Korea  
Fon +82 (2) 894 88 39  
taejin@schmidt.co.kr

**Spain, Portugal**  
ATSI  
Luis Merelo y Mas, 6  
E-46023 Valencia  
Fon +34 (96) 337 04 00  
atsi@atsi.es

**Sweden**  
Deprag Scandinavia AB  
Gap Sundins Väg 3  
SE-633 46 Eskilstuna  
Fon +46 (16) 1261 10  
info@deprag.se

**Switzerland**  
SCHMIDT Technology GmbH  
Industriestrasse 6  
4528 Zuchwil  
Fon +41 (0)32 513 23 24  
infoCH@schmidttechnology.ch

**Taiwan**  
I-Hen Machine Co. Ltd.  
6F-9, No. 12, Lane 609, Sec. 5  
Chung Hsin Road, San-Chung City  
Taipei  
Fon +886 (22) 999 6766  
ihenco@ms9.hinet.net

Telebox Industries Corp.  
Intelligent AutoPress Dep.  
4F, 306 Tatung Road, Sec.1,  
Hsichih-Taipei 221, Taiwan  
Fon +886 (2) 2642 9337  
Samuel.Chang@schmidtpresses.com.tw

**Thailand**  
NIXMA TECHNOLOGY Co., Ltd.  
9/79 Moo 5, Phaholyothin Road, T.  
Klong Nueng, A. Klong Luang, Pathum  
Thani 12120 Thailand  
Fon +66 89 892 4152  
mathew.p@nixma.com

**Tunisia, Morocco, Algeria, Egypt, Jordan, Saudi Arabia, United Arab Emirates**  
EP-Technologie  
29 AV. AHMED TLILI  
Zone Industriell Borj Cedria  
2055 Bir EL Bey -Ben Arous  
TUNISIA  
Fon +216 (79) 41 28 89  
info@EP-Technologie.com

**Turkey**  
Günmak Industrial Tool Pump and  
Automation System Inc.  
Toros Caddesi No. 78  
TR-34846 K.Maltepe - Istanbul  
Fon +90 (216) 370 76 76  
iguner@gunmak.com

**United Kingdom**  
SCHMIDT Technology Ltd.  
Albany House, Shute End,  
Wokingham, Berks RG40 1BJ  
United Kingdom (UK)  
Fon +44 (0) 118930 5464  
sales@schmidttechnology.co.uk

**USA**  
SCHMIDT Technology Corp.  
Cranberry Corporate Center  
280 Executive Drive  
Cranberry Twp., PA 16066  
Fon +1(724) 7 72-46 00  
info@schmidtpresses.com